

NP-series
NP3-MQ000
NP3-MQ001
NP5-MQ000
NP5-MQ001
NP5-SQ000
NP5-SQ001
NP-NPDC0-V1

Programmable Terminal NP-Designer

USER'S MANUAL

OMRON

NP-series

NP3-MQ000

NP3-MQ001

NP5-MQ000

NP5-MQ001

NP5-SQ000

NP5-SQ001

NP-NPDC0-V1

Programmable Terminal NP-Designer

User's Manual

Revised April 2009

Introduction

Thank you for purchasing an NP-series Programmable Terminal.

NP-series PTs are designed to transfer data and information in FA production sites.

Please be sure that you understand the functions and performance of the PT before attempting to use it.

Intended Audience

This manual is intended for the following personnel, who must also have knowledge of electrical systems (an electrical engineer or the equivalent).

- Personnel in charge of introducing FA systems into production facilities.
- Personnel in charge of designing FA systems.
- Personnel in charge of installing and connecting FA systems.
- Personnel in charge of managing FA systems and facilities.

General Precautions

This manual provides information for connecting and setting up an NP-series PT. Be sure to read this manual before attempting to use the PT and keep this manual close at hand for reference during installation and operation.

© OMRON, 2008

All rights reserved. No part of this publication may be reproduced, stored in a retrieval system, or transmitted, in any form, or by any means, mechanical, electronic, photocopying, recording, or otherwise, without the prior written permission of OMRON.

No patent liability is assumed with respect to the use of the information contained herein. Moreover, because OMRON is constantly striving to improve its high-quality products, the information contained in this manual is subject to change without notice. Every precaution has been taken in the preparation of this manual. Nevertheless, OMRON assumes no responsibility for errors or omissions. Neither is any liability assumed for damages resulting from the use of the information contained in this publication.

Read and Understand this Manual

Please read and understand this manual before using the product. Please consult your OMRON representative if you have any questions or comments.

Warranty and Limitations of Liability

WARRANTY

OMRON's exclusive warranty is that the products are free from defects in materials and workmanship for a period of one year (or other period if specified) from date of sale by OMRON.

OMRON MAKES NO WARRANTY OR REPRESENTATION, EXPRESS OR IMPLIED, REGARDING NON-INFRINGEMENT, MERCHANTABILITY, OR FITNESS FOR PARTICULAR PURPOSE OF THE PRODUCTS. ANY BUYER OR USER ACKNOWLEDGES THAT THE BUYER OR USER ALONE HAS DETERMINED THAT THE PRODUCTS WILL SUITABLY MEET THE REQUIREMENTS OF THEIR INTENDED USE. OMRON DISCLAIMS ALL OTHER WARRANTIES, EXPRESS OR IMPLIED.

LIMITATIONS OF LIABILITY

OMRON SHALL NOT BE RESPONSIBLE FOR SPECIAL, INDIRECT, OR CONSEQUENTIAL DAMAGES, LOSS OF PROFITS OR COMMERCIAL LOSS IN ANY WAY CONNECTED WITH THE PRODUCTS, WHETHER SUCH CLAIM IS BASED ON CONTRACT, WARRANTY, NEGLIGENCE, OR STRICT LIABILITY.

In no event shall the responsibility of OMRON for any act exceed the individual price of the product on which liability is asserted.

IN NO EVENT SHALL OMRON BE RESPONSIBLE FOR WARRANTY, REPAIR, OR OTHER CLAIMS REGARDING THE PRODUCTS UNLESS OMRON'S ANALYSIS CONFIRMS THAT THE PRODUCTS WERE PROPERLY HANDLED, STORED, INSTALLED, AND MAINTAINED AND NOT SUBJECT TO CONTAMINATION, ABUSE, MISUSE, OR INAPPROPRIATE MODIFICATION OR REPAIR.

Application Considerations

SUITABILITY FOR USE

OMRON shall not be responsible for conformity with any standards, codes, or regulations that apply to the combination of products in the customer's application or use of the products.

At the customer's request, OMRON will provide applicable third party certification documents identifying ratings and limitations of use that apply to the products. This information by itself is not sufficient for a complete determination of the suitability of the products in combination with the end product, machine, system, or other application or use.

The following are some examples of applications for which particular attention must be given. This is not intended to be an exhaustive list of all possible uses of the products, nor is it intended to imply that the uses listed may be suitable for the products:

- Outdoor use, uses involving potential chemical contamination or electrical interference, or conditions or uses not described in this manual.
- Nuclear energy control systems, combustion systems, railroad systems, aviation systems, medical equipment, amusement machines, vehicles, safety equipment, and installations subject to separate industry or government regulations.
- Systems, machines, and equipment that could present a risk to life or property.

Please know and observe all prohibitions of use applicable to the products.

NEVER USE THE PRODUCTS FOR AN APPLICATION INVOLVING SERIOUS RISK TO LIFE OR PROPERTY WITHOUT ENSURING THAT THE SYSTEM AS A WHOLE HAS BEEN DESIGNED TO ADDRESS THE RISKS, AND THAT THE OMRON PRODUCTS ARE PROPERLY RATED AND INSTALLED FOR THE INTENDED USE WITHIN THE OVERALL EQUIPMENT OR SYSTEM.

PROGRAMMABLE PRODUCTS

OMRON shall not be responsible for the user's programming of a programmable product, or any consequence thereof.

Disclaimers

CHANGE IN SPECIFICATIONS

Product specifications and accessories may be changed at any time based on improvements and other reasons.

It is our practice to change model numbers when published ratings or features are changed, or when significant construction changes are made. However, some specifications of the products may be changed without any notice. When in doubt, special model numbers may be assigned to fix or establish key specifications for your application on your request. Please consult with your OMRON representative at any time to confirm actual specifications of purchased products.

DIMENSIONS AND WEIGHTS

Dimensions and weights are nominal and are not to be used for manufacturing purposes, even when tolerances are shown.

PERFORMANCE DATA

Performance data given in this manual is provided as a guide for the user in determining suitability and does not constitute a warranty. It may represent the result of OMRON's test conditions, and the users must correlate it to actual application requirements. Actual performance is subject to the OMRON Warranty and Limitations of Liability.

ERRORS AND OMISSIONS

The information in this manual has been carefully checked and is believed to be accurate; however, no responsibility is assumed for clerical, typographical, or proofreading errors, or omissions.

Safety Precautions

Notation Used for Safety Information

The following notation is used in this manual to provide precautions required to ensure safe usage of the product.

The safety precautions that are provided are extremely important to safety.

Always read and heed the information provided in all safety precautions.

The following notation is used.



Indicates a potentially hazardous situation which, if not avoided, will result in minor or moderate injury, or may result in serious injury or death. Additionally there may be significant property damage.





Supplementary comments on what to do or avoid doing, to use the product safely.







Supplementary comments on what to do or avoid doing, to prevent failure to operate, or undesirable effect on product performance.

Symbols

	Prohibition Indicates a general prohibition
	Caution Indicates general cautionary, warning, or danger level information

 **WARNING**

<p>After the NP-series PT has been installed, qualified personnel must confirm the installation, and must conduct test operations and maintenance.</p> <p>The qualified personnel must be qualified and authorized to secure safety at each phases of design, installation, running, maintenance, and disposal of system.</p>	
<p>A qualified person in charge, who is familiar with the machine, must conduct and verify the installation of the NP-series PT.</p>	
<p>Do not use the PT touch switch input functions for applications where danger to human life or serious property damage is possible, or for emergency switch applications.</p>	
<p>Do not press two or more touch switches at the same time. If doing so, other switch allocated between these switches may be operated.</p>	
<p>Do not dismantle, repair, or modify the product. Doing so may lead to loss of safety functions.</p>	

Precautions for Safe Use

- When unpacking the Units and peripheral devices, check carefully for any external scratches or other damage. Also, shake the products gently and check for any abnormal sound.
- Always install the Unit in the control panel.
- The mounting panel must be between 1.6 and 2.5 mm thick. Tighten the Mounting Brackets evenly to a torque of 0.7 N·m to maintain water and dust resistance. Make sure the panel is not dirty or warped and that it is strong enough to hold the Units.
- Do not let metal particles enter the Units when preparing the panel.
- Do not connect an AC power supply to the DC power terminals.
- Use reinforced insulation or double insulation for the DC power supply with minimal fluctuation voltage to the Unit. Ensure that a stable power output can be provided even if a 10-ms interruption occurs at the input. Tighten the terminal block screws to a torque of 0.51 N·m.
Rated power supply voltage: 24 VDC (Allowable range: 21.6 to 27.6 VDC)
Capacity: 12 W minimum
- Do not perform a dielectric voltage test.
- Ground the Unit correctly to prevent malfunctions caused by noise.
- Do not touch the surface of the circuit board or the components mounted on it with your bare hands. Discharge any static electricity from your body before handling the board.
- Confirm that the current capacity of the connected device is 250 mA or less before using 5VDC power supply from the pin 6 of the serial port COM1 connectors. The 5VDC output of the Unit is 250 mA maximum at 5 V $\pm 5\%$.
- Turn OFF the power supply before connecting or disconnecting cables.
- The tightening torque of the serial port COM1 is 0.6 N·m.
The tightening torque of the serial port COM2 is 0.2 N·m.
- The maximum tensile load for cables is 30 N. Do not apply loads greater than this.
- Confirm the safety of the system before turning ON or OFF the power supply.
- The whole system may stop depending on how the power supply is turned ON or OFF. Turn ON or OFF the power supply according to the specified procedure.
- Start actual system application only after sufficiently checking screen data, macros, and the operation of the program in the host.
- To ensure the safety of the system, incorporate a program that can check that the Unit is properly operating.
- Before initializing screen data, confirm that existing data is backed up at a computer.
- To use numeric input functions safely, always make maximum and minimum limit settings.
- An image will be burnt onto the screen if the same pattern is continuously displayed for a long period of time (24 hours or longer as a guideline). To prevent screen burn, use a screen saver or switch displays periodically.
- Commercially available and recommended USB Hubs do not have the same specifications as the NP-series PT. Normal operation may not be possible in environments subject to noise or static electricity. When using USB Hubs, be sure to provide sufficient measures to prevent noise and static electricity, or install in a location that is not subject to noise or static electricity.
- Do not connect the USB connector to any device that is not applicable.
- Before connecting the USB connector to a device, make sure that the device is free of damage.
- Do not press the touch switch with a force greater than 30 N.
- Confirm the safety of the system before pressing touch switches.
- Signals from the touch switches may not be input if the switches are pressed consecutively at high speed. Confirm each input before proceeding to the next one.

- Do not accidentally press touch switches when the backlight is not lit or when the display does not appear.
- Do not operate the touch switches with tools including screwdriver.
- Touch panel resistance may change over time, causing the touch points to shift. Periodically perform the calibration.
- Do not use benzene, paint thinner, or other volatile solvents, and do not use chemically treated cloths.
- When mounting the Battery, be sure to use the correct Battery and mount it correctly.
- Do not attempt to disassemble or short-circuit the battery.
- Dispose of any battery that has been dropped on the floor or subjected to excessive shock.
- When replacing the battery, always backup data before turning off the power to the Unit. If the battery is removed, the data stored in the Unit will be deleted.
- Dispose of the Units and batteries according to local ordinances as they apply.



廢電池請回收

- The backlight in the Unit contains mercury. Do not dispose of the Unit together with waste to be processed at disposal plants. Dispose of the Unit according to all local laws, regulations, and ordinances.
- The backlights of the Units cannot be replaced by the user. Contact your nearest OMRON representative.
- The Unit may not be usable in locations subject to long-term exposure to oil or water. The gasket will deteriorate after long-time use. Inspect the gasket on a regular basis. If deterioration is found, contact your OMRON representative.

Precautions for Correct Use

- Do not install the Unit in the following places:
 - Locations subject to severe changes in temperature
 - Locations subject to temperatures or humidity outside the range specified in the specifications
 - Locations subject to high humidity that may result in condensation.
 - Locations subject to exposure to chemicals.
 - Locations subject to exposure to oil.
 - Locations subject to corrosive or flammable gases
 - Locations subject to excessive shock or vibration.
 - Locations directly subject to wind or rain.
 - Locations subject to strong ultraviolet light.
- Take appropriate and sufficient countermeasures when installing systems in the following locations:
 - Locations subject to static electricity or other forms of noise from other devices
 - Locations subject to strong electromagnetic fields
 - Locations close to power supplies
 - Locations subject to possible exposure to radiation.

Conforming Directive

The NP-series PTs conform to the EMC Directive.

EMC Directive Conformance

OMRON products are designed as electrical devices for use built into other devices or the overall machine. As individual devices, they comply with the related EMC standards (see note) so that they can more easily be built into other devices or the overall machine. The actual products have been checked for conformity to EMC standards. Whether they conform to the standards in the system used by the customer, however, must be checked by the customer.

EMC-related performance of the OMRON devices will vary depending on the configuration, wiring, and other conditions of the equipment or control panel on which the OMRON devices are installed. The customer must, therefore, perform the final check to confirm that devices and the overall machine conform to EMC standards.

Note Applicable EMC (Electromagnetic Compatibility) standards are as follows:

EMS (Electromagnetic Susceptibility): EN 61131-2

EMI (Electromagnetic Interference): EN 61131-2 (Radiated emission: 10-m regulations)

Complying with EC Directives

NP-series PTs comply with EC Directives. Observe the following precautions to ensure that the customer's device and the overall machine also comply with EC Directives.

1. The PT is designed for installation inside a control panel. The PT must be installed within a control panel.
2. Use reinforced insulation or double insulation for the DC power supply to the PT. Ensure that a stable power output can be provided even if a 10-ms interruption occurs at the input.
3. The PT conforms to the EN 61131-2, but the radiated emission characteristics (10-m regulations) may vary depending on the configuration of the control panel used, other devices connected to the control panel, wiring, and other conditions. You must therefore confirm that the overall machine or equipment complies with EC Directives.
4. The NP-series PTs are Class A products. It may cause radio interference in residential areas, in which case the user may be required to take adequate measures to reduce interference.

Notation and Terminology

The following notation and terminology are used in this manual.

Notation

Reference	Indicates additional information on operation, descriptions or settings.
CS1G-CPU□□-VI	□ used in this manual indicates one character. For example, “CS1G-CPU□□-VI” indicates CS1G-CPU42-VI, CS1G-CPU43-VI, CS1G-CPU44-VI and CS1G-CPU45-VI.

Terminology

PT	In this manual, indicates an NP-series Programmable Terminal.
NP Series	Indicates products in the OMRON NP□□ Series of Programmable Terminals, unless otherwise specified.
PLC	Indicates a Programmable Controller in the OMRON SYSMAC CP, CS/CJ, C, or CVM1/CV Series of Programmable Controllers.
CP Series	Indicates products in the OMRON SYSMAC CP Series of Programmable Controllers: CP1L and CP1H.
CS/CJ Series	Indicates Programmable Controllers in the OMRON SYSMAC CS/CJ Series of Programmable Controllers: CS1G, CS1H, CS1G-H, CS1H-H, CJ1G, CJ1M.
C Series	Indicates products in the OMRON SYSMAC C Series of Programmable Controllers: C200HX(-Z), C200HG(-Z), C200HE(-Z), CQM1, CQM1H, CPM1A, CPM2A, CPM2C.
CVM1/CV Series	Indicates products in the OMRON SYSMAC CVM1/ CV Series of Programmable Controllers: CV500, CV1000, CV2000, CVM1
Serial Communications Unit	Indicates a Serial Communications Unit for an OMRON CS/CJ-series PLC.
Serial Communications Board	Indicates a Serial Communications Board for an OMRON CS/CJ-series or CQM1H PLC.
Communications Board	Indicates a Communications Board for an OMRON C200HX/HG/HE(-Z) PLC.
CPU Unit	Indicates a CPU Unit in the OMRON SYSMAC CP, CS/CJ, C, or CVM1/ CV Series of Programmable Controllers.
NP-Designer	Indicates the OMRON CP-Designer (NP-NPDC0-V□).
Host	Indicates a device such as PLC functioning as the control device and interfaced with the NP-series PT.

About this Manual:

Section 1 Overview

This section provides an overview of the NP-series PTs, including functions, features, connection types, and communications methods.

Section 2 Part Name and Functions

This section describes the part names and functions of the PT.

Section 3 Installing the PT and Connecting Peripheral Devices

This section describes the methods used to install the PT and connect peripheral devices.

Section 4 System Menu

This section describes the methods used to set and check various settings in the system menu of the PT.

Section 5 Installing and Starting the NP-Designer

The software “NP-Designer” is required to create screen data for the PT. This section describes the methods for installing and starting the NP-Designer.

Section 6 NP-Designer Functions

This section describes functions of the NP-Designer.

Section 7 Maintenance and Troubleshooting

This section describes the maintenance and inspection methods for preventing errors occurring, and troubleshooting measures when errors occur in the PT.

Appendices

This section describes hardware specifications and methods for preparing connections cables, and provides lists of standard products.

Related Manuals

The following table lists the device and software manuals used for reference.

Device/Software	Manual name	Catalog No.
NP Series	User's Manual (This manual)	V096
	Host Connection Manual	V102
PLC	SYSMAC CP Series CP1L CPU Unit Operation Manual	W462
	SYSMAC CP Series CP1L CPU Unit Programming Manual	W451
	SYSMAC C200HX/HG/HE(-Z) Installation Guide	W302
	SYSMAC C200HX/HG/HE Operation Manual	W303
	SYSMAC C200HX/HG/HE(-ZE) Operation Manual	W322
	SYSMAC CQM1 Operation Manual	W226
	SYSMAC CQM1H Operation Manual	W363
	SYSMAC CV Series CV500/CV1000/CV2000/CVM1 Programming Manual: Ladder Diagrams	W202
	SYSMAC CPM1A Operation Manual	W317
	SYSMAC CPM2A Operation Manual	W352
	SYSMAC CPM1/CPM1A/CPM2A/CPM2C/SRM1(-V2) Programming Manual	W353
	SYSMAC CPM2C Operation Manual	W356
	SYSMAC CS Series CS1G/H-CPU□□ Operation Manual	W339
	SYSMAC CS/CJ Series Serial Communications Boards and Serial Communications Units Operation Manual	W336
	SYSMAC CJ Series Operation Manual	W393
	SYSMAC CS/CJ Series Programming Manual	W394
	SYSMAC CS/CJ Series Instruction Reference Manual	W340
SYSMAC CS/CJ Series Programming Console Operation Manual	W341	
SYSMAC CS/CJ Series Communications Command Reference Manual	W342	
Programming Devices/ Software	SYSMAC Support Software Operation Manual: C-series PLCs	W248
	SYSMAC Support Software Operation Manual: CVM1 PLCs	W249
	SYSMAC CPT Operation Manual	W333
	CX-Programmer User Manual	W437
	EJ1 Modular Temperature Controller User's Manual	H142

TABLE OF CONTENTS

SECTION 1

Overview	1
1-1 NP-series PT Functions and Operations	2
1-2 Communications with the Host	4
1-3 System Configuration	6
1-4 Procedure for Running NP-series PTs	7

SECTION 2

Part Names and Functions	9
2-1 Part Names	10
2-2 Specifications	14

SECTION 3

Installing the PT and Connecting Peripheral Devices	17
3-1 Installing the PT	18
3-2 Starting the PT	21
3-3 Connecting the NP-Designer	22
3-4 Connecting with a 1:1 NT Link	24
3-5 Connecting with 1:N NT Links	29
3-6 High-speed 1:N NT Links	37
3-7 Host Link	43
3-8 Connecting to Temperature Controllers	59
3-9 Using USB Flash Memory	60

SECTION 4

System Menu	63
4-1 Displaying System Menu	64
4-2 Functions of System Menu	65

SECTION 5

Installing and Starting NP-Designer	71
5-1 Preparing	72
5-2 Installing/Uninstalling	73
5-3 Starting/Exiting NP-Designer	74
5-4 Installing USB Drivers for NP-series PTs	75

SECTION 6

NP-Designer Functions	79
6-1 User Interface	80
6-2 Menus	82
6-3 Toolbars	129

TABLE OF CONTENTS

6-4	Object Functions	134
6-5	Macro Function	184
6-6	Control Block and Status Block	215
6-7	Internal Memory	224
 SECTION 7		
Maintenance and Troubleshooting		227
7-1	Maintenance	228
7-2	Inspection and Cleaning	231
7-3	Troubleshooting	233
7-4	Requesting a Replacement PT	237
 Appendices		239
A	Specifications	241
B	Dimensions	245
C	Connecting to RS-422A/485	249
D	Preparing Connecting Cables	251
E	Standard Models	257
F	List of Optional Products	271
 Revision History		273

SECTION 1

Overview

This section provides an overview of the NP-series PTs, including functions, features, connection types, and communications methods.

- 1-1 NP-series PT Functions and Operations 2
 - 1-1-1 PT Functions for FA Manufacturing Sites 2
 - 1-1-2 NP-series PT Operating System 2
- 1-2 Communications with the Host 4
 - 1-2-1 What is an NT Link? 4
 - 1-2-2 Host Link 4
 - 1-2-3 Connecting to a Temperature Controller 4
 - 1-2-4 Communicating with Another Company's PLCs 5
- 1-3 System Configuration 6
 - 1-3-1 Supported Peripheral Devices 6
- 1-4 Procedure for Running NP-series PTs 7

1-1 NP-series PT Functions and Operations

The NP Series offers advanced operator interfaces called Programmable Terminals that can be used to display required information and provide operating capabilities for FA manufacturing sites. This section describes the role and functions of the NP-series PTs for first-time users of Programmable Terminals.

1-1-1 PT Functions for FA Manufacturing Sites

Line Operating Status Monitor Display

NP-series PTs can be used to display information such as the operating status of the system and the devices. Graphs and other indicators can be used to better represent the information and make it easy to understand.

Directions for FA Site Operators

The PTs can be used to inform the operators of system and device errors and assist them in taking appropriate measures.

Control Panel Switches

The NP-series PTs allow the user to create various on-screen switches. By using touch switch inputs, operating results can be sent to the host.

1-1-2 NP-series PT Operating System

Transferring Screen Data

The screen data displayed on NP-series PTs is created using the NP-Designer on a computer and transferred to the PT through RS-232C or USB communications.

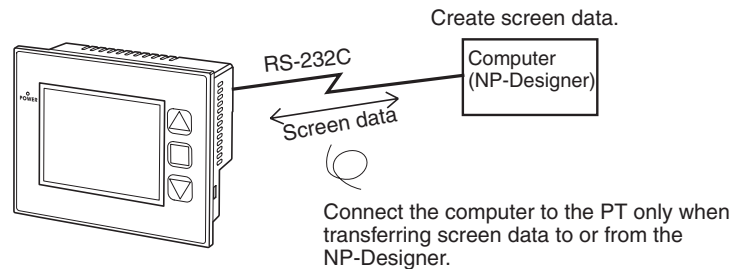

Screen data can also be transferred at high speed using a USB flash memory.

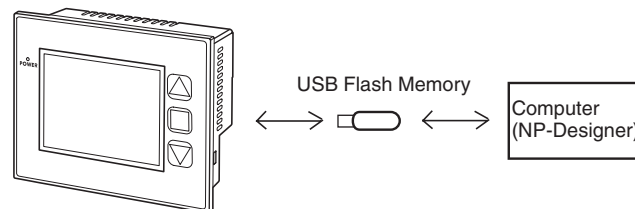

Displaying Screens

The information displayed on the screens is created using the NP-Designer on a computer and transferred to the PT. The required screens can be displayed by using commands from the host or touch switch operations.

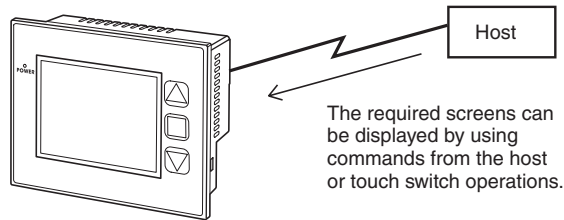

Reading Data from the Host

A communications method such as NT Link is used to connect the host, and the required data is automatically read from the host.

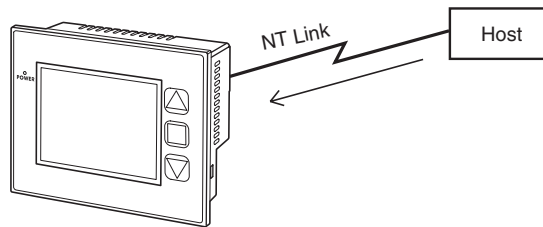

Sending Data to the Host

Data input using touch switches (button ON/OFF status, numerals, and character strings) is sent to the host.

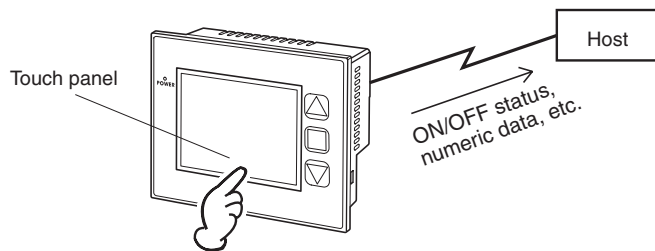

1-2 Communications with the Host

NP-series PTs allow the user to allocate words and bits in any PLC area for use in accessing the required display contents and storing input data.

Operations that can be performed include reading and writing allocated word contents and bit status directly, changing the display status of objects on the PT screen, and controlling and providing notification of the PT status.

The NP-series PTs also enable communications with more than one PLC. A host name is registered for each PLC connected, allowing access to any PLC areas by specifying the host name and address.

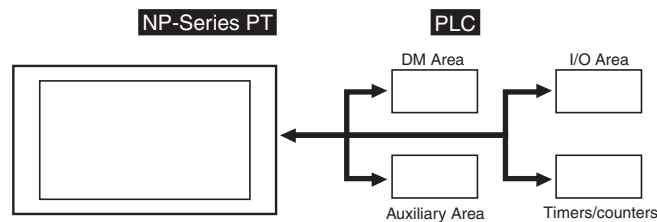

When using NP-series PTs, the host can be connected using any of the following methods.

- 1:1 NT Link
- 1:N NT Link (normal or high-speed)
- Host Link

1-2-1 What is an NT Link?

An NT Link is a method for high-speed communications between an OMRON PLC and an OMRON Programmable Terminal (PT) using a special protocol.

One NP-series PT can be connected to each host. More than one NP-series PT cannot be connected to the same host. Also, if an NP-series PT is connected, then a PT that supports 1:N NT Links and PLC slaves that support Serial PLC Links cannot be connected.

NP-series PTs can be connected to a host using either the 1:1 NT Link protocol or the 1:N NT Link protocol.

CS/CJ-series and CP-series PLCs can also be connected using high-speed 1:N NT Link communications. For details on the PLCs that support high-speed 1:N NT Link communications, refer to *Appendix E Standard Models*.

In the rest of this manual, “NT Link” refers to NT Link communications in general, “1:1 NT Link” refers to an NT Link in a 1:1 configuration only, and “1:N NT Links” refers to NT Links in a 1:N configuration only. Where necessary, “normal 1:N NT Links” and “high-speed 1:N NT Links” are used. When “1:N NT Links” is used alone, it refers to both normal and high-speed communications.

1-2-2 Host Link

Host Link is a serial communications protocol for connecting an OMRON PT 1:1 to an OMRON host (a PLC) to read and write bits and words from the host. Host Link communications connect a PT to many different PLCs.

1-2-3 Connecting to a Temperature Controller

OMRON EJ1 Modular Temperature Controllers can be connected with an RS-485 connection.

Use serial port COM2.

1-2-4 Communicating with Another Company's PLCs

The NP-series PTs can communicate with another company's PLCs. For details on manufactures and models of the supported PLCs, refer to *NP Series Host Connection Manual*.

1-3 System Configuration

The following information describes the system configuration using NP-series PTs. Refer to *Appendix E Standard Models* for details on available models.

1-3-1 Supported Peripheral Devices

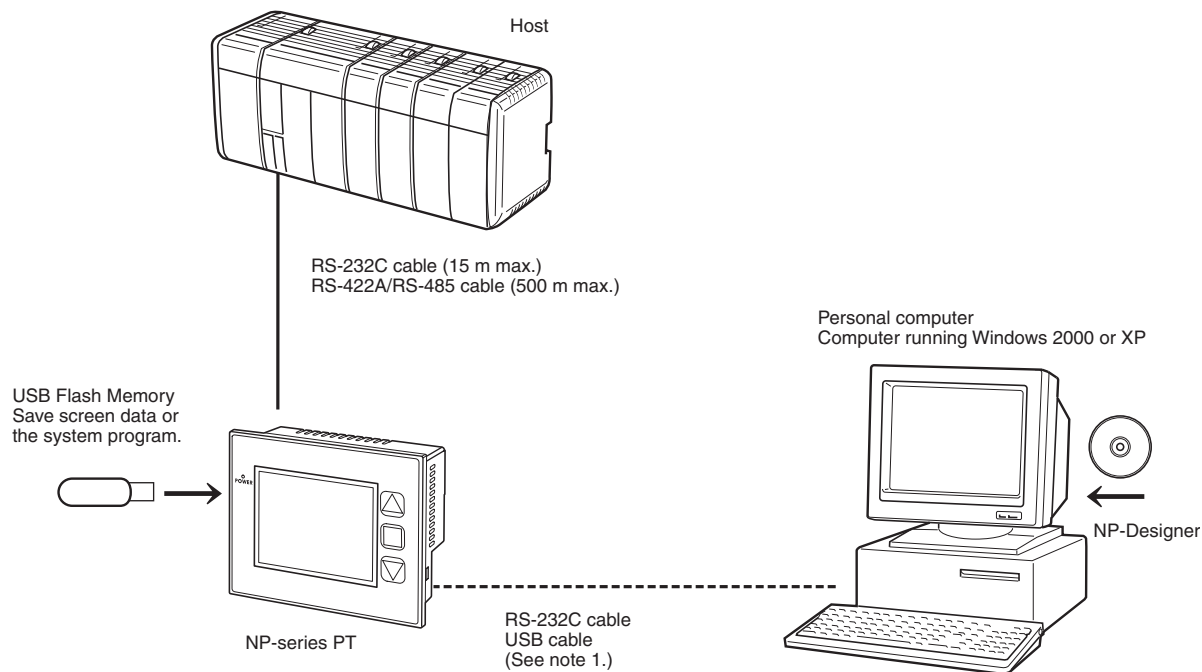

*1 Refer to 3-3-2 *Connecting via USB* for information on connecting the PT and computer with a USB cable.

PTs (Refer to *Appendix E Standard Models*.)

USB flash memory Only FAT32 formatted USB flash memory can be connected.

NP-Designer NP-NPDC0-V1 (CD-ROM version)

Reference The following optional products are available. (Refer to *Appendix F List of Optional Products*.)

	Manufacture	Model
Replacement Battery	OMRON	CJ1W-BAT01

1-4 Procedure for Running NP-series PTs

Use the following procedure to start up the NP Series system.

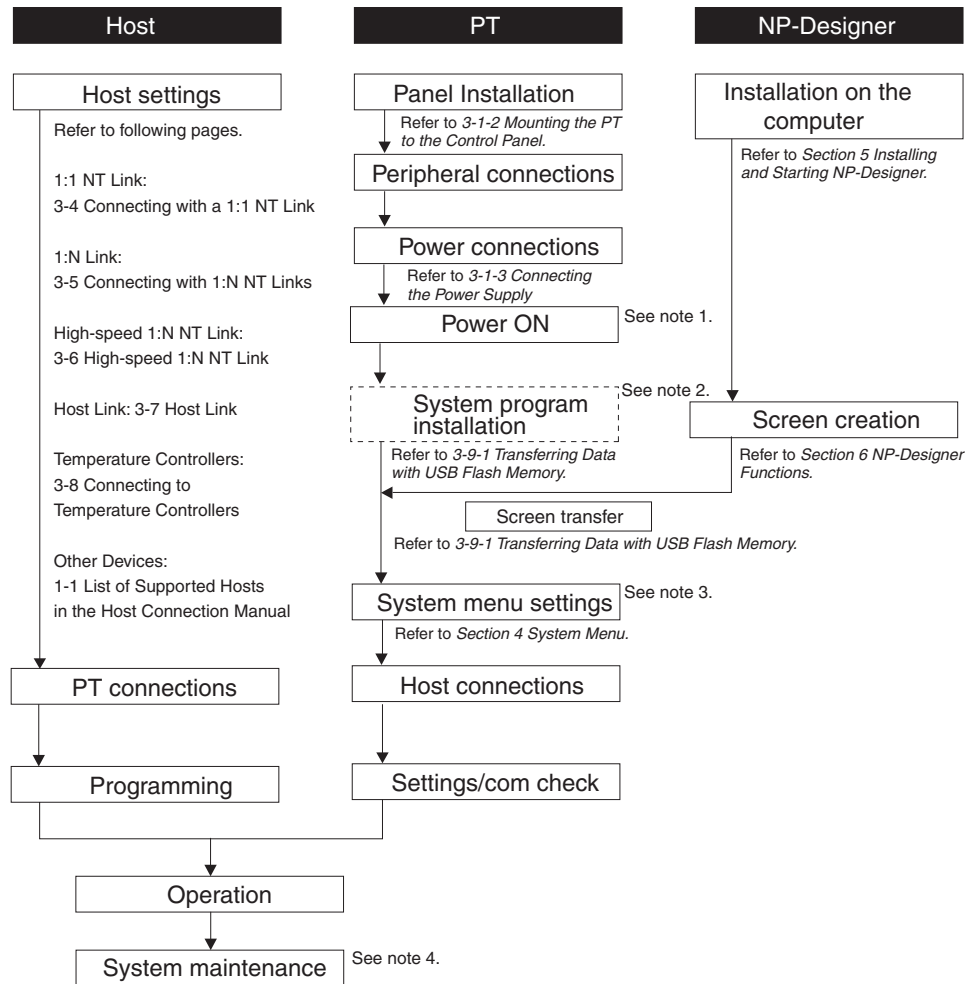

- Note**
- (1) Run mode is entered automatically if screen data already exists.
 - (2) The system program is installed in special situations only, such as when the system program is being changed or recovered.
 - (3) The system menu can be displayed by operating the function switch, button to which system menu is assigned or switch on the back of the PT.
 - (4) When errors occur during operation, check I/O and setting statuses as required.

SECTION 2

Part Names and Functions

The part names and functions of the PT are described here.

2-1	Part Names	10
2-2	Specifications	14

2-1 Part Names

NP5-MQ000B/MQ000

Front Panel

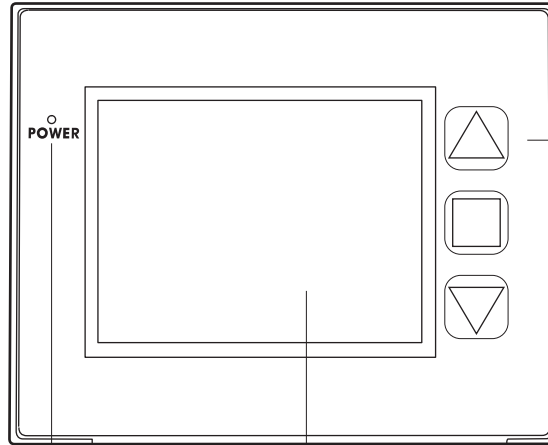

POWER Indicator
The light turns ON/OFF to indicate the ON/OFF condition of the power.

Display
5.7-inch FSTN high luminance LCD
The entire display is a touch panel that serves as an input device.

Function Switch.
Used for input.

Rear Panel

Battery Cover
The battery is installed underneath the cover.

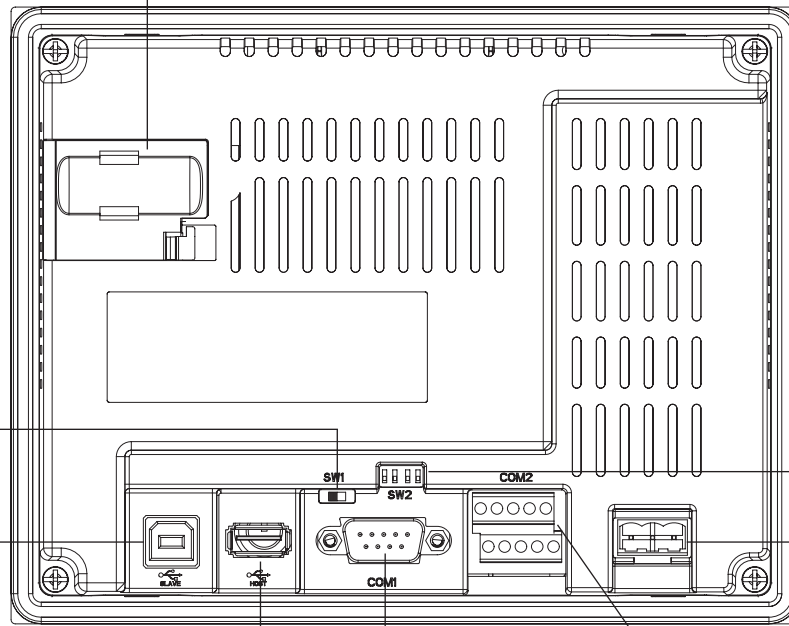

Slide Switch SW1
Used to start the System Menu.

USB Slave Connector
It is a USB Type B connector.

USB Host Connector
This is a USB Type A connector.

Serial Port COM1 Connector
Uses an RS-232C 9-pin connector.

Serial Port COM2 Connector
Uses an RS-422A/485 terminal block.

DIP Switch SW2
Used to switch to RS-422A/485 and set terminating resistance.

DC Input Terminals
Used to connect the 24 VDC power supply.

Precautions for Safe Use

Confirm system safety before turning the power ON/OFF.

NP5-MQ001B/MQ001

Front Panel

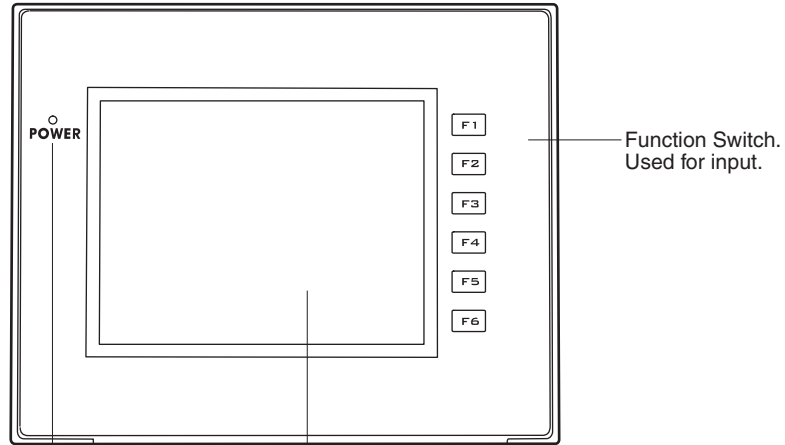

POWER Indicator
The light turns ON/OFF to indicate the ON/OFF condition of the power.

Display
5.7-inch FSTN high luminance LCD The entire display is a touch panel that serves as an input device.

Rear Panel

Battery Cover
The battery is installed underneath the cover.

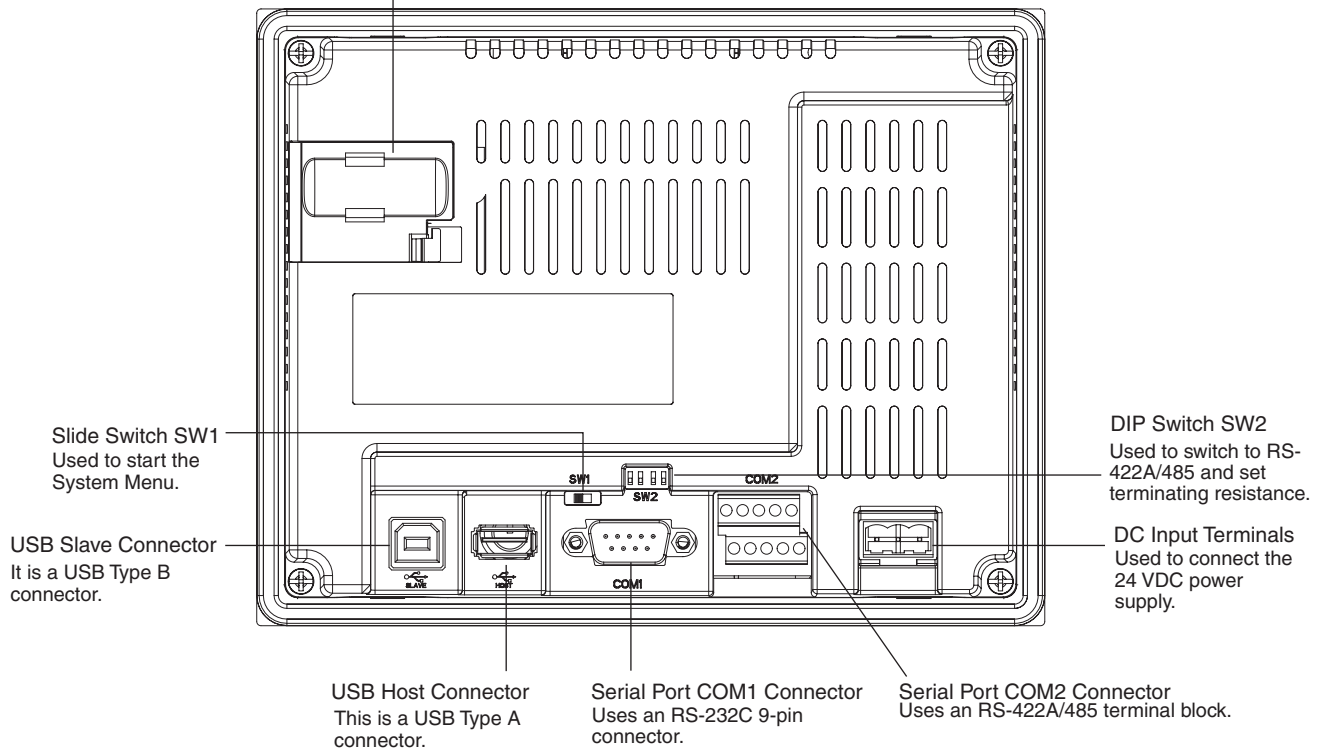

Slide Switch SW1
Used to start the System Menu.

USB Slave Connector
It is a USB Type B connector.

USB Host Connector
This is a USB Type A connector.

Serial Port COM1 Connector
Uses an RS-232C 9-pin connector.

Serial Port COM2 Connector
Uses an RS-422A/485 terminal block.

DIP Switch SW2
Used to switch to RS-422A/485 and set terminating resistance.

DC Input Terminals
Used to connect the 24 VDC power supply.

Precautions for Safe Use

Confirm system safety before turning the power ON/OFF.

NP3-MQ000B/MQ000

Front Panel

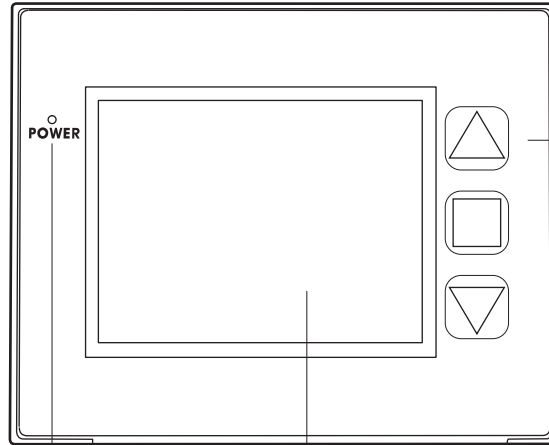

POWER Indicator
The light turns ON/OFF to indicate the ON/OFF condition of the power.

Display
3.8-inch STN high luminance LCD
The entire display is a touch panel that serves as an input device.

Function Switch.
Used for input.

Rear Panel

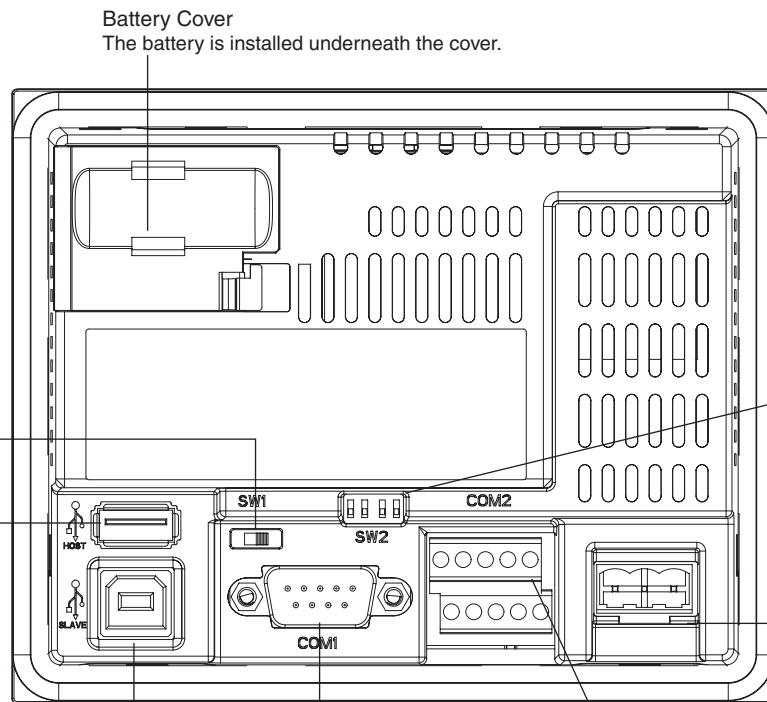

Battery Cover
The battery is installed underneath the cover.

Slide Switch SW1
Used to start the System Menu.

USB Host Connector
It is a USB Type A connector.

USB Slave Connector
This is a USB Type B connector.

Serial Port COM1 Connector
Uses an RS-232C 9-pin connector.

Serial Port COM2 Connector
Uses an RS-422A/485 terminal block.

DIP Switch SW2
Used to switch to RS-422A/485 and set terminating resistance.

DC Input Terminals
Used to connect the 24 VDC power supply.

Precautions for Safe Use

Confirm system safety before turning the power ON/OFF.

NP3-MQ001B/MQ001

Front Panel

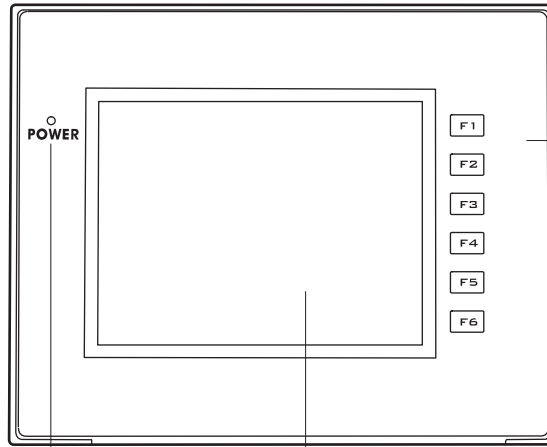

Function Switch.
Used for input.

POWER Indicator
The light turns ON/OFF to indicate the ON/OFF condition of the power.

Display
3.8-inch STN high luminance LCD
The entire display is a touch panel that serves as an input device.

Rear Panel

Battery Cover
The battery is installed underneath the cover.

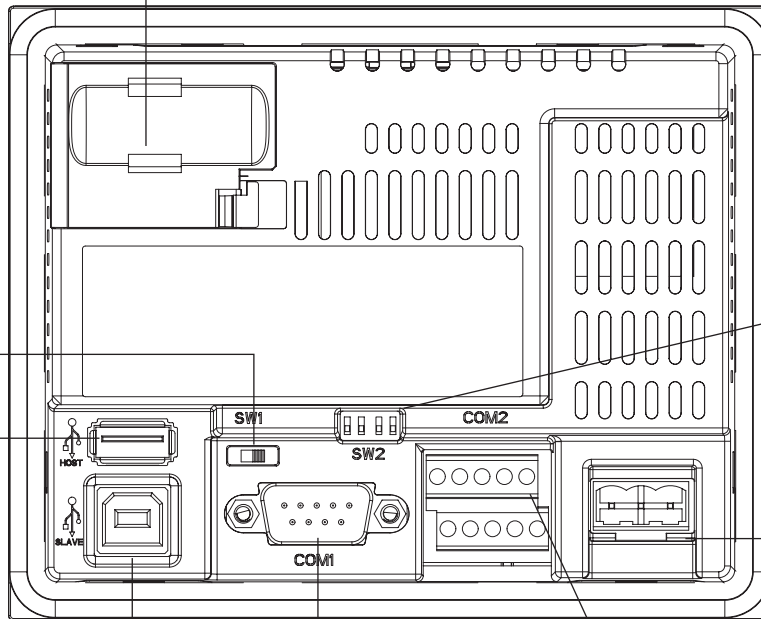

Slide Switch SW1
Used to start the System Menu.

USB Host Connector
It is a USB Type A connector.

USB Slave Connector
This is a USB Type B connector.

Serial Port COM1 Connector
Uses an RS-232C 9-pin connector.

Serial Port COM2 Connector
Uses an RS-422A/485 terminal block.

DIP Switch SW2
Used to switch to RS-422A/485 and set terminating resistance.

DC Input Terminals
Used to connect the 24 VDC power supply.



Precautions for Safe Use

Confirm system safety before turning the power ON/OFF.

2-2 Specifications

Touch Panel

The touch switches on the front panel of the PT are used to perform input operations. Press the touch switches to perform operations such as switching screens and sending bit status to the host.

 WARNING	
Do not use the PT touch switch input functions for applications where danger to human life or serious property damage is possible, or for emergency switch applications.	
Do not press two or more touch switches at the same time. If doing so, other switch between these switches may be operated.	

Precautions for Safe Use

- Do not exceed a pressure of 30 N when pressing any of the touch switches.
- Do not press the touch switches when the backlight is not lit or when there is no display.
- Check system safety before pressing the touch switches.
- Do not use the touch switches with tools such as screwdriver.
- Inputs may not be recognized if the touch switches are pressed in rapid succession. Check that one input operation has finished before performing the next one.
- Touch panel resistance may change over time, causing the touch points to shift. Periodically perform the calibration.

Connector Pin Arrangement of COM1

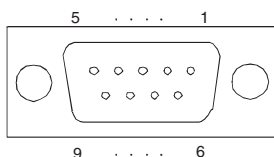

Pin number	Signal name	Name
1	NC	Not connected.
2	SD	Send data
3	RD	Receive data
4	RS	Request to send
5	CS	Clear to send
6	5VDC	5VDC output (250 mA max.)
7	NC	Not connected.
8	NC	Not connected.
9	SG	Signal ground

Precautions for Safe Use

Make sure that the total current capacity of devices being supplied power is 250 mA maximum before using the 5VDC power supply from pin 6. The capacity of the PT's 5VDC output is 250 mA maximum at 5VDC \pm 5%.

Connector Pin Arrangement of COM2

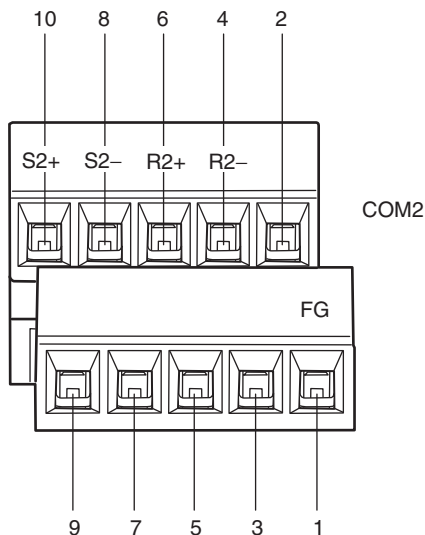

Pin number	Signal name	Name
1	FG	Functional ground
2	SG	Signal ground
3		Not Connected
4	RDA(-)	Receive data
5		Not Connected
6	RDB(+)	Receive data
7		Not Connected
8	SDA(-)	Send data
9		Not Connected
10	SDB(+)	Send data

Slide Switch SW1



The system menu will be displayed when setting the slide switch to the left (ON) to turn ON the power. With the slide switch in the left position, user screens cannot be displayed. Therefore, the slide switch must always be in the right position (OFF).

DIP Switch SW2

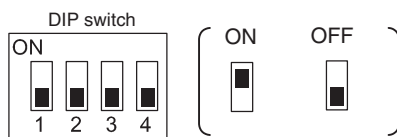

Pin No.	Function	ON	OFF
Pin 1	COM2 RS422A/485 setting	RS-485	RS-422A
Pin 2	COM2 RS-422A/485 setting	RS-485	RS-422A
Pin 3	COM2 terminating resistance setting	Terminating resistance enabled	Terminating resistance disabled
Pin 4	Not used	---	---

Set the RS-422A/RS-485 of the COM2 serial port and the terminating resistance. When using RS-422A, set pin 1 and 2 to OFF. When using RS-485, set pin 1 and 2 to ON.

When connecting to the host using RS-422A/485, set pin 3 to ON (enable the terminating resistance) of the PT connected at the end. Also when using a 1:1 connection, set pin 3 to ON (enable the terminating resistance).

SECTION 3



Installing the PT and Connecting Peripheral Devices

This section describes the methods used to install the PT and connect peripheral devices.

3-1	Installing the PT	18
3-1-1	Installation Environment	18
3-1-2	Mounting the PT to the Control Panel	19
3-1-3	Connecting the Power Supply	20
3-1-4	Wiring the Ground Wire.	20
3-2	Starting the PT	21
3-3	Connecting the NP-Designer	22
3-3-1	Connecting via RS-232C	22
3-3-2	Connecting via USB.	22
3-4	Connecting with a 1:1 NT Link	24
3-4-1	Connection Methods	24
3-4-2	Unit Setting Methods	26
3-5	Connecting with 1:N NT Links	29
3-5-1	Connection Methods	29
3-5-2	Unit Setting Methods	30
3-6	High-speed 1:N NT Links	37
3-6-1	Unit Setting Methods	37
3-7	Host Link	43
3-7-1	Connection Methods	43
3-7-2	Unit Setting Methods	44
3-8	Connecting to Temperature Controllers	59
3-8-1	Overview	59
3-8-2	Wiring	59
3-8-3	Communications Settings	59
3-9	Using USB Flash Memory	60
3-9-1	Transferring Data with USB Flash Memory	60

3-1 Installing the PT

The methods used to mount the PT to the control panel and connect the power supply are described here.

 WARNING	
After the NP-series PT has been installed, qualified personnel must confirm the installation, and must conduct test operations and maintenance. The qualified personnel must be qualified and authorized to secure safety at each phases of design, installation, running, maintenance, and disposal of system.	
A qualified person in charge, who is familiar with the machine, must conduct and verify the installation of the NP-series PT.	

3-1-1 Installation Environment

Always mount the PT to the control panel and perform other installation procedures according to the following precautions.

Precautions for Correct Use

Do not install the PT in any of the following locations:

- Locations subject to extreme temperature changes.
- Locations subject to temperatures or humidity outside the ranges in the specifications.
- Locations subject to high humidity that may result in condensation.
- Locations that would subject the PT to chemicals.
- Locations that would subject the PT to oil.
- Locations subject to corrosive or flammable gases.
- Locations that would subject the PT to direct shock or vibration.
- Locations that would directly expose the PT to wind or rain.
- Locations subject to strong ultraviolet light.

Provide proper shielding measures when installing in the following locations:

- Locations subject to static electricity or other sources of noise.
- Locations subject to strong electromagnetic fields.
- Locations near power supply lines.
- Locations subject to possible exposure to radiation.

Precautions for Safe Use

When unpacking the PT and peripheral devices, check for any external damage. Shake the product gently and check for any abnormal sounds.

3-1-2 Mounting the PT to the Control Panel

The PT is flush-mounted to the control panel.

The PT is mounted using the panel mounting brackets provided with the PT, and tools, such as a Phillips screwdriver.

Use the following procedure to mount the PT to the control panel.

- 1,2,3... 1. Make a hole in the panel for flush mounting according to the following dimensions and insert the PT from the front of the panel.

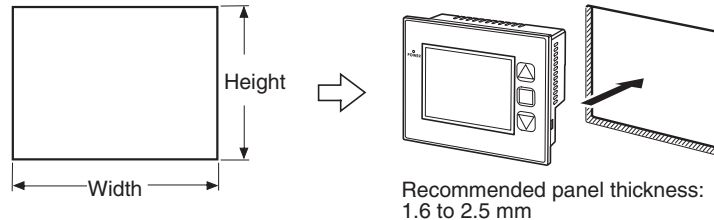

Model	Dimensions
NP5	Width 172.4 ⁺¹ ₀ × Height 132.4 ⁺¹ ₀ mm
NP3	Width 118.5 ⁺¹ ₀ × Height 92.5 ⁺¹ ₀ mm

2. Secure the panel mounting brackets from the back of the panel, as shown in the following diagram.

Insert the catch on each bracket into the square hole on the PT, and secure the PT to the panel by tightening the screws with a Phillips screwdriver while gently pulling in the PT.

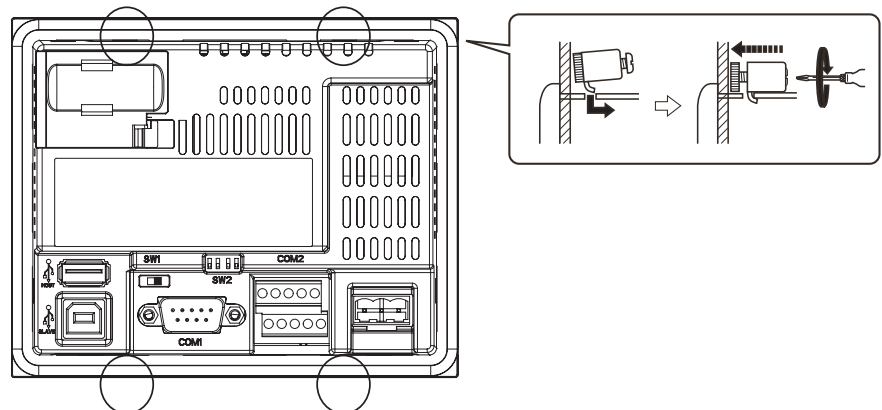

Precautions for Safe Use

- Always install the PT in the control panel.
- Do not allow metal particles to enter the PT while work is being performed on the panel.
- The allowable thickness of the panel for mounting is between 1.6 and 2.5 mm.
Secure the mounting brackets with a uniform tightening torque of between 0.7 N·m to keep the PT waterproof and dustproof. The front sheet may become distorted if the tightening torque is more than the specified limit or not uniform. Always use a panel that is clean, not distorted, and strong enough to adequately withstand mounting the PT.

3-1-3 Connecting the Power Supply

Connect a 24-VDC power supply to the power input terminals.

Precautions for Safe Use

- Do not connect an AC power supply to the DC power terminals.
- Use a DC power supply with low voltage fluctuation.
- Do not perform a dielectric strength test.
- Use a DC power supply that will provide a stable output even if the input is momentarily interrupted for 10 ms, and which has reinforced or double insulation.

■ **Power Supply**

The following table shows the specifications for the power supply that can be connected. Determine power supply specifications that meet the power supply capacity requirements.

Item	Value
Power supply voltage	24 VDC
Allowable voltage range	21.6 to 27.6 VDC (24 VDC -10% to +15%)
Power supply capacity	12 W minimum

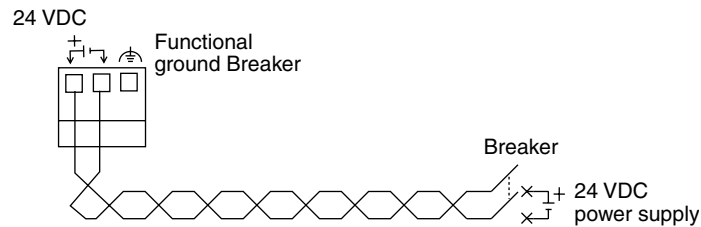

Precautions for Safe Use

- Connect power to the power connector using twisted-pair power lines with a cross-sectional area of at least 2 mm² (AWG14).
- The tightening torque of the terminal block is 0.51 N·m.

3-1-4 Wiring the Ground Wire

The PT is provided with a functional ground (FG: \oplus) terminal.

Wire the FG terminal according to the following conditions.

- 1,2,3...
1. Ground according to *Figure* when there is difference in potential between the PT and host. Do not ground the functional ground (FG: \oplus) of the PT if it is far from the host and one-point grounding is difficult.
 2. Do not ground the functional ground (FG: \oplus) of the PT if it is mounted to the same panel as devices that generate noise, such as motors and inverters.

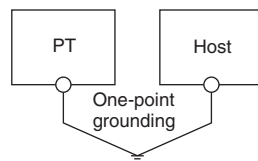

Precautions for Safe Use

Ground correctly to prevent malfunctions caused by noise.

3-2 Starting the PT

Check that the hardware is connected properly, turn ON the power to the PT, and then start the PT.

Use the following procedure to start the PT.

Starting the PT For the First Time

- 1,2,3...**
1. Make sure that SW1 (slide switch) on the back is set to the right (OFF).
 2. Turn ON the power to the PT. The indicator on the front will light and the PT is started.
 3. The series name, date and time are shown on the display. Confirm whether the date and time are correct.
 4. Set the date and time in the system menu. To start the system menu, turn OFF the power, set the slide switch SW1 to the left (ON) and then turn ON the power again.

Starting the PT to Which Screen Data Were Downloaded

- 1,2,3...**
1. Make sure that SW1 (slide switch) on the back is set to the right (OFF).
 2. Turn ON the power to the PT. The indicator on the front will light and the PT is started.
 3. The initial screen of the downloaded screen data is shown on the display.

Starting the System Menu

- 1,2,3...**
1. Set the SW1 (slide switch) on the back to the left (ON).
 2. Turn ON the power to the PT. The indicator on the front will light and the PT is started.
 3. The system menu is shown on the display.

**Precautions
for Safe Use**

Confirm system safety before turning the power ON and OFF.

3-3 Connecting the NP-Designer

Use an RS-232C or USB cable to connect the PT and computer to transfer screen data created with the NP-Designer to the PT.

3-3-1 Connecting via RS-232C

Connect the RS-232C cable from the computer to COM1 serial port.

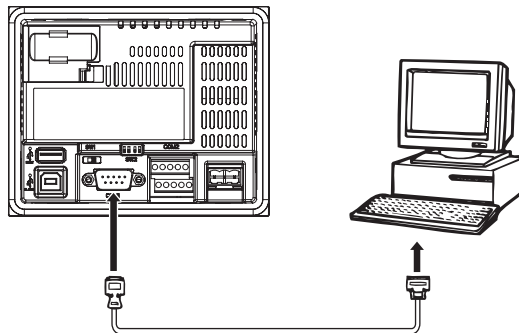

Communications Conditions

The communications conditions are set from the **PT** Menu of the NP-Designer. For details, refer to *6-2-4 PT Menu*.

Recommended Connecting Cables

The following cables are recommended when connecting via RS-232C.

XW2Z-S002 (OMRON, cable length: 2 m)

(D-Sub male 9-pin and D-Sub female 9-pin, for IBM PC/AT or compatible computers)

For details on preparing connecting cables, refer to *Appendix D Preparing Connecting Cables*.

3-3-2 Connecting via USB

Connect the USB port on the computer to the USB slave connector on the PT. Some preparations are required and some restrictions exist, as described below. Be sure to connect USB correctly.

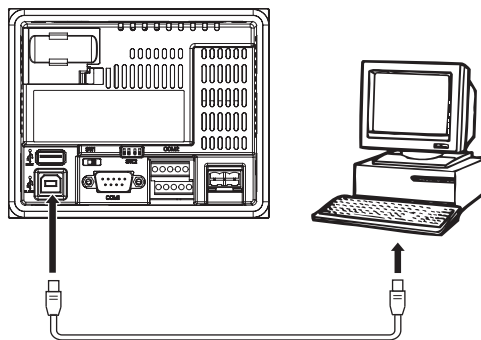

USB Driver for PTs

To transfer screens using USB communications, a USB driver for the PT must be installed in the computer. The USB driver is automatically installed when the computer is connected to the PT for the first time.

**Precautions
for Safe Use**

- Commercially available and recommended USB Hubs do not have the same specifications as the NP-series PT. Normal operation may not be possible in environments subject to noise or static electricity. When using USB Hubs, be sure to provide sufficient measures to prevent noise and static electricity, or install in a location that is not subject to noise or static electricity.
- Do not connect the USB connector to any device that is not applicable.
- Before connecting the USB connector to a device, make sure that the device is free of damage.

All models in the NP Series support USB communications. Use a commercially available USB cable to connect the PT to the USB port.

Use a USB cable that is 5 m or shorter.

3-4 Connecting with a 1:1 NT Link

3-4-1 Connection Methods

This section describes the methods for connecting the host to a serial port of the PT using RS-232C, RS-422A or RS-485 communications. The connection methods are as follows:

Direct Connection to the COM 1 Serial Port Using RS-232C

This is the easiest connection method. OMRON cables with connectors can be used, depending on the host being connected.

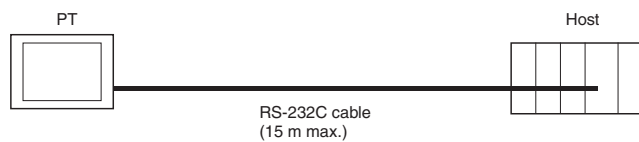

Connection to COM2 Serial Port using RS-422A/485

This connection method allows an extended communications distance of up to 500 m.

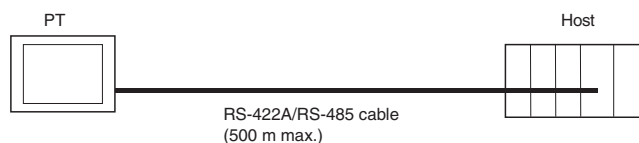

Using RS-232C and RS-422A or RS-232C and RS-485 allows connecting two hosts at the same time. Any combination of devices can be connected to the PT.

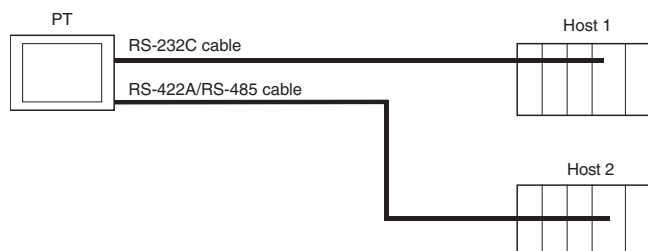

To use the COM2 serial port, the SW2 DIP switch on the back of the PT must be set.

Pin No.	Function	ON	OFF
Pin 1	COM2 RS-422A/485 setting	RS-485	RS-422A
Pin 2	COM2 RS-422A/485 setting	RS-485	RS-422A
Pin 3	COM2 terminating resistance setting	Terminating resistance enabled	Terminating resistance disabled
Pin 4	Not used	---	---

Precautions for Safe Use

- Always tighten the connector screws after connecting communications cables. The tightening torque of the serial port COM2 is 0.2 N·m.
- The connector's pull load is 30 N.
Do not subject the connectors to a greater load than that specified.

Supported Host Units

Some models and series of OMRON PLCs have a built-in 1:1 NT Link function.

Some PLCs can also be connected in a 1:1 NT Link by adding a Serial Communications Board or Communications Board.

When connecting the PT to a PLC, check the series and model of the PLC and the model of the Board mounted to the PLC.

Refer to *Appendix E Standard Models* for details on the Units that can be connected to NP-series PTs as hosts using RS-232C, RS-422A or RS-485 communications in a 1:1 NT Link.

Precautions for Correct Use

CS/CJ series CPU Units cannot be connected in a 1:1 NT Link. Use a 1:1 connection through 1:N NT Links (normal or high speed). For details, refer to *3-5 Connecting with 1:N NT Links* or *3-6 High-speed 1:N NT Links*.

Connecting to CPM2C PLCs

The CPM2C has a single connector that is the same shape as a CS-series peripheral port. Internally, the connector has signal lines that are for use with the CPU's built-in RS-232C port and the peripheral port. Therefore, when using the CPM2C, use the settings for the CPU's built-in RS-232C port or for the peripheral port according to the converter cable and port used. When using a CPM2C1-CIF21 Simplified Communications Unit, connect it to the RS-232C port.

Refer to the *CPM2C Operation Manual (W356)* for details.

Use CS1W-CN118 Connecting Cable to connect the CPM2C to the NP-series PT using the built-in RS-232C port of the CPM2C. The peripheral port cannot be used to connect the PT.

Port for connecting PT	PLC Setup
CS1W-CN118 port (D-Sub 9-pin)	Set for built-in RS-232C.

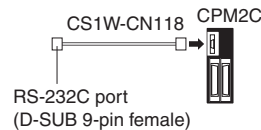

When using a CPM2C1-CIF21 Simplified Communications Unit, connect it to the RS-232C port.

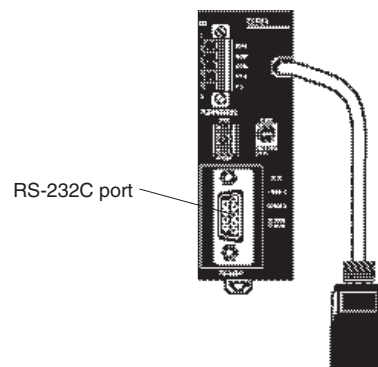

3-4-2 Unit Setting Methods

The methods for setting each Unit are as follows:

Connecting C Series, C200HX/HG/HE(-Z), CQM1, CPM2A, CPM2C or CQM1H PLCs

PLC Setup Area

Write the settings directly from the Programming Device (CX-Programmer, etc.) to the PLC Setup Area (in DM Area) according to the host type and port used.

Using RS-232C

Host type	Address	Write value	Settings
Built-in RS-232C port of C200HX/HG/HE(-Z), CPM2A, CPM2C, CQM1, or CQM1H	DM 6645	4000	Uses 1:1 NT Link
CPM1A	DM 6650		
Port A of C200HX/HG/HE(-Z) (See note 1.) Port 1 of CQM1H (See note 2.)	DM 6555		
Port B of C200HX/HG/HE(-Z) (See note 1.)	DM 6550		

- Note**
- (1) RS-232C port of Communications Board.
 - (2) RS-232C port of Serial Communications Board.

Using RS-422A/485

Host type	Address	Write value	Settings
Port A of C200HX/HG/HE(-Z) (See note 1.)	DM 6555	4000	Uses 1:1 NT Link
Port 2 of CQM1H (See note 2.)	DM 6550		

- Note**
- (1) RS-422A/485 port of Communications Board.
 - (2) RS-422A/485 port of Serial Communications Board.

Refer to the manuals of the PLC being used for details on using the PLC Setup Area.

Setting the Front Panel DIP Switch

Set the DIP switch on the front panel to enable the PLC Setup Area (Data Memory) settings, as follows:

Using the C200HX/HG/HE(-Z), CQM1, or CQM1H PLCs via RS-232C

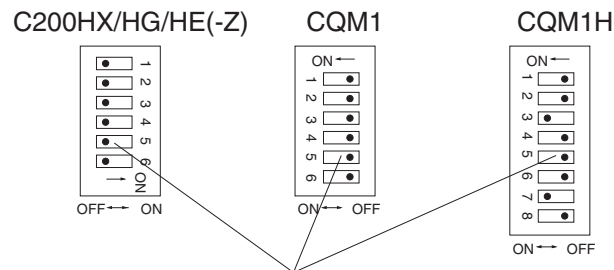

RS-232C Communications Conditions Setting
Set pin 5 of the DIP switch to OFF to enable the PLC Setup Area settings.

Using the CPM2A

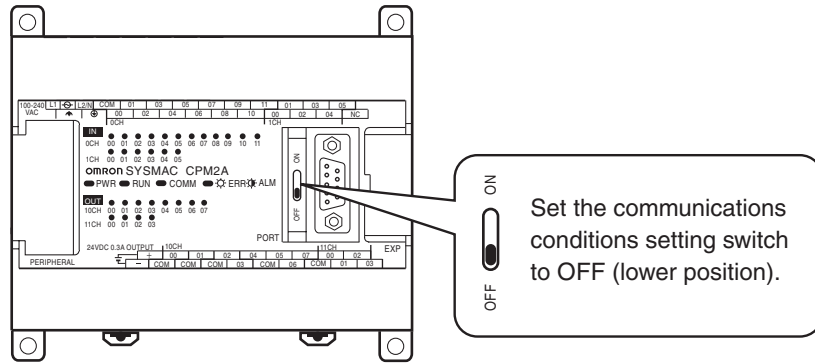

Using the CPM2C (via RS-232C only)

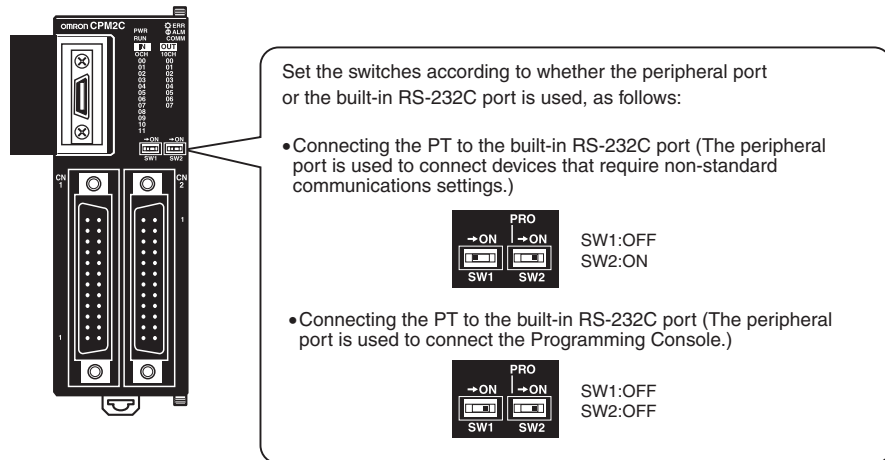

Setting the Communications Board Switches (Using RS-422A/485)

Using the C200HX/HG/HE(-Z)

Switch 1: 4 (Four-wire method = RS-422A),

2 (Two-wire method = RS-485)

Switch 2: ON (terminator ON = terminating resistance used)

Using the CQM1H

Two-wire/four-wire switch (WIRE): 4 (Four-wire method = RS-422A),

2 (Two-wire method = RS-485)

Terminating resistance switch (TERM): ON (terminator ON = terminating resistance used)

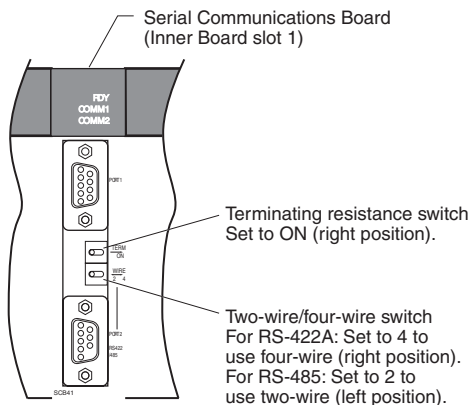

Connecting to CVM1/CV Series (-V) PLCs

PLC Setup

When using CVM1/CV-series PLCs, always set the Execute Process (Execute Control 2) in the PLC Setup to **synchronous** execution.

Setting the Front Panel DIP Switch

Set the DIP switch as follows. When connecting to RS-485, set the switch to RS-422A.

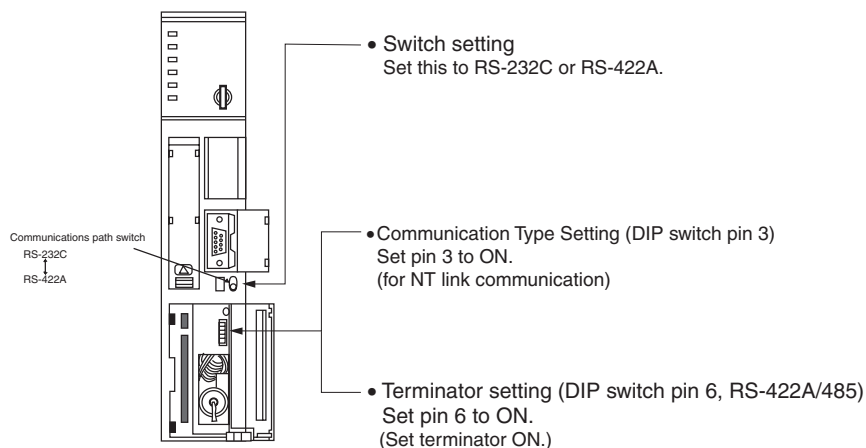

3-5 Connecting with 1:N NT Links

3-5-1 Connection Methods

This section describes the methods used to connect NP-series PTs using the 1:N NT Link protocol.

The COM2 serial port of the PT is used. This connection method can be used for 1:N NT Link connections (normal, high-speed).

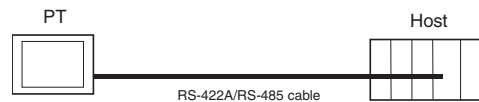

Supported Host Units

The OMRON PLCs that can be connected in 1:N NT Links are limited to the CS-series, CJ-series, CP-series, and C-series PLCs. CS-series PLCs can also be connected in 1:N NT Links by using a CS1W-SCU21 Serial Communications Unit. CJ-series PLCs can also be connected in 1:N NT Links by using a CJ1W-SCU41 Serial Communications Unit.

Check the series and model of the PLC and the model of the Board or Unit that is mounted to the PLC when connecting the PTs to the host.

For details on the Units used as hosts that can be connected in 1:N NT Links, refer to *Appendix E Standard Models*.

To use the COM2 serial port, the SW2 DIP switch on the back of the PT must be set.

Pin No.	Function	ON	OFF
Pin 1	COM2 RS-422A/485 setting	RS-485	RS-422A
Pin 2	COM2 RS-422A/485 setting	RS-485	RS-422A
Pin 3	COM2 terminating resistance setting	Terminating resistance enabled	Terminating resistance disabled
Pin 4	Not used	---	---

Reference CS-series PLCs with -V1 suffix support high-speed 1:N NT Links as well as normal 1:N NT Links. CS-series PLCs without the -V1 suffix can also be connected to high-speed 1:N NT Links if the latest Serial Communications Board/Unit is used. Refer to *3-6 High-speed 1:N NT Links* for details.

3-5-2 Unit Setting Methods

The methods for setting each unit are as follows:

Connecting to CP-series PLCs

CP1L-□-□ and CP1H-□-□

PLC Setup Area

Write the settings directly from the Programming Device or Support Software (CX-Programmer, etc.) to the PLC Setup Area according to the host type and port used.

Host type	Address	Write value	Settings
CP1L-M CP1H	144	8200	Uses 1:N NT Link
	145	0000	Baud rate (normal) 38400bps
	150	000□	□: Largest unit number (0 to 7) of connected PTs. (See note.)
CP1L-L	160	8200	Uses 1:N NT Link
	161	0000	Baud rate (normal) 38400bps
	166	000□	□: Largest unit number (0 to 7) of connected PTs. (See note.)

Note When connecting a PROCOM, always set the value for □ to 0.

Setting the Front Panel Switches

Set the DIP switch on the front panel to enable the PLC Setup Area settings, as follows:

When using the serial port 1, set SW4 to OFF. When using the serial port 2, set SW5 to OFF. CP1L-L has only one serial port. Therefore there is no DIP switch SW5.

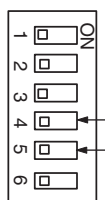

CP1L-M
CP1H

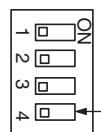

CP1L-L

Connecting to C-series C200HX/HG/HE(-Z), and CQM1H PLCs

PLC Setup Area

Write the settings directly from the Programming Device or Support Software (CX-Programmer, etc.) to the PLC Setup Area (Data Memory) according to the host type and port used.

Using RS-232C

Host type	Address	Write value	Settings
Built-in RS-232C port of C200HX/HG/HE(-Z)	DM 6645	5□00	Uses 1:N NT Link □: Largest unit number (0 to 7) of connected PTs. (See note 3.)
Port A of C200HX/HG/HE(-Z) (See note 1.)	DM 6555		
Port 1 of CQM1H (See note 2.)			
Port B of C200HX/HG/HE(-Z) (See note 1.)	DM 6550		

Note

- (1) RS-232C port of Communications Board.
- (2) RS-232C port of Serial Communications Board.
- (3) The PT unit numbers for the C200HE (-Z) are 0 to 3.

Using RS-422A/485

Host type	Address	Write value	Settings
Port A of C200HX/HG/HE(-Z) (See note 1.)	DM 6555	5□00	Uses 1:N NT Link
Port 2 of CQM1H (See note 2.)	DM 6550	5□00	□: Largest unit number (0 to 7) of the con- nected PTs. (See note 3.)

- Note**
- (1) RS-422A/485 port of Communications Board.
 - (2) RS-422A/485 port of Serial Communications Board.
 - (3) The PT unit numbers for the C200HE (-Z) are 0 to 3.

Refer to the manuals of the PLC being used for details on using the PLC Setup Area.

Precautions for Correct Use

- There is no Communications Board for use with C200HX/HG/HE (-Z) where port B is an RS-422A/485 port.
- There is no Communications Board for use with CQM1H where Port 1 is an RS-422A/485 port.
- When setting a 1:N NT Link in the CX-Programmer, set the baud rate to 38,400 bps.

Setting the Front Panel DIP Switch (Using RS-232C)

When using C200HX/HG/HE(-Z), set the DIP switch on the front panel to enable the PLC Setup Area (Data Memory) settings, as follows:

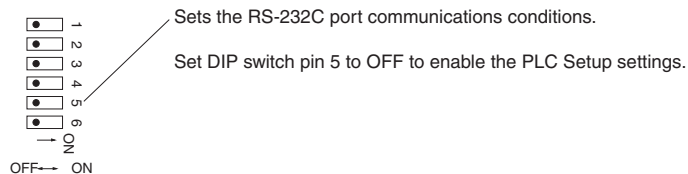

Setting the Communications Board Switches (Using RS-422A/485)

Using C200HX/HG/HE(-Z)

Switch 1: 4 (Four-wire method = RS-422A)

2 (Two-wire method = RS-485)

Switch 2: ON (terminator ON = terminating resistance used)

Using CQM1H

Two-wire/four-wire switch (WIRE): 4 (Four-wire method = RS-422A)

2 (Two-wire method = RS-485)

Terminating resistance switch (TERM): ON (terminator ON = terminating resistance used)

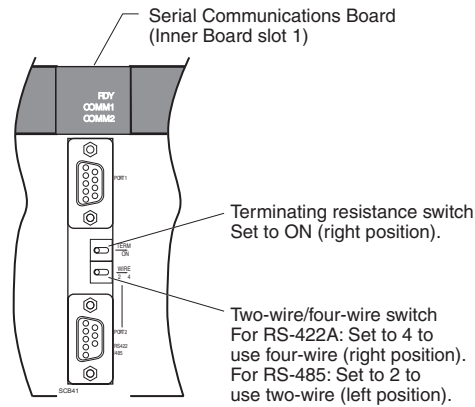

Connecting to CS-series CPU Units

CS1G/H-CPU□□-E(V1) and CS1G/H-CPU□□H

PLC Setup Area

Using RS-232C

When connecting the PT to a CS-series CPU Unit, set the communications conditions in the PLC Setup according to the communications port used, as follows:

Using Built-in RS-232C Port of CS1G/H or CS1G/H-H

Address	Write value	Settings
160	8200	1:N NT Link Mode
161	0000 to 0009 (See note 1.)	Baud rate (normal)
166	000□	□: Largest unit number (0 to 7) of the connected PTs.

Note (1) Set the baud rate to a numeric value between 0000 to 0009 Hex. (The setting is the same for any value between 0000 and 0009 Hex.)

For example, to connect PTs with unit numbers 0, and 2 to 5 to the built-in RS-232C port in 1:N NT Links, set address 160 to 8200 Hex, and address 166 to 0005 Hex.

Set whether the PLC Setup is set directly from the Programming Device (Programming Console) or created using the Support Software (CX-Programmer) and transferred to the CPU Unit.

Refer to the *SYSMAC CS Series Operation Manual (W339)* for information on PLC Setup.

Precautions for Correct Use

When setting a 1:N NT Link in the CX-Programmer, set the baud rate to 38,400 bps.

Setting the Front Panel Switches

Using RS-232C

Set DIP switch pin 4 or 5 of the CPU Unit according to the port to which the PT is connected, as follows:

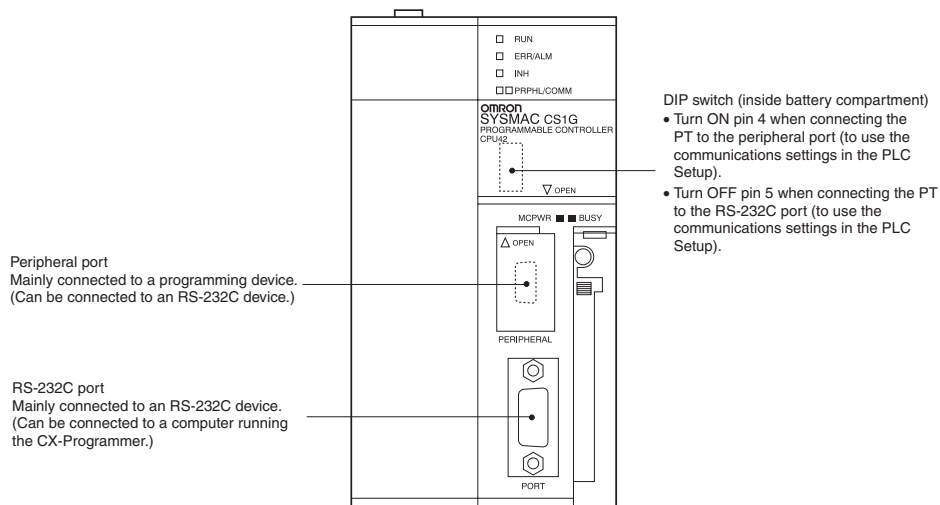

Connecting to CJ-series CPU Units

CJ1G-CPU□□

PLC Setup Area

Using RS-232C

When connecting the PT to a CJ-series CPU Unit, set the communications conditions in the PLC Setup according to the communications port used, as follows:

Using the CJ1G/H-H, CJ1G, or CJ1M Built-in RS-232C Port

Address	Write value	Settings
160	8200	1:N NT Link Mode
161	0000 to 0009 (See note 1.)	Baud rate (normal)
166	00□	□: Largest unit number (0 to 7) of the connected PTs.

Note (1) Set the baud rate to a numeric value between 0000 to 0009 Hex. (The setting is the same for any value between 0000 and 0009 Hex.)

For example, to connect PTs with unit numbers 0, and 2 to 5 to the built-in RS-232C port in 1:N NT Links, set address 160 to 8200 Hex, and address 166 to 0005 Hex.

Set whether the PLC Setup is set directly from the Programming Device (Programming Console) or created by the Support Software (CX-Programmer) and transferred to the CPU Unit.

Refer to the *SYSMAC CJ Series Operation Manual (W393)* for information on the PLC Setup.

Precautions for Correct Use

When setting a 1:N NT Link in the CX-Programmer, set the baud rate to 38,400 bps.

Setting the Front Panel Switches

Using RS-232C

Set DIP switch pin 4 or 5 of the CPU Unit according to the port to which the PT is connected, as follows:

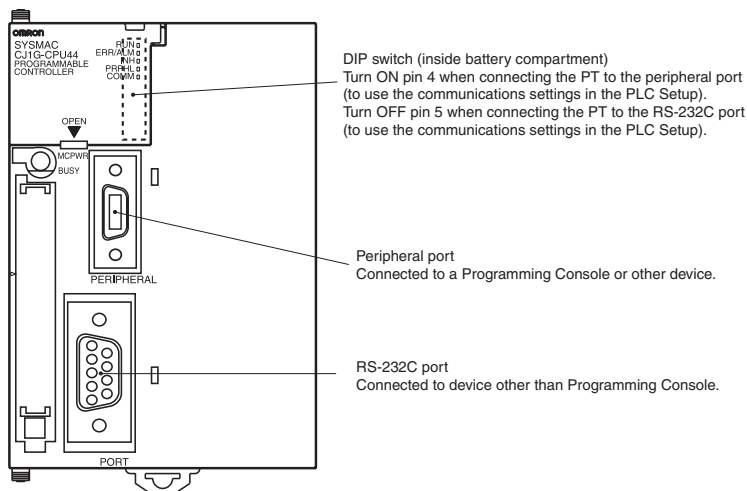

Connecting to CS-series Serial Communications Boards

Serial Communications Boards with RS-232C and RS-422A/485 Ports for Use with CS-series CPU Units:

CS1W-SCB21 (Both ports 1 and 2 are RS-232C ports.)

CS1W-SCB41 (Port 1 is an RS-232C port and Port 2 is an RS-422A/485 port.)

Setting DM Area Allocations in CPU Unit

Write the settings directly from the Programming Device or Support Software (Programming Console or CX-Programmer) to the DM Area (Parameter Area) in the CPU Unit. After writing the settings, enable the settings by turning ON the power again, restarting the Unit, restarting the communications port, or executing the CHANGE SERIAL PORT SETUP (STUP) instruction.

The following table shows the allocated DM Area words and settings.

The allocations and settings are the same for RS-232C and RS-422A/485 (CS1W-SCB41 Port 2).

Allocated DM Area words		Write value	Settings
Port 1	Port 2		
DM32000	DM32010	8200	1:N NT Link Mode
DM32001	DM32011	0000 to 0009 (See note 1.)	Baud rate (normal)
DM32006	DM32016	000□	□: Largest unit number (0 to 7) of the connected PTs.

Note (1) Set the baud rate to a numeric value between 0000 to 0009 Hex. (The setting is the same for any value between 0000 and 0009 Hex.)

For example, to connect PTs with unit numbers 3 to 6 to Port 1 in 1:N NT Links, set DM32000 to 8200 Hex, DM32001 to 0000 Hex, and DM32006 to 0006 Hex.

Precautions for Correct Use

When setting a 1:N NT Links in the CX-Programmer, set the baud rate to 38,400 bps

Setting the Front Panel Switches

Using RS-422A/485

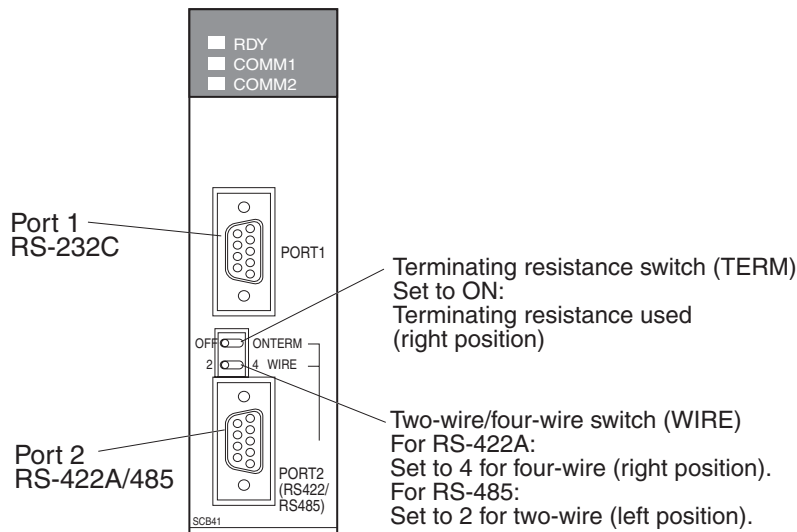

Connecting to CS-series Serial Communications Units

CS1W-SCU21 (Both ports 1 and 2 are RS-232C ports.)

CPU Unit DM Area Settings

Using RS-232C

Write the settings directly from the Programming Device or Support Software (Programming Console or CX-Programmer) to the DM Area (Parameter Area) in the CPU Unit. After writing the settings, enable the settings by turning ON the power again, restarting the Unit, restarting the communications port, or executing the CHANGE SERIAL PORT SETUP (STUP) instruction.

The following table shows the allocated DM Area words and settings.

$$m = 30000 + 100 \times \text{unit number}$$

Allocated DM Area words		Write value	Settings
Port 1	Port 2		
DM m	DM m+10	8200	1:N NT Link Mode
DM m+1	DM m+11	0000 to 0009 (See note 1.)	Baud rate (normal)
DM m+6	DM m+16	000□	□: Largest unit number (0 to 7) of the connected PTs.

Note (1) Set the baud rate to a numeric value between 0000 to 0009 Hex. (The setting is the same for any value between 0000 and 0009 Hex.)

Precautions for Correct Use

When setting a 1:N NT Links in the CX-Programmer, set the baud rate to 38,400 bps.

Setting the Front Panel Switches

Using RS-232C

Set the unit number of the Serial Communications Unit with the rotary switches on the front of the Unit. Use a flat-blade screwdriver to set the numerals and symbols in the switches setting display window, as follows:

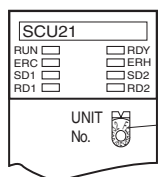

• Unit number setting
Set a value between 0 and F that is not the same as that of other Units.

Connecting to CJ-series Serial Communications Units

CJ1W-SCU41 (Port 1 is an RS-422A/485 port and Port 2 is an RS-232C port.)

CPU Unit DM Area Settings

Write the settings directly from the Programming Device or Support Software (Programming Console or CX-Programmer) to the DM Area (Parameter Area) in the CPU Unit. After writing the settings, enable the settings by turning ON the power again, restarting the Unit, restarting the communications port, or executing the CHANGE SERIAL PORT SETUP (STUP) instruction.

The following table shows the allocated DM Area words and settings.

The allocations and settings are the same for RS-232C, RS-422A and RS-485.

$$m = 30000 + 100 \times \text{unit number}$$

Allocated DM Area words		Write value	Settings
Port 1	Port 2		
DM m	DM m+10	8200	1:N NT Link Mode
DM m+1	DM m+11	0000 to 0009 (See note 1.)	Baud rate (normal)
DM m+6	DM m+16	000□	□: Largest unit number (0 to 7) of the connected PTs.

Note (1) Set the baud rate to a numeric value between 0000 to 0009 Hex. (The setting is the same for any value between 0000 and 0009 Hex.)

Precautions for Correct Use

When setting a 1:N NT Link in the CX-Programmer, set the baud rate to 38,400 bps.

Setting the Front Panel Switches

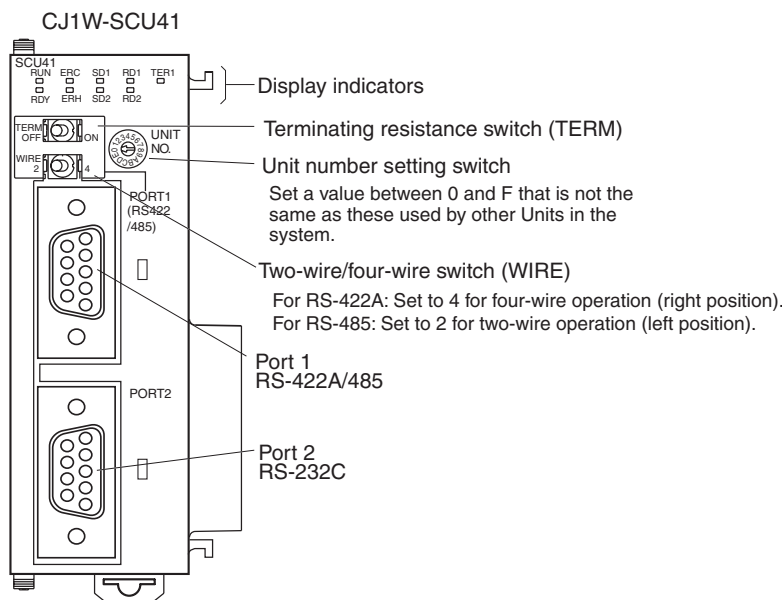

3-6 High-speed 1:N NT Links

Supported Host Units

The OMRON PLCs that can be connected to high-speed 1:N NT Links using RS-232C are as follows:

- CS-series PLCs: CS1G/H-V1 and CS1G/H-H
- CJ-series PLCs: CJ1G, CJ1G/H-H, and CJ1M
- CP-series PLCs: CP1L and CP1H

CS-series PLCs can also be connected in high-speed 1:N NT Links by using a CS1W-SCU21 Serial Communications Unit or CS1W-SCB21/41 Serial Communications Board. (CS-series PLCs without a -V1 suffix can also be connected in high-speed 1:N NT Links if a Serial Communications Unit is used.)

CJ-series PLCs can also be connected in high-speed 1:N NT Links by using a CJ1W-SCU41 Serial Communications Unit.

The OMRON PLCs that can be connected in high-speed 1:N NT Links using RS-422A/485 are as follows:

- CS-series PLCs: CS1G/H and CS1G/H-H
- CJ-series PLCs: CJ1G/H-H, CJ1G, and CJ1M

CS-series PLCs can also be connected in high-speed 1:N NT Links by using a CS1W-SCB41 Serial Communications Board. (CS-series PLCs without -V1 suffix can also be connected in high-speed 1:N NT Links if a Serial Communications Board is used.)

CJ-series PLCs can also be connected in high-speed 1:N NT Links by using a CJ1W-SCU41 Serial Communications Unit.

Check the series and model of the PLC and the model of the Board or Unit that are mounted to the PLC when connecting the PT to the host. For details on the PLCs that can be connected, refer to *Appendix E Standard Models*.

To use the COM2 serial port, the SW2 DIP switch on the back of the PT must be set.

Pin No.	Function	ON	OFF
Pin 1	COM2 RS-422A/485 setting	RS-485	RS-422A
Pin 2	COM2 RS-422A/485 setting	RS-485	RS-422A
Pin 3	COM2 terminating resistance setting	Terminating resistance enabled	Terminating resistance disabled
Pin 4	Not used	---	---

3-6-1 Unit Setting Methods

The methods for setting each Unit are as follows:

Connecting to CP-series PLCs

CP1L-□-□ and CP1H-□-□

PLC Setup Area

Write the settings directly from the Programming Device or Support Software (CX-Programmer, etc.) to the PLC Setup Area according to the host type and port used.

Host type	Address	Write value	Settings
CP1L-M CP1H	144	8200	Uses 1:N NT Link
	145	000A	Baud rate (high-speed) 115,200bps
	150	000□	□: Largest unit number (0 to 7) of connected PTs. (See note.)

Host type	Address	Write value	Settings
CP1L-L	160	8200	Uses 1:N NT Link
	161	000A	Baud rate (high-speed) 115,200bps
	166	000□	□: Largest unit number (0 to 7) of connected PTs. (See note.)

Note When connecting a PROCOM, always set the value for □ to 0.

Setting the Front Panel Switches

Set the DIP switch on the front panel to enable the PLC Setup Area settings, as follows:

When using the serial port 1, set SW4 to OFF. When using the serial port 2, set SW5 to OFF. CP1L-L has only one serial port. Therefore there is no DIP switch SW5.

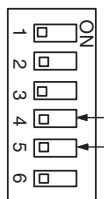

CP1L-M
CP1H

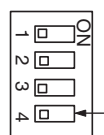

CP1L-L

Connecting to CS-series CPU Units

CS1G/H-CPU□□-EV1/CS1G/H-CPU□□H

PLC Setup Area

Using RS-232C

When connecting the PT to a CS-series CPU Unit, set the communications conditions in the PLC Setup according to the communications port used, as follows:

Using Built-in RS-232C Port of CS1G/H or CS1G/H-H

Address	Write value	Settings
160	8200	1:N NT Link Mode
161	000A	Baud rate (high-speed)
166	000□	□: Largest unit number (0 to 7) of the connected PTs.

For example, to connect PTs with unit numbers 0, and 2 to 5 to the built-in RS-232C port in high-speed 1:N NT Links, set address 160 to 8200 Hex, address 161 to 000A Hex, and address 166 to 0005 Hex.

Set whether the PLC Setup is set directly from the Programming Device (Programming Console) or created by the Support Software (CX-Programmer) and transferred to the CPU Unit.

Refer to the *SYSMAC CS Series Operation Manual (W339)* for information on the PLC Setup.

Precautions for Correct Use

To set high-speed 1:N NT Link communications from the CX-Programmer, set the baud rate to 115,200 bps.

Setting the Front Panel Switches

Using RS-232C

Set DIP switch pin 4 or 5 of the CPU Unit according to the port to which the PT is connected, as follows:

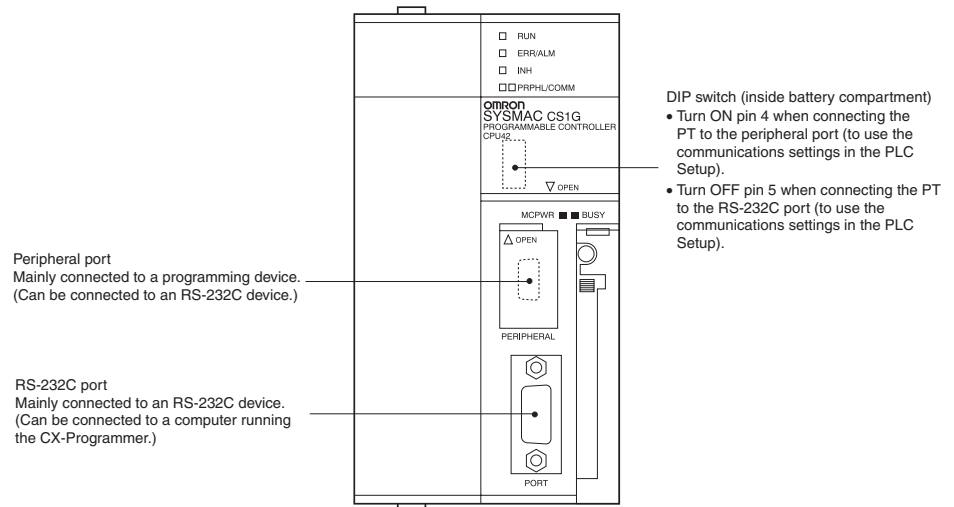

Connecting to CJ-series CPU Units

CJ1G-CPU□□/CJ1G/H-CPU□□-H/CJ1M-CPU□□

PLC Setup Area

Using RS-232C

When connecting the PT to a CJ-series CPU Unit, set the communications conditions in the PLC Setup according to the communications port used, as follows:

Using the CJ1G/H-H, CJ1G, or CJ1M, Built-in RS-232C Port

Address	Write value	Settings
160	8200	1:N NT Link Mode
161	000A	Baud rate (high-speed)
166	000□	□: Largest unit number (0 to 7) of the connected PTs.

For example, to connect PTs with unit numbers 0, and 2 to 5 to the built-in RS-232C port in 1:N NT Links, set address 160 to 8200 Hex and address 166 to 0005 Hex.

Set whether the PLC Setup is to be set directly from the Programming Device (Programming Console) or created by the Support Software (CX-Programmer) and transferred to the CPU Unit.

Refer to the *SYSMAC CJ Series Operation Manual (W393)* for information on the PLC Setup.

Precautions for Correct Use

To set high-speed 1:N NT Link communications from the CX-Programmer, set the baud rate to 115,200 bps.

Setting the Front Panel Switches

Using RS-232C

Set DIP switch pin 4 or 5 of the CPU Unit according to the port to which the PT is connected, as follows:

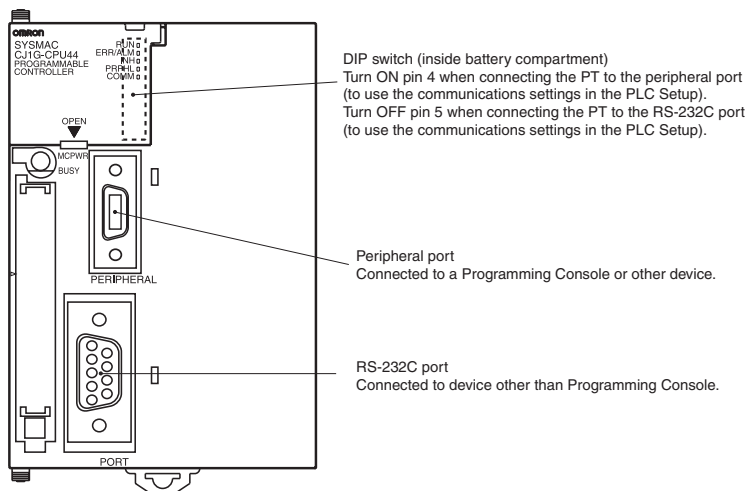

Connecting to CS-series Serial Communications Boards

Serial Communications Boards with RS-232C Port for Use with CS-series CPU Units:

CS1W-SCB21 (Both ports 1 and 2 are RS-232C ports.)

CS1W-SCB41 (Port 1 is an RS-232C port and Port 2 is an RS-422A/485 port.)

Precautions for Correct Use

High-speed 1:N NT Links can be used with Serial Communications Boards and Serial Communications Units from lot numbers 991220 (December 20, 1999) or later. Boards and Units with earlier lot numbers cannot be used, so confirm that the lot number is supported.

CPU Unit DM Area Settings

Write the settings directly from the Programming Device (Programming Console) or Support Software (CX-Programmer) to the DM Area (Parameter Area) in the CPU Unit. After writing the settings, enable the settings by turning ON the power again, restarting the Unit, restarting the communications port, or executing the CHANGE SERIAL PORT SETUP (STUP) instruction.

The following table shows the allocated DM Area words and settings. The settings are the same for RS-232C and RS-422A/485 (CS1W-SCB41 Port 2).

Allocated DM Area words		Write value	Settings
Port 1	Port 2		
DM3200	DM32010	8200	1:N NT Link Mode
DM32001	DM32011	000A	Baud rate (high-speed)
DM32006	DM32016	000□	□: Largest unit number (0 to 7) of the connected PTs.

For example, to connect PTs with unit numbers 3 to 6 to Port 1 in 1:N NT Links, set DM32000 to 8200 Hex, DM32001 to 000A Hex, and DM32006 to 0006 Hex.

Precautions for Correct Use

To set high-speed 1:N NT Link communications from the CX-Programmer, set the baud rate to 115,200 bps.

Setting the Front Panel Switches

Using RS-422A/485

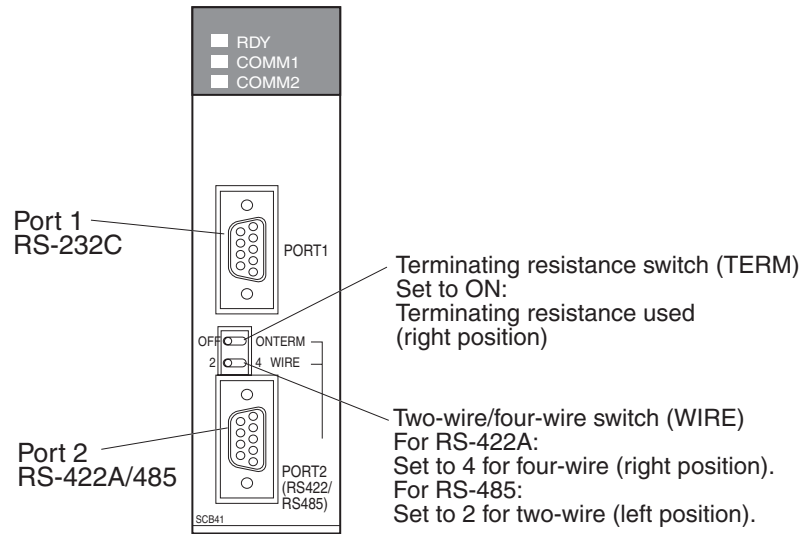

Connecting to CS-series Serial Communications Units

CS-series Rack-mounted Type:
 CS1W-SCU21

Precautions for Correct Use

High-speed 1:N NT Links can be used with Serial Communications Boards and Serial Communications Units from lot numbers 991220 (December 20, 1999) or later. Boards and Units with earlier lot numbers cannot be used, so confirm that the lot number is supported.

CPU Unit DM Area Settings

Write the settings directly from the Programming Device (Programming Console) or Support Software (CX-Programmer) to the DM Area (Parameter Area) in the CPU Unit. After writing the settings, enable the settings by turning ON the power again, restarting the Unit, restarting the communications port, or executing the CHANGE SERIAL PORT SETUP (STUP) instruction.

The following table shows the allocated DM Area words and settings.

Using RS-232C

$$m = 30000 + 100 \times \text{unit number}$$

Allocated DM Area words		Write value	Settings
Port 1	Port 2		
DM m	DM m+10	8200	1:N NT Link Mode
DM m+1	DM m+11	000A	Baud rate (high-speed)
DM m+6	DM m+16	000□	□: Largest unit number (0 to 7) of the connected PTs.

Precautions for Correct Use

To set high-speed 1:N NT Link communications from the CX-Programmer, set the baud rate to 115,200 bps.

Setting the Front Panel Switches

Set the unit number of the Serial Communications Unit with the rotary switches on the front of the Unit. Use a flat-blade screwdriver to set the numerals and symbols of the switch's setting display window, as follows:

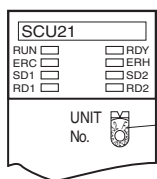

- Unit number setting
Set a value between 0 and F that is not the same as that of other Units.

Connecting to CJ-series Serial Communications Units

CJ1W-SCU41

(Port 1 is an RS-422A/485 port and Port 2 is an RS-232C port.)

CPU Unit DM Area Settings

Write the settings directly from the Programming Device (Programming Console or CX-Programmer) to the DM Area (Parameter Area) in the CPU Unit. After writing the settings, enable the settings by turning ON the power again, restarting the Unit, restarting the communications port, or executing the CHANGE SERIAL PORT SETUP (STUP) instruction.

The following table shows the allocated DM Area words and settings.

The allocations and settings are the same for RS-232C, RS-422A and RS-485.

$$m = 30000 + 100 \times \text{unit number}$$

Allocated DM Area words		Write value	Settings
Port 1	Port 2		
DM m	DM m+10	8200	1:N NT Link Mode
DM m+1	DM m+11	000A	Baud rate (high-speed)
DM m+6	DM m+16	000□	□: Largest unit number (0 to 7) of the connected PTs.

Precautions for Correct Use

To set high-speed 1:N NT Link communications from the CX-Programmer, set the baud rate to 115,200 bps.

Setting the Front Panel Switches

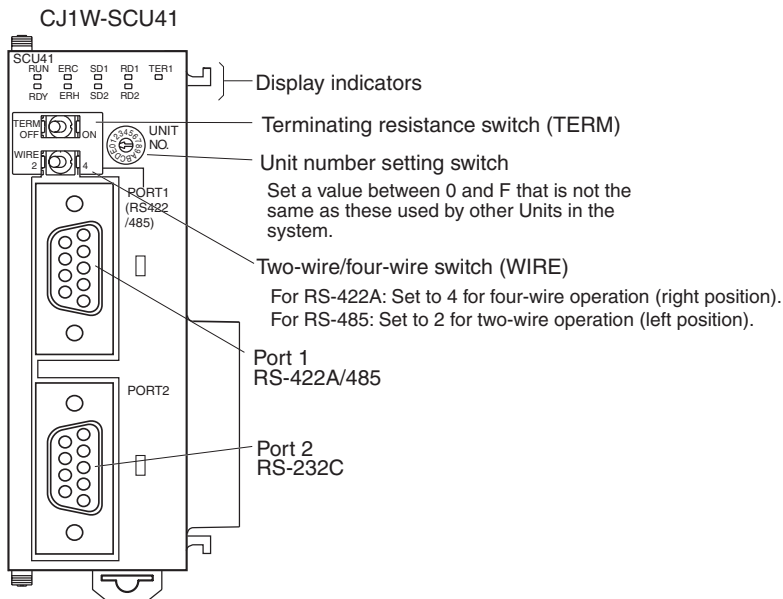

3-7 Host Link

3-7-1 Connection Methods

Host Link is a method used to connect a single PT to a single host in a 1:1 connection in the same way as 1:1 NT Link using RS-232C or RS-422A communications.

Connecting to a COM1 Serial Port Using RS-232C

This is the easiest connection method. OMRON cables with connectors can be used, depending on the host being connected.

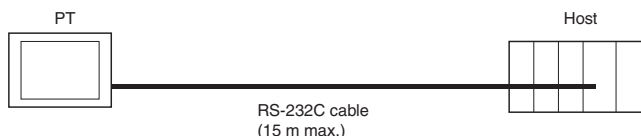

Connecting to a COM2 Serial Port Using RS-422A

This connection method allows an extended communications distance of up to 500 m.

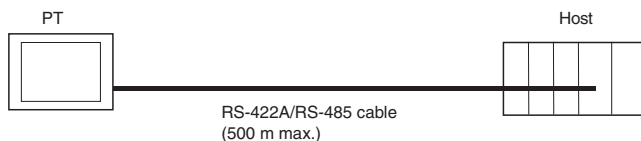

The two hosts can be connected at the same time by using RS-232C and RS-422A. Any combination of devices can be connected to the PT.

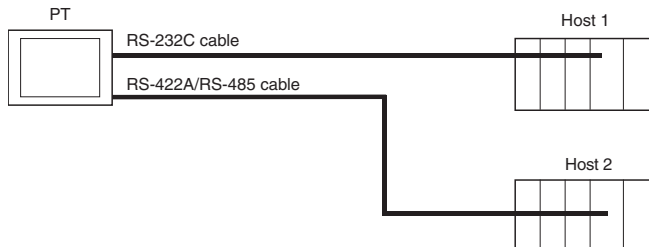

To use the COM2 serial port, the SW2 DIP switch on the back of the PT must be set.

Pin No.	Function	ON	OFF
Pin 1	COM2 RS-422A/485 setting	RS-485	RS-422A
Pin 2	COM2 RS-422A/485 setting	RS-485	RS-422A
Pin 3	COM2 terminating resistance setting	Terminating resistance enabled	Terminating resistance disabled
Pin 4	Not used	---	---

Precautions for Safe Use

- Always tighten the connector screws after connecting communications cables.
- The connector's pull load is 30 N.
Do not subject the connectors to a greater load than that specified.

Supported Host Units

Some models and series of OMRON PLCs have a built-in Host Link function. Some PLCs can also be connected in a Host Link by adding a Serial Communications Board or Communications Board.

When connecting the PT to a PLC, check the series and model of the PLC and the model of the Board mounted to the PLC.

Refer to *Appendix E Standard Models* for details on the Units that can be connected to NP-series PTs as hosts using RS-232C or RS-422A communications in a Host Link.

Communication Settings

This table shows the communication settings required at the PT and host to connect to the host by means of Host Link communications.

Item	Setting
Data Bits	7 bits
Stop Bits	2 bits
Parity	Even
Baud rate	Any value. Note that values set for the PT and host must be the same.
Host Unit No.	0

Use the **PT** Menu from NP-Designer to make these setting of the PT.

Please refer to the *6-2-4 PT Menu* for details.

For communication settings of the host, refer to the relevant manual for each PLC.

3-7-2 Unit Setting Methods

The methods for setting each Unit are as follows:

Connecting to CP-series PLCs

CP1L-□-□ and CP1H-□-□

PLC Setup Area

Write the settings directly from the Programming Device or Support Software (CX-Programmer, etc.) to the PLC Setup Area according to the host type and port used.

Host type	Address	Write value	Settings
CP1L-M CP1H	144	8000	Uses host link
	145	0000 to 000A (See note.)	Baud rate
	150	0000	Unit No. 00
CP1L-L	160	8000	Uses host link
	161	0000 to 000A (See note.)	Baud rate
	166	0000	Unit No. 00

Note Set the baud rate to the same value as for the PT unit.

Setting the Front Panel Switches

Set the DIP switch on the front panel to enable the PLC Setup Area settings, as follows:

When using the serial port 1, set SW4 to OFF. When using the serial port 2, set SW5 to OFF. CP1L-L has only one serial port. Therefore there is no DIP switch SW5.

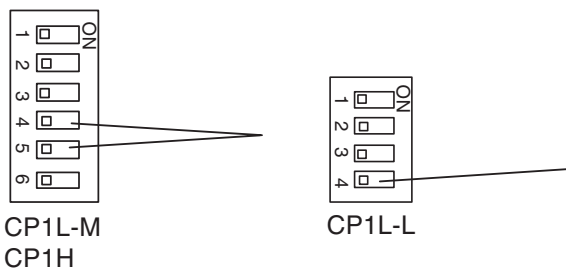

Connecting C-series CPU Unit

C200HX/HG/HE(-Z), CPM1, CPM2A, CPM2C, CQM1, CQM1H CPU Unit and SRM1

Connecting C-series CPU Unit

PLC model	RS-232C method	RS-422A method
CQM1	<ul style="list-style-type: none"> Connect to the CPU Unit's built-in RS-232C port. 	---
C200HX/HG/HE (-Z)	<ul style="list-style-type: none"> Connect to the CPU Unit's built-in RS-232C port. Connect to one of the RS-232C ports (port A or port B) on a Communications Board. 	<ul style="list-style-type: none"> Connect to the RS-422A port (port A) on a Communications Board.
CPM1A	<ul style="list-style-type: none"> Connect to the peripheral port through a CPM1-CIF01 RS-232C Adapter. 	<ul style="list-style-type: none"> Connect to the peripheral port through a CPM1-CIF11 RS-422A Adapter.
CPM2A, SRM1	<ul style="list-style-type: none"> Connect to the CPU Unit's built-in RS-232C port. Connect to the peripheral port through a CPM1-CIF01 RS-232C Adapter. 	<ul style="list-style-type: none"> Connect to the peripheral port through a CPM1-CIF11 RS-422A Adapter.
CPM2C	<ul style="list-style-type: none"> Connect to the CPU Unit's RS-232C port or the peripheral port through a Connecting Cable (CPM2C-CN111, CS1W-CN118, or CS1W-CN114). (The CPM2C-CN111 splits the Unit's communications port into an RS-232C port and a peripheral port. A CPM1-CIF01 RS-232C Adapter is also required to connect to this peripheral port.) 	<ul style="list-style-type: none"> Connect to the peripheral port (on a CPM2C-CN111 or CS1W-CN114 Connecting Cable) through a CPM1-CIF11 RS-422A Adapter. (The CPM2C-CN111 splits the Unit's communications port into a RS-232C port and a peripheral port.)
CQM1H	<ul style="list-style-type: none"> Connect to the CPU Unit's built-in RS-232C port. Connect to the peripheral port through a CS1W-CN118 Connecting Cable. Connect to the RS-232C port (port 1) on a Serial Communications Board. 	<ul style="list-style-type: none"> Connect to the RS-422A port (port 2) on a Serial Communications Board.

PLC Setup Area

Write the settings directly from the Programming Device or Support Software (CX-Programmer, etc.) to the PLC Setup Area (Data Memory) according to the host type and port used.

Using RS-232C

Host type	Address	Write value	Settings
Built-in RS-232C port of C200HX/HG/HE(-Z), CPM2A, CPM2C, CQM1, CQM1H and SRM1	DM6645	0001	Uses Host Link
	DM6646	03□□ (See note 3.)	Standard (See note 4.)
	DM6648	0000	Unit No.00
CPM1A	DM6650	0001	Uses Host Link
	DM6651	03□□ (See note 3.)	Standard (See note 4.)
	DM6653	0000	Unit No.00
Port A of C200HX/HG/HE(-Z) (See note 1.) Port 1 of CQM1H (See note 2.)	DM6555	0001	Uses Host Link
	DM6556	03□□ (See note 3.)	Standard (See note 4.)
	DM6558	0000	Unit No.00
Port B of C200HX/HG/HE(-Z) (See note 1.)	DM6550	0001	Uses Host Link
	DM6551	03□□ (See note 3.)	Standard (See note 4.)
	DM6553	0000	Unit No.00

- Note**
- (1) RS-232C port of Communications Board.
 - (2) RS-232C port of Serial Communications Board.
 - (3) □□ is the setting value of communication speed. Set the same value as for the PT unit.
 - (4) "Standard" in the communication settings refers to the following settings.
Start bit: 1 bit, Data bit: 7bits, Stop bit: 2 bits, Parity: Even

Using RS-422A

Host type	Address	Write value	Settings
Port A of C200HX/HG/HE(-Z) (See note 1.)	DM6555	0001	Uses Host Link
	DM6556	03□□ (*3)	Standard (See note 4.)
	DM6558	0000	Unit No.00
Port 2 of CQM1H (See note 2.)	DM6650	0001	Uses Host Link
	DM6651	03□□ (*3)	Standard (See note 4.)
	DM6653	0000	Unit No.00

- Note**
- (1) RS-422A port of Communications Board.
 - (2) RS-422A port of Serial Communications Board.
 - (3) □□ is the setting value of communication speed. Set the same value as for the PT unit.
 - (4) "Standard" in the communication settings refers to the following settings.
Start bit: 1 bit, Data bit: 7bits, Stop bit: 2 bits, Parity: Even

Refer to the manuals of the PLC being used for details on using the PLC Setup Area.

Connecting to CPM2C PLCs

The CPM2C has a single connector that is the same shape as a CS-series peripheral port. Internally, the connector has signal lines that are for use with the CPU's built-in RS-232C port and the peripheral port. Therefore, when using the CPM2C, use the settings for the CPU's built-in RS-232C port or for the peripheral port according to the converter cable and port used. When using a CPM2C-CIF21 Simplified Communications Unit, connect it to the RS-232C port.

Refer to the *CPM2C Operation Manual (W356)* for details.

Use CS1W-CN118 Connecting Cable to connect the CPM2C to the NP-series PT using the built-in RS-232C port of the CPM2C. The peripheral port cannot be used to connect the PT.

Port for connecting PT	PLC Setup
CS1W-CN118 port (D-Sub 9-pin)	Set for built-in RS-232C.

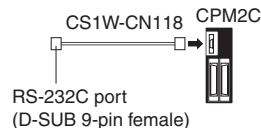

When using a CPM2C1-CIF21 Simplified Communications Unit, connect it to the RS-232C port.

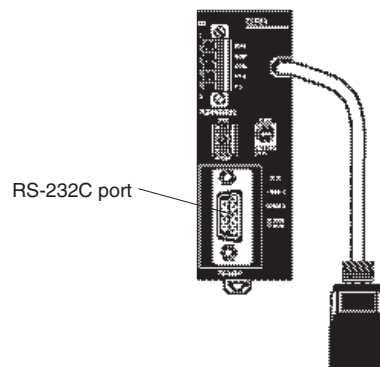

Setting the Front Panel Switches

Set the switch on the front panel to enable the PLC Setup Area settings, as follows:

Setting the Switches on RS-232C of C200HX/HG/HE(-Z), CQM1 and CQM1H

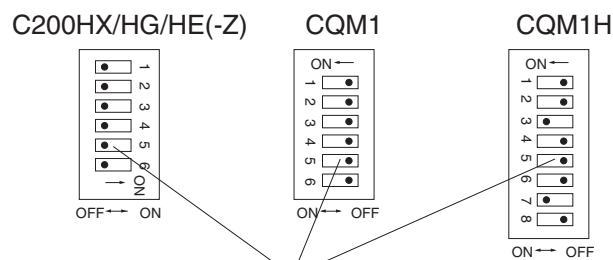

RS-232C Communications Conditions Setting
 Set pin 5 of the DIP switch to OFF to enable the PLC Setup Area settings.

Setting the Switches of CPM2A

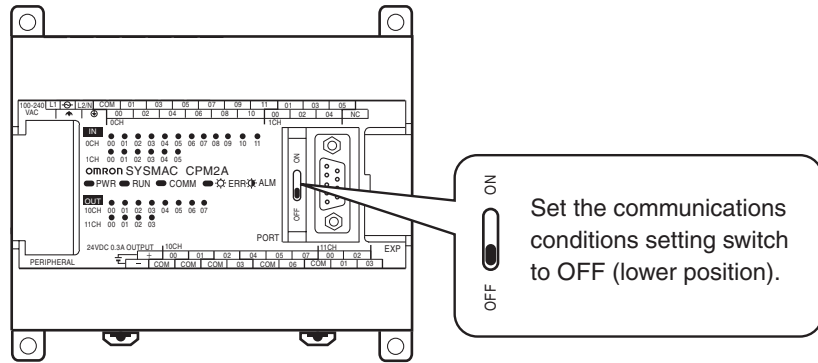

Setting the Switches of CPM2C (Only RS-232C can be connected)

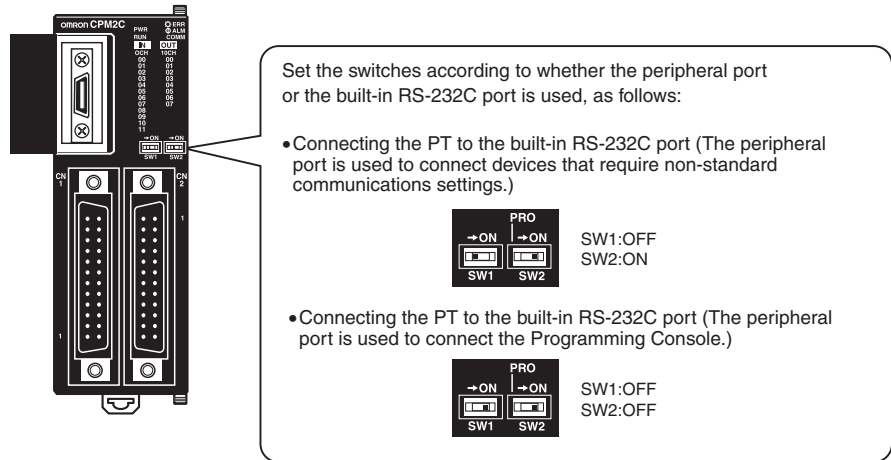

Setting the Communications Board Switches (Using RS-422A)

C200HX/HG/HE(-Z)

Switch 1: 4 (Four-wire method = RS-422A)

Switch 2: ON (terminator ON = terminating resistance used)

CQM1H

Two-wire/four-wire switch (WIRE): 4 (Four-wire method = RS-422A)

Terminating resistance switch (TERM): ON (terminator ON = terminating resistance used)

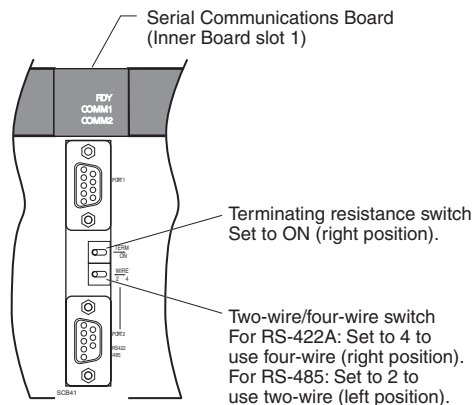

Setting the Switches on a Communication Adapter

Using a CPM1-CIF01 RS-232C Adapter

Set the mode switch to Host (upper position).

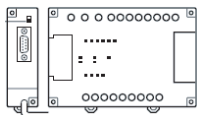

Using a CPM1-CIF11 RS-422 Adapter

Set the terminator selector switch to ON (upper position).

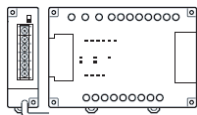

Connecting to CVM1/CV Series (-V□) CPU Units

CV500-CPU01-V1/CV1000-CPU01-V1/CV2000-CPU01-V1
CVM1-CPU01-V2/CVM1-CPU11-V2/CVM1-CPU21-V2

PLC Setup

Set the communication conditions in the Host Link setting of the PLC Setup, as follows.

Item	Setting
Baud rate	Same as the value of the PT
Stop Bits	2 bits
Parity	Even
Data Bits	7 bits
Unit No.	00

Set whether the PLC Setup is set directly from the Programming Device (Programming Console) or created by the Support Software (CX-Programmer) and transferred to the CPU Unit.

For details on the PLC Setup, refer to the *SYSMAC CVM1/CV500/CV1000/CV2000 Programming Manual: Ladder Diagrams (W202-E1-□)*.

Setting the Front Panel DIP Switch

Set the switch as follows.

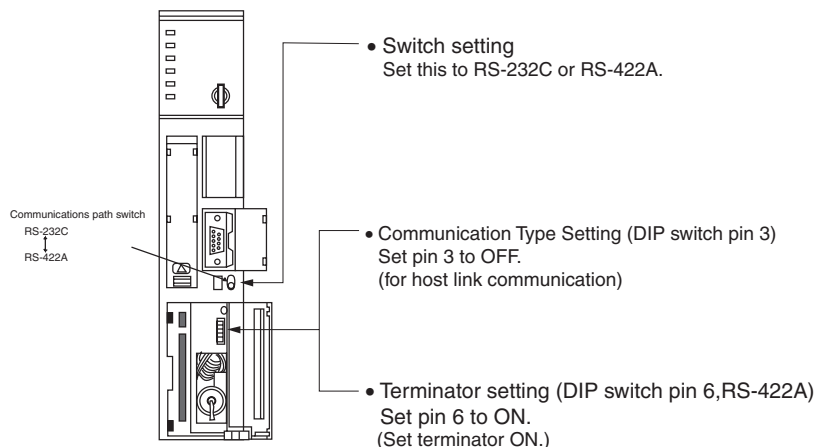

Connecting to CS-Series CPU Units

CS1G/H-CPU□□(-V) and CS1G/H-CPU□□H

Connection Method

Connect to the built-in RS-232C port of the CPU Unit, or the RS-232C port of the Communications Board. Note that the connection to a peripheral port must be made via an RS-232C adapter (CS1W-CN118) specially designed for connecting to a peripheral port.

PLC Setup Area

When connecting to a CS-series CPU Unit, set the following communications conditions for the PLC Setup area according to the communication port used.

Connection Method	Address	Write Value	Setting
Uses built-in RS-232C port of CS1G/H, CS1G/H-H	160	8000	Uses Host Link
	161	0000 to 000A (See note 1.)	Baud rate
	163	0000	Unit No. 00
Uses built-in peripheral port of CS1G/H, CS1G/H-H	144	8000	Uses Host Link
	145	0000 to 000A (See note 1.)	Baud rate
	147	0000	Unit No. 00

Note (1) Set the same baud rate as for the PT.

Set whether the PLC Setup is set directly from the Programming Device (Programming Console) or created by the Support Software (CX-Programmer) and transferred to the CPU Unit.

Refer to the *SYSMAC CS Series Operation Manual (W339)* for information on the PLC.

Setting the Front Panel Switches

Set DIP switch pin 4 or 5 of the CPU Unit according to the port to which the PT is connected, as follows:

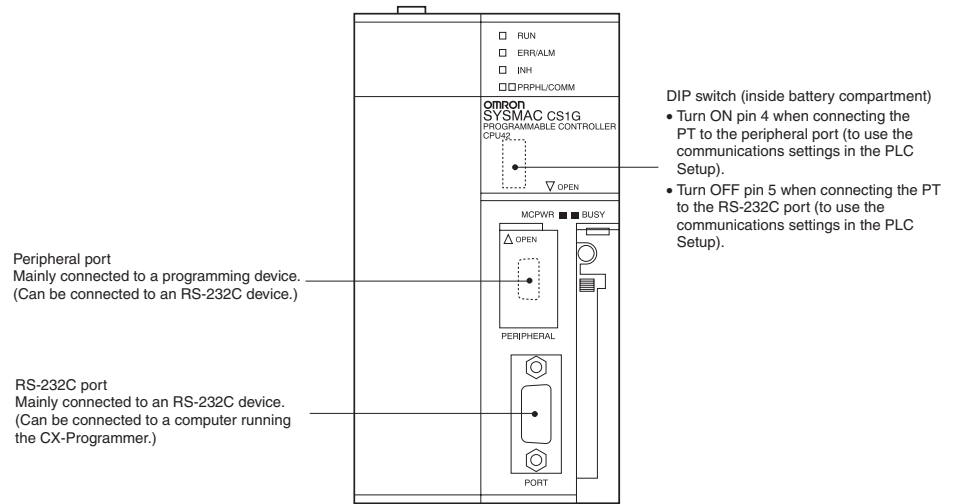

Connecting to CJ-series CPU Units

CJ1G-CPU□□

Connection Method

Connect to the built-in RS-232C port of the CPU Unit, or the RS-232C port of the Communications Board. Note that the connection to a peripheral port must be made via an RS-232C adapter (CS1W-CN118) specially designed for connecting to a peripheral port.

PLC Setup

When connecting to a CJ-series CPU Unit, set the following communications conditions for the PLC Setup area according to the communication unit used.

Connection Method	Address	Write Value	Setting
Uses built-in RS-232C port of CJ1G-CPU□□	160	8000	Uses Host Link
	161	0000 to 000A (See note 1.)	Baud rate
	163	0000	Unit No. 00
Uses peripheral port of CJ1G-CPU□□	144	8000	Uses Host Link
	145	0000 to 000A (See note 1.)	Baud rate
	147	0000	Unit No. 00

Note (1) Set the same baud rate as for the PT.

Set whether the PLC Setup is set directly from the Programming Device (Programming Console) or created using the Support Software (CX-Programmer) and transferred to the CPU Unit.

Refer to the *SYSMAC CJ Series Operation Manual (W393)* for information on PLC Setup.

Setting the Front Panel Switches

Set DIP switch pin 4 or 5 of the CPU Unit according to the port to which the PT is connected, as follows:

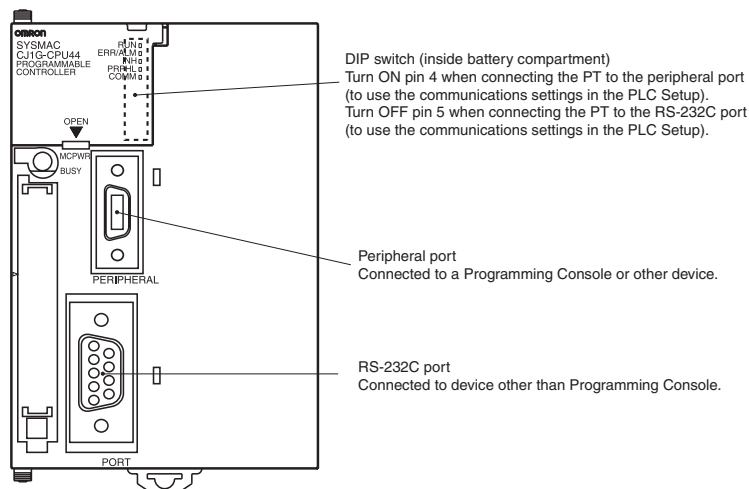

Connecting to a C Series Host Link Unit

- C200H/C200HE(-Z)E/C200HG(-Z)E/C200HX(-Z)E
- Rack-mounted Type: C200H- LK201/LK202-V1
- C1000H/C2000H Rack-mounted Type: C500-LK201-EV1
- 1000H(F)/C2000H Rack-mounted Type: C500-LK203
- C200H/C1000H/C2000H CPU-mounted Type: C120- LK201/LK202-EV1

Setting the Switches

- C200H-LK201-V1 (RS-232C)

Setting the Front Switches

Set each switch with a flat blade screwdriver so that the values or symbols in the setting value window agree with the following.

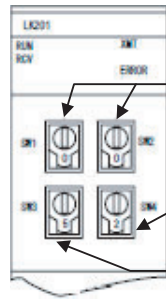

- Unit # (SW1, SW2)
Set these switches to 0.
- Command level, parity, and transfer code (SW4)
Set this switch to 2.
- Communications speed (SW3)
Set this switch to 4 to select 4,800 bps.
Set this switch to 5 to select 9,600 bps.
Set this switch to 6 to select 19,200 bps.

Setting the Rear Switches

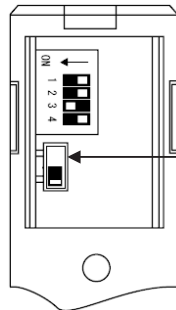

- 1-to-1/1-to-N selection (DIP switch)
Set #3 to ON.
- CTS selection (selection switch)
Set this always to 0 V (ON).

- C200H-LK202-V1 (RS-422A)

Setting the Front Switches

Set each switch with a flat blade screwdriver so that the values or symbols in the setting value window agree with the following.

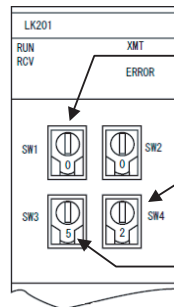

- Unit # (SW1, SW2)
Set these switches to 0.
- Command level, parity, and transfer code (SW4)
Set this switch to 2.
- Communications speed (SW3)
Set this switch to 4 to select 4,800 bps.
Set this switch to 5 to select 9,600 bps.
Set this switch to 6 to select 19,200 bps.

Setting the Rear Switches

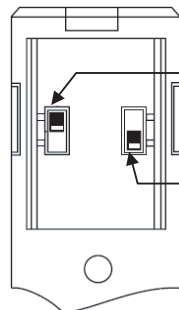

- Terminator setting (selector switch)
Set this switch to ON (upper position).
- 1-to-1/1-to-N protocol selection (selector switch)
Set this switch to 1-to-N (OFF) (lower position).

- C500-LK201-EV1

Setting the Front Switches



- Mode selector (key switch)
Set this to Host link.

Setting the Rear Switches

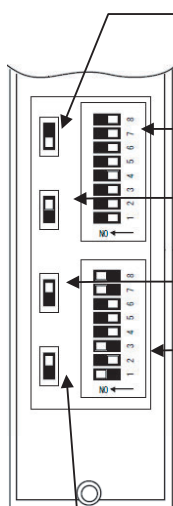

- I/O port selection (selector switch)
Switch this to RS-232C (lower) or RS-422 (upper).
Set this to RS-422 to connect to RS485.
- Unit # (DIP SW1)
Set SW1-1 to SW1-5 to OFF (0).
- Synchronization (selector switch)
Set this to Internal (upper).
- Terminator setting (selector switch)
Set this switch to ON (lower).
- Communications speed (DIP SW2-1 to SW2-4)
Set these switches to 0010 to select 19,200 bps.
Set these switches to 1010 to select 9,600 bps.
Set these switches to 0110 to select 4,800 bps.
(0:OFF 1:ON)
- 1-to-1/1-to-N selection (DIP SW2-6)
Set SW2-6 to OFF (0) (1-to-N).
- Command level (DIP SW2-7, SW2-8)
Set these switches to ON (1).
(Levels 1, 2 and 3 are enabled.)
- CTS selection (selector switch)
Set this always to 0 V (ON) (upper).

- C500-LK203

Setting the Rear Switches

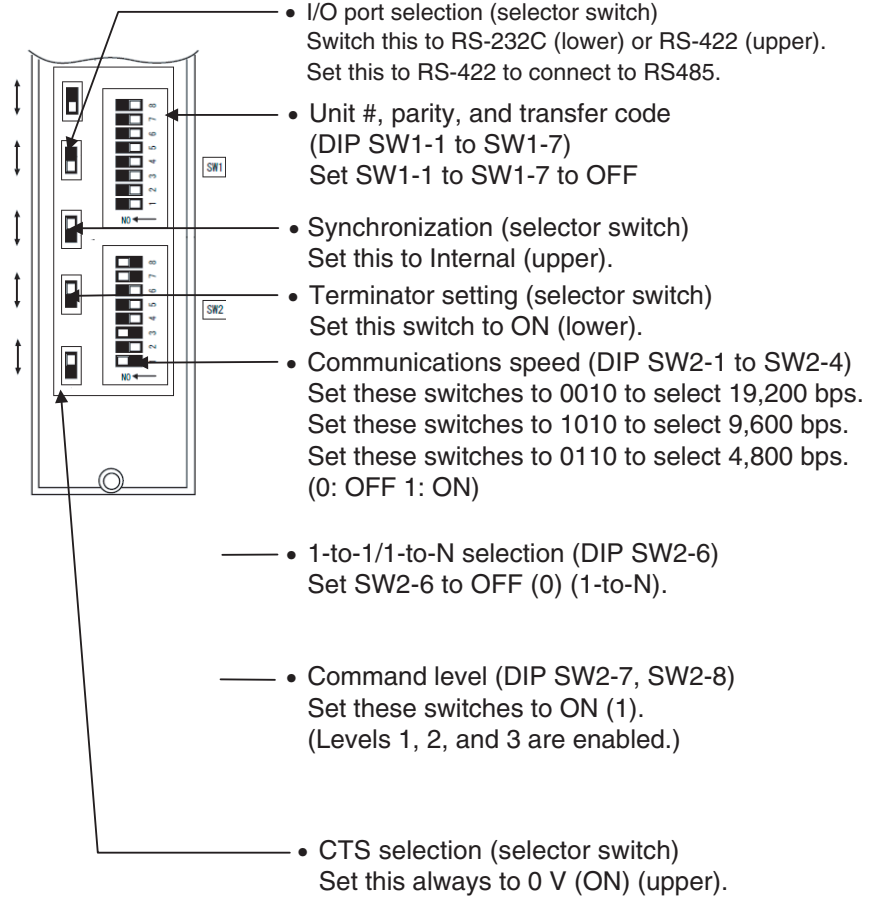

- C120- LK201-V1

Setting the Rear Switches

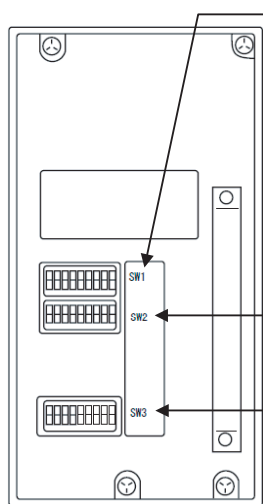

- Unit #, parity, and transfer code (DIP SW1-1 to SW1-5)
Set SW1-1 to SW1-5 to OFF (0).
* Parity is fixed at Even Parity.
Transfer code is fixed at ASCII 7 data bits and 2 stop bits.
- Communications speed (DIP SW2-1 to SW2-4)
Set these switches to 0010 to select 19,200 bps.
Set these switches to 1010 to select 9,600 bps.
Set these switches to 1110 to select 4,800 bps.
(0: OFF 1: ON)
- 1-to-1/1-to-N selection (DIP SW2-6)
Set SW2-6 to OFF (0) (1-to-N).
- Command level (DIP SW2-7, SW2-8)
Set these switches to ON (1).
(Levels 1, 2, and 3 are enabled.)
- CTS selection (DIP SW3-1 and SW3-2)
Set SW3-1 to ON (1), and SW3-2 to OFF (0).
(Set this always to 0V.)
- Synchronization (DIP SW3-3 to SW3-6)
Set SW3-3 and SW3-5 to ON (1), and SW3-4 and SW3-6 to OFF (0).
(Set these to Internal.)

- C120- LK202-V1

Setting the Rear Switches

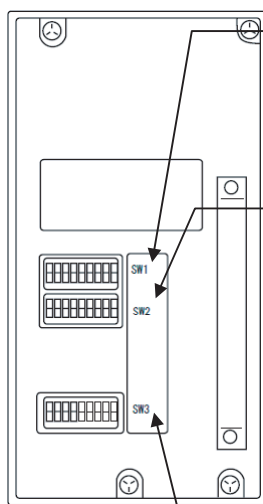

- Unit #, parity, and transfer code (DIP SW1-1 to SW1-5)
Set SW1-1 to SW1-5 to OFF (0).
* Parity is fixed at Even Parity.
Transfer code is fixed at ASCII 7 data bits and 2 stop bits.
- Communications speed (DIP SW2-1 to SW2-4)
Set these switches to 0010 to select 19200 bps.
Set these switches to 1010 to select 9600 bps.
Set these switches to 0110 to select 4,800 bps.
(0: OFF 1: ON)
- 1-to-1/1-to-N selection (DIP SW2-6)
Set SW2-6 to OFF (0) (1-to-N).
- Command level (DIP SW2-7, SW2-8)
Set these switches to ON (1).
(Levels 1, 2, and 3 are enabled.)
- Terminator setting (DIP SW3-3 to SW3-6)
Set SW3-1, SW3-3 and SW3-5 to ON (1),
and SW3-2, SW3-4 and SW3-6 to OFF (0).
(Set these to on.)

Connecting to CVM1/CV Series Host Link Units

CVM1/CV-series Rack-mounted type: CV500-LK201

Connection Method

A CVM1/CV series host link unit (CV500-LK201) has two connectors (communications ports 1 and 2).

- Communications port 1
Communications port 1 is a 25-pin connector for RS-232C use only.
- Communications port 2
Communications port 2 is a 9-pin connector which allows selection of the RS-232C or RS-422A method. To make the selection, use the Communications path switch on the front panel.

Setting the Front Panel Switches

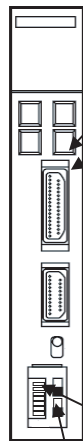

- Unit # (SW3, SW4)
When using communication port 2, set these switches to 0.
- Communications path switch (selector switch)
Switch this to RS-232C (lower) or RS-422 (upper). Set this to RS-422 to connect to RS485.
- CTS selection (DIP Switch pin 2 and 3)
Set pin 2 or 3 to ON. (Set this always to 0V.) To use communication port 1, set pin 2. To use communication port 2, set pin 3.
- Communication condition setting (DIP switch pin 1)
Set this switch to OFF.
Communication is executed in accordance with the CPU bus unit system settings made at the PLC. The initial values for the system settings are as follows.
 - Communications speed: 9600 bps
 - Parity: Even
 - Xon/Xoff control: Not executed
 - Communication method: Full duplex
 - Stop bits: 2 stop bits
 - Data length: 7 bits
- Terminator setting (selector switch)
Set this switch to ON (upper position).

Connecting to CS-series Serial Communications Boards

Serial Communications Boards with RS-232C and RS-422A Ports for Use with CS-series CPU Units:

- CS1W-SCB21 (Both ports 1 and 2 are RS-232C ports.)
- CS1W-SCB41 (Port 1 is an RS-232C port and Port 2 is an RS-422A port.)

Setting DM Area Allocations in CPU Unit

Write the settings directly from the Programming Device or Support Software (Programming Console or CX-Programmer) to the DM Area (Parameter Area) in the CPU Unit. After writing the settings, enable the settings by turning ON the power again, restarting the Unit, restarting the communications port, or executing the CHANGE SERIAL PORT SETUP (STUP) instruction.

The following table shows the allocated DM Area words and settings.

The allocations and settings are the same for RS-232C and RS-422A (CS1W-SCB41 Port 2).

Allocated DM Area words		Write value	Settings
Port 1	Port 2		
DM32000	DM32010	8000	Host Link Mode
DM32001	DM32011	0000 to 000A (See note 1.)	Baud rate
DM32003	DM32013	0000	Unit No. 00

Note (1) Set the baud rate to the same value as that of the PT.

Setting the Front Panel Switches

Using RS-422A

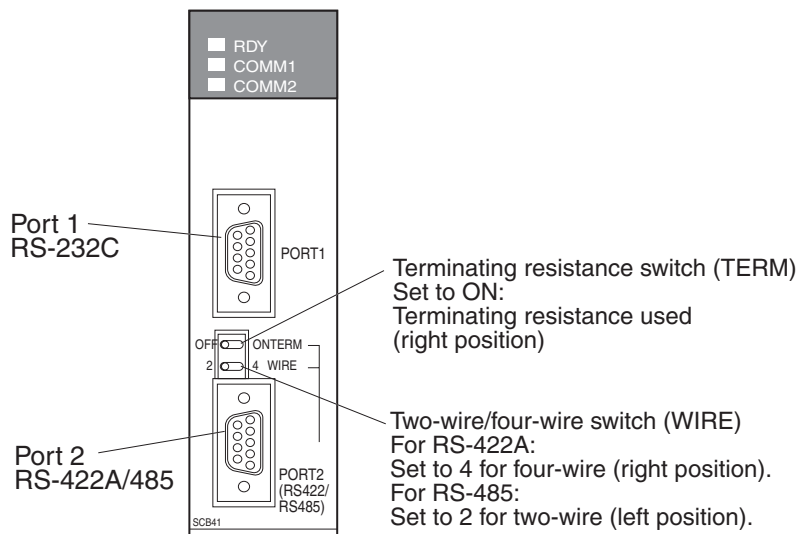

Connecting to CS-series Serial Communications Units

CS1W-SCU21 (Both ports 1 and 2 are RS-232C ports.)

CPU Unit DM Area Settings

Write the settings directly from the Programming Device or Support Software (Programming Console or CX-Programmer) to the DM Area (Parameter Area) in the CPU Unit. After writing the settings, enable the settings by turning ON the power again, restarting the Unit, restarting the communications port, or executing the CHANGE SERIAL PORT SETUP (STUP) instruction.

The following table shows the allocated DM Area words and settings.

$$m = 30000 + 100 \times \text{unit number}$$

Allocated DM Area words		Write value	Settings
Port 1	Port 2		
DM m	DM m+10	8000	Host Link Mode
DM m+1	DM m+11	0000 to 000A (See note 1.)	Baud rate
DM m+3	DM m+13	0000	Unit No. 00

Note (1) Set the baud rate to the same value as that of the PT.

Setting the Front Panel Switches

Set the unit number of the Serial Communications Unit with the rotary switches on the front of the Unit. Use a flat-blade screwdriver to set the numerals and symbols in the switches setting display window, as follows:

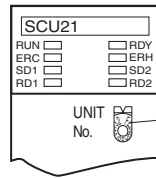

- Unit number setting
Set a value between 0 and F that is not the same as that of other Units.

Connecting to CS-series Serial Communications Units

CS-series Rack-mounted Type:

CJ1W-SCU41 (Port 1 is an RS-422A port and Port 2 is an RS-232C port.)

CPU Unit DM Area Settings

Write the settings directly from the Programming Device or Support Software (Programming Console or CX-Programmer) to the DM Area (Parameter Area) in the CPU Unit. After writing the settings, enable the settings by turning ON the power again, restarting the Unit, restarting the communications port, or executing the CHANGE SERIAL PORT SETUP (STUP) instruction.

The following table shows the allocated DM Area words and settings.

The allocations and settings are the same for RS-232C and RS-422A.

$$m = 30000 + 100 \times \text{unit number}$$

Allocated DM Area words		Write value	Settings
Port 1	Port 2		
DM m	DM m+10	8000	Host Link Mode
DM m+1	DM m+11	0000 to 000A (See note 1.)	Baud rate
DM m+3	DM m+13	0000	Unit No. 00

Note (1) Set the baud rate to the same value as that of the PT.

Setting the Front Panel Switches

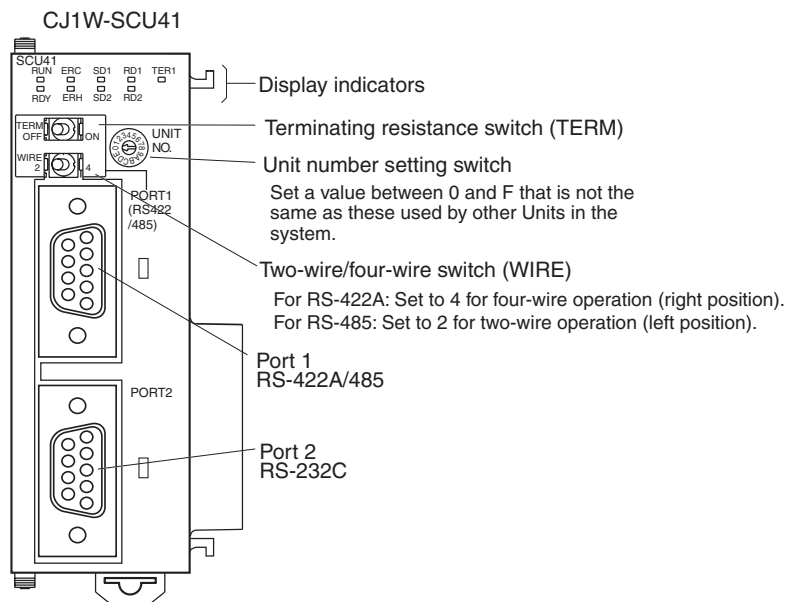

3-8 Connecting to Temperature Controllers

3-8-1 Overview

The PT can communicate with up to 31 of EJ1 modular temperature controllers via RS-485 using the PT's COM2 serial port. The PT can also communicate with other host via RS-232C using the COM1 serial port while communicating with the EJ1.

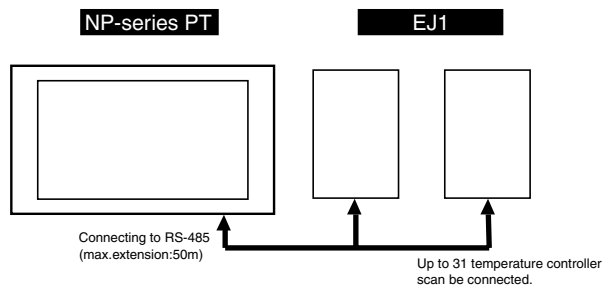

3-8-2 Wiring

The PT's COM2 is connected to the EJ1's port B via RS-485. For details on the cable wiring diagram, please refer to *Appendix D Preparing Connecting Cables* for Host Connection.

3-8-3 Communications Settings

Set the communication settings of the EJ1 modular temperature controller and PT.

The communications settings must be set for the PT using the NP-Designer. For information on how to set EJ1 modular temperature controller, please refer to *EJ1 Modular Temperature Controller User's Manual*. For information on how to set communication details using the NP-Designer, please refer to *6-2-4 PT Menu*.

3-9 Using USB Flash Memory

USB flash memory can be used with the PT to perform the following operations.

- Transferring screen data from the computer to the PT
- Transferring screen data from the PT to the computer
- Updating the PT system

**Precautions
for Correct Use**

Only FAT 32 formatted USB flash memory can be used.

3-9-1 Transferring Data with USB Flash Memory

Transferring Screen Data from the Computer to the PT

Use the following procedure to transfer screen data created with the NP-Designer to the PT.

- 1,2,3...**
1. Insert the USB flash memory into the computer.
 2. Use the NP-Designer's File Menu to transfer the screen data to the USB flash memory. Refer to *6-2-1 File Menu*.
 3. Set the SW1 slide switch on the back of the PT to ON (left position). Then turn the power of the PT to OFF and then ON. The system menu will be started.
 4. Remove the USB flash memory from the computer. Then insert it to the USB (host) connector on the back of the PT. Unless the buzzer is turned OFF, the PT will make a peeping sound when it detects the USB flash memory.
 5. Use the file menu of the system menu to transfer the screen data stored in the USB flash memory to the PT. For details, refer to *SECTION 4 System Menu* for details.
 6. Remove the USB flash memory from the PT.
 7. Set the SW1 slide switch on the back of the PT to OFF (right position).

Transferring Screen Data from the PT to the Computer

Use the following procedure to transfer screen data from the PT to the computer.

- 1,2,3...**
1. Insert the USB flash memory to the USB (host) connector on the back of the PT.
 2. Set the SW1 slide switch on the back of the PT to ON (left position). Then turn the power of the PT to OFF and then ON. The system menu will be started.
 3. Use the file menu of the system menu to transfer the screen data stored in the USB flash memory to the PT. For details, refer to *SECTION 4 System Menu*.
 4. Remove the USB flash memory from the PT.
 5. Insert the USB flash memory into the computer.
 6. Use the File Menu from the NP-Designer to transfer the screen data stored in the USB flash memory to the PT. For details, refer to *6-2-1 File Menu*.
 7. Remove the USB flash memory from the computer.

Updating the PT system

Use the following procedure to update the PT system.

- 1,2,3...**
1. Insert the USB flash memory into the computer.
 2. Use the File Menu from the NP-Designer to transfer the system program to the USB flash memory. For details, refer to *6-2-1 File Menu*.
 3. Remove the USB flash memory from the computer. Then insert it into the USB (host) connector.
 4. Set the SW1 slide switch on the back of the PT to ON (left position). Then turn the power of the PT to OFF and then ON. The system menu is started up.
 5. Use the file menu of the system menu to transfer the system program stored in the USB flash memory to the PT. For details, refer to *SECTION 4 System Menu*.
 6. Remove the USB flash memory from the PT.

Precautions for Correct Use

- Do not perform the following operations while accessing the USB flash memory. The data may be damaged and the USB flash memory may need to be formatted.
 - Turn OFF the power to the PT.
 - Remove the USB flash memory.
- Always follow the procedure for removing the USB flash memory from the computer.

If the PT system is damaged due to the power being turned OFF while a file is being transferred, or other reason, using normal downloading to replace the system programs may not be possible. For details on troubleshooting, refer to *7-3 Troubleshooting*.

SECTION 4

System Menu

This section describes the System Menu.

4-1	Displaying System Menu	64
4-2	Functions of System Menu	65

4-1 Displaying System Menu

Use one of the following methods to display the System Menu.

- 1,2,3...**
1. Press a Function Switch to which a function that can switch a screen to the System Menu is allocated.
For details on Function Switch, refer to *6-2-6 Screen Menu*.
 2. Press a button to which a function that can switch a screen to the System Menu is allocated.
 3. Set the SW1 (slide switch) on the back to the left (ON) and start the PT.

4-2 Functions of System Menu



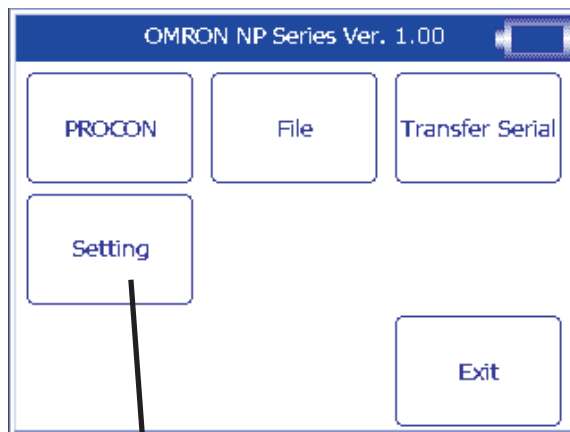



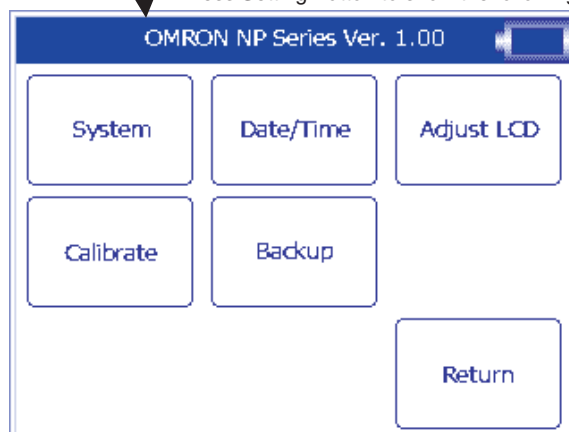



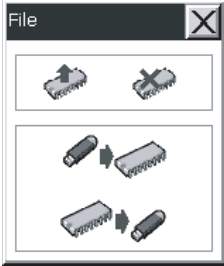

The following buttons are displayed on the System Menu.





Press Setting Button to show the following screen.



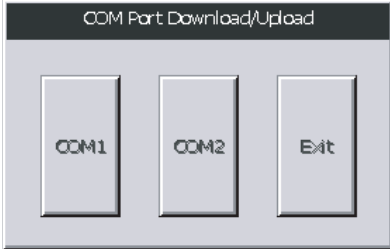

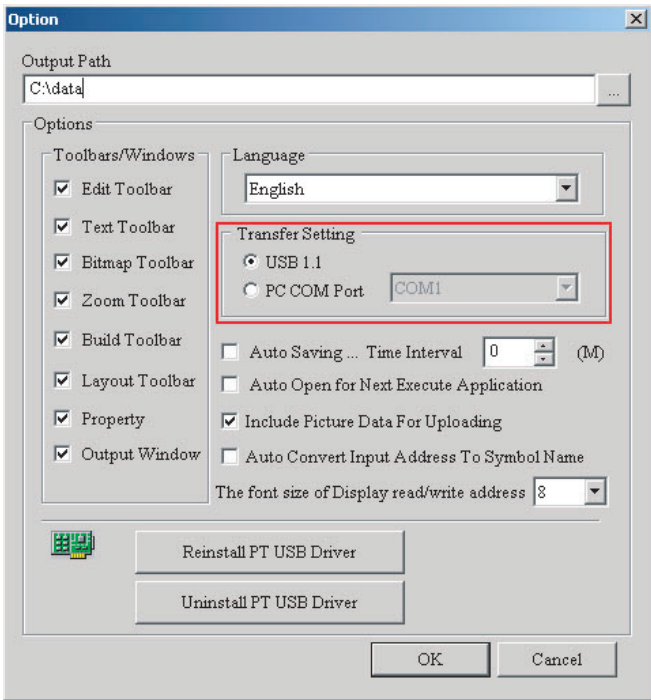

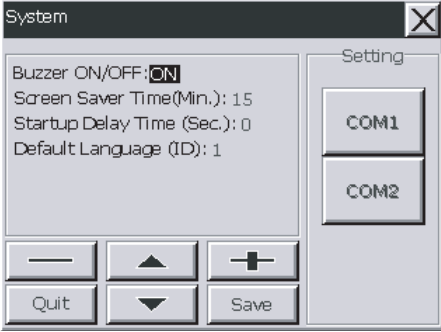



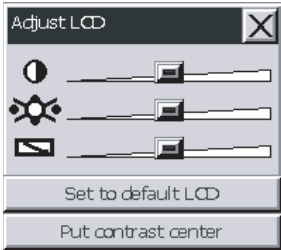

This table describes the function of each button.

Item	Functions								
PROCON	<p>Starts Programming Console functions.</p> <p>Set the protocol to <i>NT link (1:N)</i> (standard or high-speed) and set the <i>NT/PC Link Max.</i> parameter to 0 in the PLC Setup. The Programming Console functions will work only with the 1:N NT Link protocol. It will not work with other protocols. Use a 1:1 connection with a 1:N NT Link connection configuration (standard or high-speed).</p> <p>For details on Programming Console operations, refer to <i>Programming Console Operation Manual (W341)</i></p> <p>To change the language of the key operation descriptions, press the 3 Key when the LCD shows “JPN→ENG” or “ENG→JPN.”</p>								
File	<p>Transfers screen data and system using a USB flash memory.</p> <div data-bbox="663 583 887 849" style="border: 1px solid black; padding: 5px; margin-bottom: 10px;">  </div> <table border="1" style="width: 100%; border-collapse: collapse;"> <tr> <td data-bbox="384 863 651 949" style="text-align: center;"></td> <td data-bbox="655 863 1444 949">Updates system using a USB flash memory.</td> </tr> <tr> <td data-bbox="384 955 651 1040" style="text-align: center;"></td> <td data-bbox="655 955 1444 1040">Initializes the user area of the PT.</td> </tr> <tr> <td data-bbox="384 1046 651 1132" style="text-align: center;"></td> <td data-bbox="655 1046 1444 1132">Downloads screen data from a USB flash memory.</td> </tr> <tr> <td data-bbox="384 1138 651 1215" style="text-align: center;"></td> <td data-bbox="655 1138 1444 1215">Uploads screen data to a USB flash memory.</td> </tr> </table>		Updates system using a USB flash memory.		Initializes the user area of the PT.		Downloads screen data from a USB flash memory.		Uploads screen data to a USB flash memory.
	Updates system using a USB flash memory.								
	Initializes the user area of the PT.								
	Downloads screen data from a USB flash memory.								
	Uploads screen data to a USB flash memory.								
Transfer Serial	<p>Transfers screen data and system via a COM port.</p> <p>Select the port to be used in the COM Port Upload/Download Dialog Box so that the PT prepares to receive screen data.</p> <div data-bbox="663 1321 1054 1570" style="border: 1px solid black; padding: 10px; margin-bottom: 10px;">  </div> <p>To transfer data using a COM port, select PC COM Port option in the Option Dialog Box from Tools Menu of the NP-Designer.</p>								

Item	Functions
Transfer Serial	 <p>The screenshot shows the 'Option' dialog box for the 'Transfer Serial' function. The 'Output Path' is set to 'C:\data'. Under the 'Options' section, the 'Toolbars/Windows' list includes 'Edit Toolbar', 'Text Toolbar', 'Bitmap Toolbar', 'Zoom Toolbar', 'Build Toolbar', 'Layout Toolbar', 'Property', and 'Output Window', all of which are checked. The 'Language' is set to 'English'. The 'Transfer Setting' section, highlighted with a red box, shows 'USB 1.1' selected with a radio button, and 'PC COM Port' selected with a radio button and a dropdown menu set to 'COM1'. Other options include 'Auto Saving ... Time Interval' (0 M), 'Auto Open for Next Execute Application', 'Include Picture Data For Uploading' (checked), and 'Auto Convert Input Address To Symbol Name'. At the bottom, there are buttons for 'Reinstall PT USB Driver', 'Uninstall PT USB Driver', 'OK', and 'Cancel'.</p>

Item	System	Functions								
Settings	System	<p>Sets the standard settings and communications settings.</p> <p>1. Standard Settings</p>  <table border="1" data-bbox="700 672 1398 925"> <tr> <td>Buzzer ON/OFF</td> <td>Sets whether a buzzer sound is heard or not.</td> </tr> <tr> <td>Screen Saver Time (Min.)</td> <td>Sets the duration of time before the screen saver starts. The unit is minute.</td> </tr> <tr> <td>Startup Delay Time (Sec)</td> <td>Sets the duration of time before the PT starts. The unit is second.</td> </tr> <tr> <td>Default Language (ID)</td> <td>Sets the default language when using more than one language.</td> </tr> </table> <p>2. Communications settings Sets the communication settings of each COM port.</p> 	Buzzer ON/OFF	Sets whether a buzzer sound is heard or not.	Screen Saver Time (Min.)	Sets the duration of time before the screen saver starts. The unit is minute.	Startup Delay Time (Sec)	Sets the duration of time before the PT starts. The unit is second.	Default Language (ID)	Sets the default language when using more than one language.
Buzzer ON/OFF	Sets whether a buzzer sound is heard or not.									
Screen Saver Time (Min.)	Sets the duration of time before the screen saver starts. The unit is minute.									
Startup Delay Time (Sec)	Sets the duration of time before the PT starts. The unit is second.									
Default Language (ID)	Sets the default language when using more than one language.									
	Date/Time	<p>Sets the date and time.</p> 								

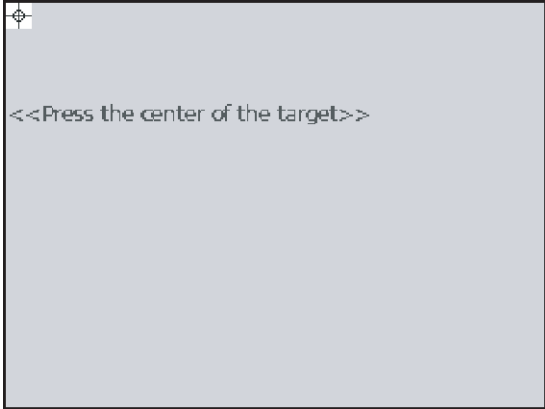
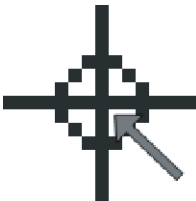
Item	Functions										
Settings	<p data-bbox="389 210 517 236">Adjust LCD</p> <p data-bbox="660 210 863 236">Adjusts the display.</p>  <p data-bbox="660 512 1406 538">The default settings may not be the most suitable settings for the LCD.</p> <table border="1" data-bbox="427 544 1442 838"> <tr> <td data-bbox="435 544 651 608"></td> <td data-bbox="660 544 1442 608">Adjusts the contrast.</td> </tr> <tr> <td data-bbox="435 608 651 672"></td> <td data-bbox="660 608 1442 672">Adjusts the brightness. NP5 does not support this function.</td> </tr> <tr> <td data-bbox="435 672 651 736"></td> <td data-bbox="660 672 1442 736">Adjusts the refresh rate.</td> </tr> <tr> <td data-bbox="435 736 651 778">Set to Default LCD</td> <td data-bbox="660 736 1442 778">Sets to the default settings.</td> </tr> <tr> <td data-bbox="435 778 651 838">Put Contrast Center</td> <td data-bbox="660 778 1442 838">Sets the contrast to the center value.</td> </tr> </table>		Adjusts the contrast.		Adjusts the brightness. NP5 does not support this function.		Adjusts the refresh rate.	Set to Default LCD	Sets to the default settings.	Put Contrast Center	Sets the contrast to the center value.
	Adjusts the contrast.										
	Adjusts the brightness. NP5 does not support this function.										
	Adjusts the refresh rate.										
Set to Default LCD	Sets to the default settings.										
Put Contrast Center	Sets the contrast to the center value.										
	<p data-bbox="389 844 491 870">Calibrate</p> <p data-bbox="660 844 1430 895">Calibrates the displayed position of the screen and the actual position of the touch panel.</p> <p data-bbox="660 906 1362 957">Markers will appear at the upper left, lower right, and center of the screen. Press each marker in order.</p>  <p data-bbox="660 1402 1430 1427">Be sure to press the very center of the markers displayed on the screen.</p>  <p data-bbox="660 1661 1430 1742">Calibrate the screen approximately once every six months under normal conditions and operation. If the PT is used in a severe environment, calibrate the screen more often.</p> <table border="1" data-bbox="389 1747 1442 1853"> <tr> <td data-bbox="389 1747 651 1810">Backup</td> <td data-bbox="660 1747 1442 1810">Backups data when the battery is replaced. For details, refer to <i>Replacing the Battery</i> in 7-1 Maintenance.</td> </tr> <tr> <td data-bbox="389 1810 651 1853">Return</td> <td data-bbox="660 1810 1442 1853">Returns to the initial screen of the System Menu.</td> </tr> </table>	Backup	Backups data when the battery is replaced. For details, refer to <i>Replacing the Battery</i> in 7-1 Maintenance.	Return	Returns to the initial screen of the System Menu.						
Backup	Backups data when the battery is replaced. For details, refer to <i>Replacing the Battery</i> in 7-1 Maintenance.										
Return	Returns to the initial screen of the System Menu.										
Exit	<p data-bbox="660 1859 1442 1964">Exits the System Menu and switches to the user screen. Even if Exit Button is pressed, the System Menu will not be switched to the user screen when the System Menu was displayed by using a switch on the back of the PT.</p>										

SECTION 5

Installing and Starting NP-Designer

Make sure that you install the NP-Designer on the computer before you use it for the first time. NP-Designer is application software that runs on a Windows 2000 or XP operating system.

5-1	Preparing	72
5-2	Installing/Uninstalling	73
5-2-1	Installing	73
5-2-2	Uninstalling	73
5-3	Starting/Exiting NP-Designer	74
5-3-1	Starting	74
5-3-2	Exiting	74
5-4	Installing USB Drivers for NP-series PTs	75

5-1 Preparing

This table shows the system requirements for the NP-Designer.

System Requirements

Item	Minimum Requirements
Operating System (OS)	Microsoft Windows 2000 (Service Pack 4) Microsoft Windows XP (Service Pack 2)
CPU	Pentium III 500 MHz (Pentium III 1 GHz or faster recommended.)
Memory	256 MB
Hard Disk	100 MB
Display	SVGA (800 x 600) 256 colors
Communications port	USB port RS-232C port

5-2 Installing/Uninstalling

5-2-1 Installing

- 1,2,3...
1. Start Windows 2000 or XP.
 2. Put the NP-Designer CD-ROM in the CD-ROM drive.
The setup program starts automatically.
Double-click **Setup.exe** to start the setup program in this condition:
 - The setup program does not start automatically
 3. Select a setup language.
 4. Click **OK** to show the **Select Installation Folder** Dialog Box.
 5. Click **Next>** Button to select the default directory C:\Program Files\OMRON\NP-Designer.
Click **Browse** Button to select a directory.
You will see a list of available directories.
Select a directory for the NP-Designer, and click **OK** Button.
Click **Next>** Button for the subsequent step.
The **Select Components** Dialog Box shows.
 6. Click **Install** Button.
 7. Click **Close** Button to complete the setup. (If a dialog box that relates to a logo testing shows, press **Continue Anyway** Button.)
 8. The Software Installation Dialog Box will be displayed. Click the **Continue** Button.

5-2-2 Uninstalling

To uninstall the NP-Designer, select [Start]-[Program]-[OMRON]-[NP-Designer]-[Uninstall].

5-3 Starting/Exiting NP-Designer

5-3-1 Starting

Click the Windows **Start** Button.

Select **All Programs – OMRON – NP-Designer**.

- The file that you used last time will open automatically if you select **Auto Open for Next Execute Application** in the Option Dialog Box.
- You will see this window when
 - You do not select **Auto Open for Next Execute Application** in the Option Dialog Box or,
 - You start the NP-Designer for the first time.

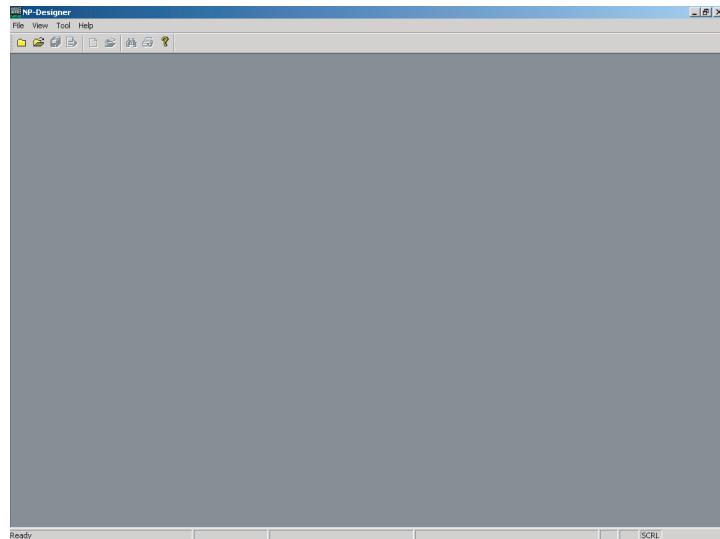

5-3-2 Exiting

Use one of these operations to exit the NP-Designer.

- Select **Exit Button** from the **File** Menu.
- Click **Close Button** at the top right corner of the main window.
- Double-click the NP-Designer icon at the top left corner of the main window.
- Click the NP-Designer icon at the top left corner of the main window, and select **Close Button** from the control menu box.
- Use the keyboard shortcut Alt + F4 Keys.

If you did not save the project data that is open, you will see a confirmation message.

5-4 Installing USB Drivers for NP-series PTs

Install the NP-series USB driver in the personal computer. After installation, data can be transferred between the personal computer and NP-series PT via USB.

Operation Procedure

1,2,3...

1. Connect the personal computer to the NP-series PT USB slave connector using the USB cable. The following Found New Hardware Wizard will be displayed. Select **Install the software automatically (Recommended)**. Click the **Next** Button.

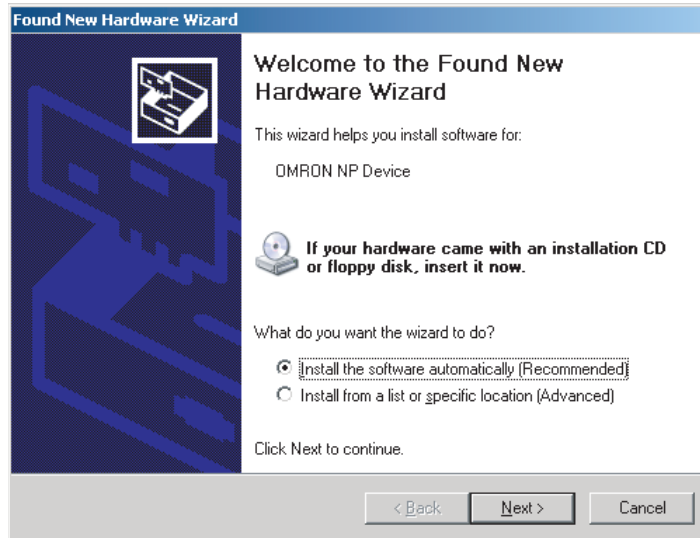

2. The dialog box shown below will be displayed. Click the **Continue Anyway** Button.



- When installation is completed, the following dialog box will be displayed. Click the **Finish** Button.



When the USB Drivers Cannot Be Installed by Following the Above Procedure

- 1,2,3...** 1. Connect the personal computer to the NP-series PT USB slave connector using the USB cable. The following Found New Hardware Wizard will be displayed. Select **Install from a list or specific location (Advanced)**. Click the **Next** Button.

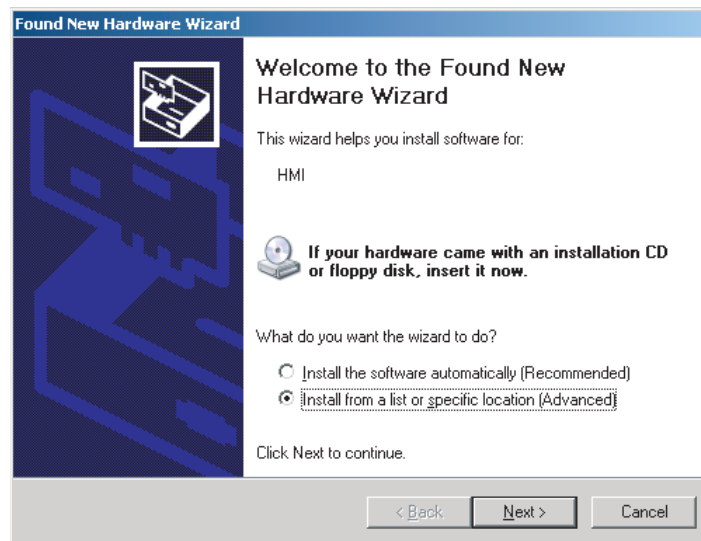

- The dialog box shown below will be displayed. Confirm that **Search for the best driver in these locations** is selected. Select the **Include this location in the search** option, click the **Browse** Button and specify the following folder:
C:\Program Files\OMRON\NP-Designer\ScrEditApp
Click the **Next** Button.

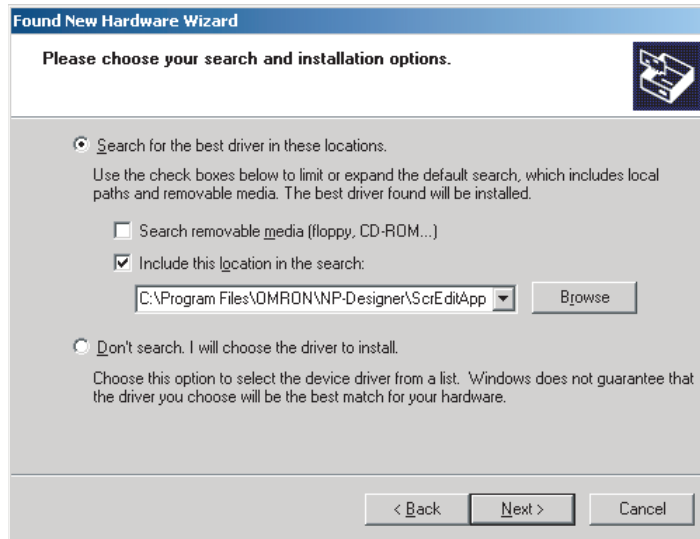

3. The dialog box shown below will be displayed. Click the **Continue Anyway** Button.



4. When installation is completed, the following dialog box will be displayed. Click the **Finish** Button.



SECTION 6

NP-Designer Functions

This section describes the action to take when NT30/30C errors occur, and how to carry out maintenance and inspections to prevent the occurrence of errors.

6-1	User Interface	80
6-2	Menus	82
6-2-1	File Menu	82
6-2-2	Edit Menu	87
6-2-3	View Menu	95
6-2-4	PT Menu	96
6-2-5	Objects Menu	112
6-2-6	Screen Menu	117
6-2-7	Tools Menu	125
6-2-8	Window Menu	127
6-2-9	Help Menu	128
6-3	Toolbars	129
6-4	Object Functions	134
6-4-1	Selecting Object	134
6-4-2	Common Settings	135
6-4-3	Button Objects	137
6-4-4	Meter (1 to 3)	145
6-4-5	Meter (4 to 7)	147
6-4-6	Level Meter	148
6-4-7	Pipe	151
6-4-8	Lamp	154
6-4-9	Data Display Object	157
6-4-10	Draw Objects	159
6-4-11	Input Objects	165
6-4-12	Line Graph Objects	167
6-4-13	Data Log Objects	170
6-4-14	Alarm Objects	176
6-4-15	Fixed Objects	179
6-5	Macro Function	184
6-5-1	Macro Types	184
6-5-2	Editing Macro	185
6-5-3	Macro Operation	189
6-5-4	Error Messages	212
6-6	Control Block and Status Block	215
6-6-1	Control Block	215
6-6-2	Status Block	219
6-6-3	Settings	223
6-7	Internal Memory	224

Note This section uses color NP-series PTs to tell the NP-Designer functions.

6-1 User Interface

Basic Screen

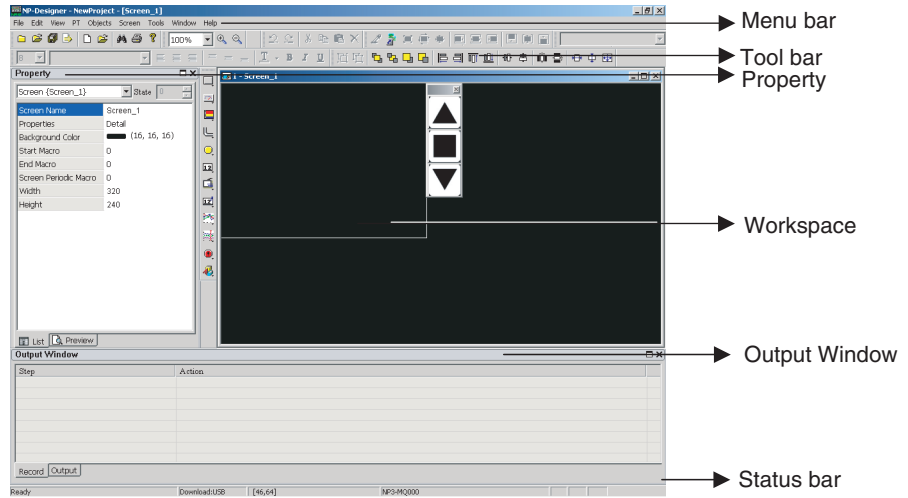

Property

Property List

The Property List sets the properties for each object. You can also refer to 6-4 Object Functions.

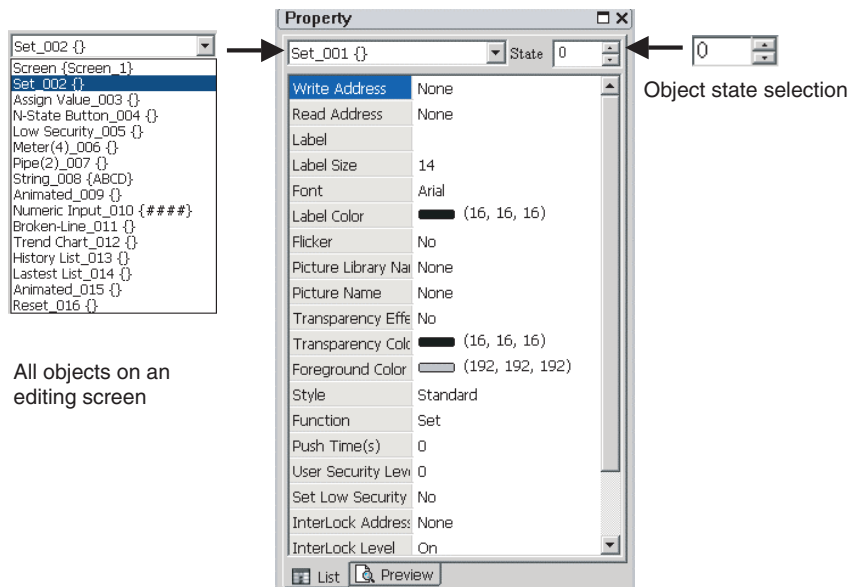

All objects on an editing screen

Screen editing preview



Output Window

The output window shows all user actions. If you use the validation function, this window also shows a message for each error. Click an error message to show the window that contains the error object.

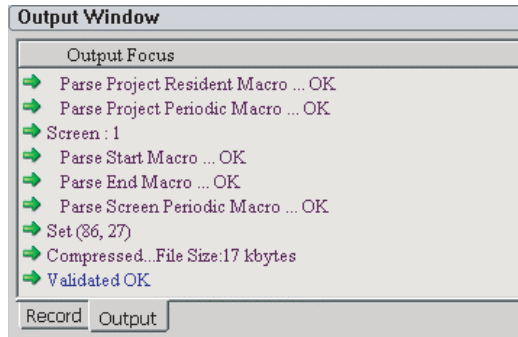

Status Bar

The status bar shows editing status.

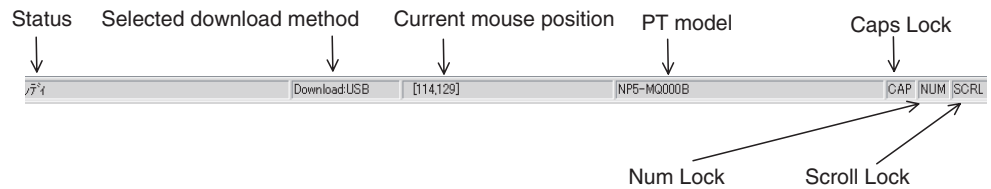

[Mouse position] @ position of selected object from upper left of window

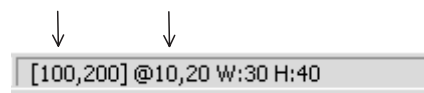

Width and height of the selected object

6-2 Menu

The NP-Designer has menus. You can use these menus to set the objects, pictures, graphs, macro programs, data blocks and create screen data to show them on NP-series PTs. This section tells you about the pull-down menu options.

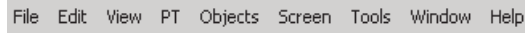

6-2-1 File Menu

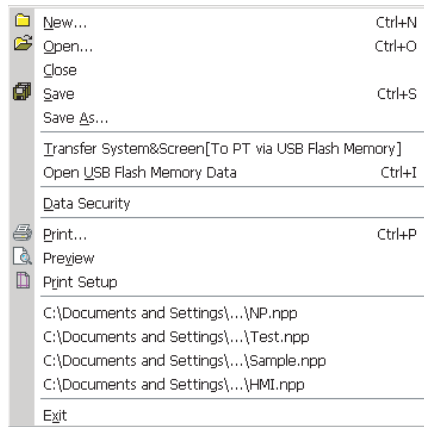

■ New

This command creates a new project.

To create a new project,

- select the **File Menu – New**,
- click the  icon in the toolbar or
- use the keyboard shortcut **Ctrl + N**.

1. If no project is open, you will see this dialog box.

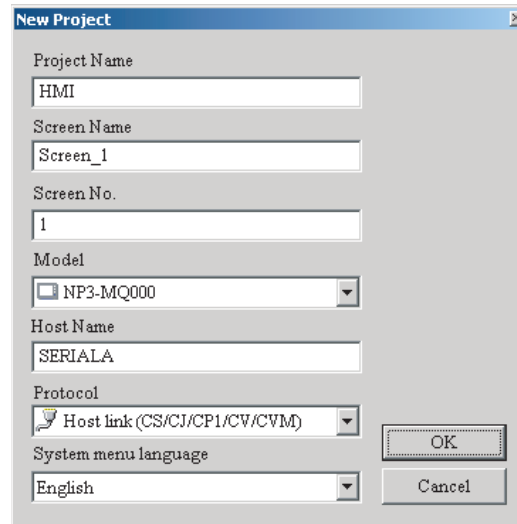

Reference The NP-Designer creates sample screen data when you select EJ1 from the Protocol option.

2. If other project files are open, you will see this dialog box.
 - Click the **Yes** Button to save the file.
 - Click the **No** Button to close and not save the file.
 - Click the **Cancel** Button to close the dialog box.

If you click the Yes or No Button, you will see the New Project Dialog Box again.

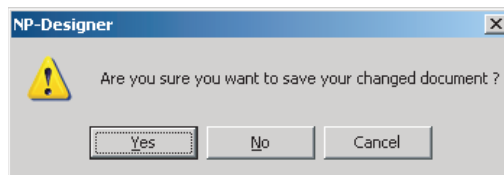

3. Input each item in the **New Project** Dialog Box. Then click the **OK** Button.

■ **Open**

This command opens a project file.

To open a project,

- select the **File** Menu – **Open**,
 - click the  icon in the toolbar or,
 - use the keyboard shortcut **Ctrl + O**.
1. If there are other project files and you did not save them, you will see a dialog box to save the files.
Click the **Yes** or **No** Button.
 2. You will see the **Open** dialog box. Select an npp file from this dialog box, and click the **Open** Button.

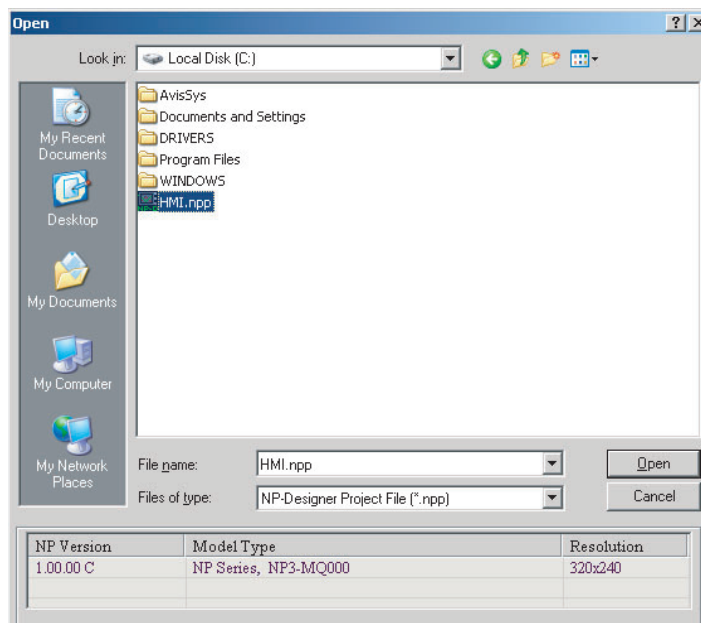

■ **Close**

This command closes a project file.

To close a project, select the **File** Menu – **Close**.

■ **Save**

This command saves a project file.

To save a project,

- select the **File** Menu – **Save**,
- click the  icon in the toolbar or
- use the keyboard shortcut **Ctrl + S**.

If the project is a new file, you will see the **Save As** Dialog Box. If the project is not a new file, the saving operation starts immediately.

■ Save As

This command saves a file with a new file name.

- 1,2,3...**
1. Select the **File** Menu – **Save As**. You will see **Save As** Dialog Box.
 2. Input a project name with a file extension of npp.
 3. Click the **Save** Button.

The NP-Designer shows this dialog automatically if you save a project file for the first time when you use **Save As** or **Save** command.

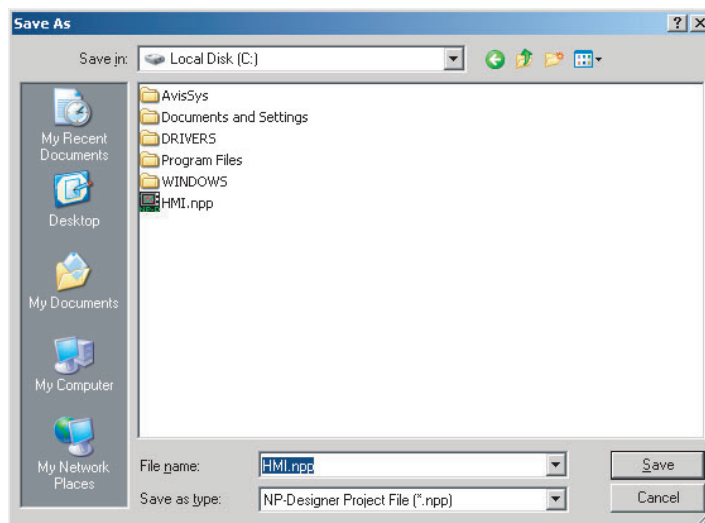

■ Transfer System&Screen [To PT via USB Flash Memory]

This function transfers screen data to a PT via USB flash memory.

- 1,2,3... 1. Select **File** Menu – **Transfer System&Screen [To PT via USB Flash Memory]**. You will see the **Browse for Folder** Dialog Box.

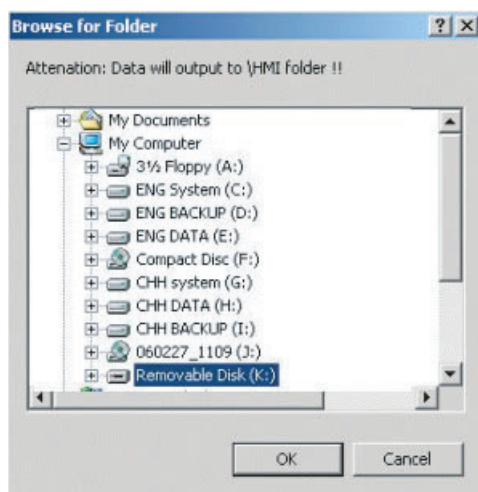

2. Specify the destination to copy the screen to a USB flash memory. You can insert this USB flash memory into an NP-series PT to transfer the screen data to the NP-series PT. For details, refer to 3-9 Using USB Flash Memory.

■ **Open USB Flash Memory Data**

This command opens USB flash memory data.

To open USB flash memory data,

- select the **File** Menu – **Open USB Flash Memory Data** or
- use the keyboard shortcut **Ctrl + I**.

- 1,2,3... 1. The users can move the screen data saved in the flash memory into USB flash memory through folder manager.
2. If you use the **Open USB Flash Memory Data** function, you will see the **Browse For Folder** Dialog Box.
3. You can open the screen data, and edit the data.

■ **Data Security**

This command enables and disables the data security function.

To enable or disable the data security function, select the **File** Menu – **Data Security**.

When the data security function is enabled, you will see the symbol adjacent to the [Data Security] command and a dialog box. This dialog box tells that you must use a password to open the npp file.

To set the password, select **PT** Menu and set it in the **PT Setting** Dialog Box.

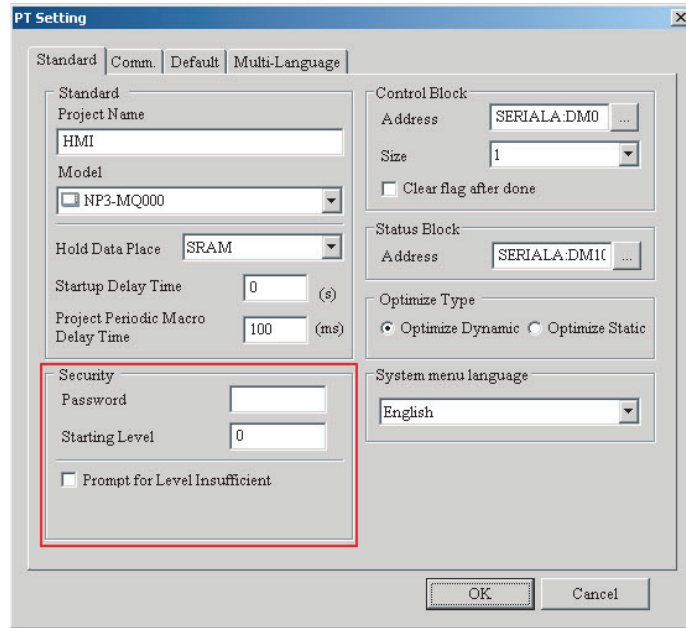

■ **Print**

This command prints screen data.

To print screen data,

- select the **File** Menu – **Print**,
- click the  icon in the toolbar or
- use the keyboard shortcut **Ctrl + P**

■ **Preview**

This command shows a preview of the printed image.

To see a preview of the screen, select the **File** Menu – **Print Preview**.

■ **Print Setup**

This command sets the properties, print range and the number of copies.

To set print settings, select the **File** Menu – **Print Setup**.

■ **Last Used Files**

The **File** menu shows a list of the last four used files.

To open these files, select a file name from the **File** Menu.

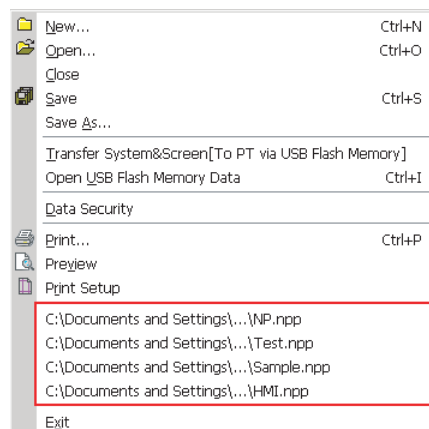









■ Exit

This command exits the NP-Designer.

To exit a project file, select the **File** Menu – **Exit**.

6-2-2 Edit Menu

	Undo	Ctrl+Z
	Redo	Ctrl+Y
	Cut	Ctrl+X
	Copy	Ctrl+C
	Paste	Ctrl+V
	Delete	Del
	Select All	Ctrl+A
	Find	Ctrl+F
	Replace	Ctrl+H
	Replace Host Unit No.	
	Group	
	Ungroup	
	Edit Nodes	
	Order	▶
	Align	▶
	Make Same Size	▶
	Text Process	▶
	Repeat	

■ Undo

This command undoes the last action shown in the output window log. Operations on properties that are not shown in the output window log are not undone. To undo the operation,

- select the **Edit** Menu – **Undo**,
- click the  icon in the toolbar or
- use the keyboard shortcut **Ctrl + Z**.

■ Redo

This command redoes the undo action. The output window shows all actions. To redo the operation,

- select the **Edit** Menu – **Redo**,
- click the  icon in the toolbar or
- use the keyboard shortcut **Ctrl + Y**.

■ Cut

This command deletes the selected object, and save it in clipboard to paste to other position.

To cut an object,

- select the **Edit** Menu – **Cut**,
- click the  icon in the toolbar or
- use the keyboard shortcut **Ctrl + X**.

■ Copy

This command copies the selected object to the clipboard.

To copy an object,

- select the **Edit** Menu – **Copy**,

- click the  icon in the toolbar or
- use the keyboard shortcut **Ctrl + C**.

■ Paste

This command pastes an object in the clipboard.

To paste an object,

- select the **Edit Menu – Paste**,
- click the  icon in the toolbar or
- use the keyboard shortcut **Ctrl + V**.

■ Delete

This command deletes the selected object.

To delete an object,

- select the **Edit Menu – Delete** or
- use the keyboard shortcut **Del**.

■ Select All

This command selects all objects. When you select all objects, the NP-Designer uses the base object to align or resize. The base object has blue marks.

To delete all objects,

- select the **Edit Menu – Select All** or
- use the keyboard shortcut **Ctrl + A**.

■ Find

This command uses conditions to find labels or addresses.

To show the **Find** Dialog Box,

- select the **Edit Menu – Find** or
- use the keyboard shortcut **Ctrl + F**.

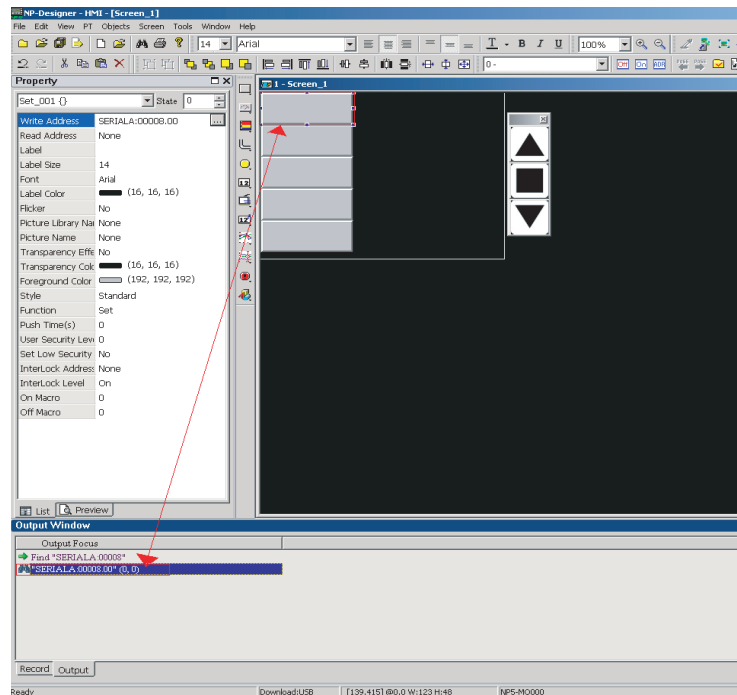

Find Dialog Box

Find What	Enter the label or address that you look for.	
Options	Current Screen	Examines the current screen only and finds the label or address that you look for.
	All Screen	Examines all screens and finds the label or address that you look for.
Type	Label	Finds the label that you enter.
	Read Address	Finds the read address that you enter.
	Write Address	Finds the write address that you enter.
	All Address	Finds all read addresses and write addresses that you enter.
Match whole word only	Finds only the labels or addresses that you entered. If you do not select the [Match whole word only] option, it finds all contents that include the labels or addresses that you entered.	
Support Multi-Language Finding	Finds all multi-language contents that include the labels or addresses you entered. You can use the [Support Multi-Language Finding] option when you find labels.	

■ **Replace**

This command replaces labels, read addresses and write addresses in the current screen or all screens. The replacement data type can be Bit, Word or Double Word. You can change the data type only for read addresses and write addresses.

To show the Replace Dialog Box,

- select the **File** Menu – **Replace** or
- use the keyboard shortcut **Ctrl + H**.

Replace Dialog Box

Find What	Enter a label or address that you look for.	
Replace With	Enter a label or address that you replace with.	

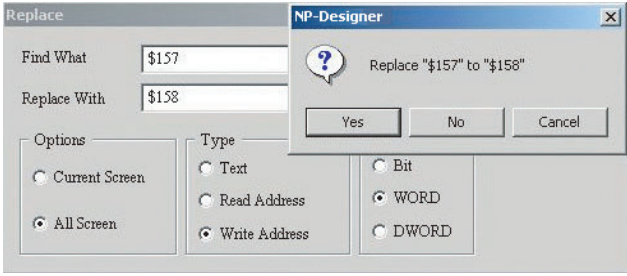
Replace Dialog Box		
Options	Current Screen	Examines the current screen only to find the label or address that you look for and replaces it.
	All Screen	Examines all screens to find the label or address that you look for and replaces it.
Type	Label	Finds and replaces the label that you entered.
	Read Address	Finds and replaces the read address that you entered.
	Write Address	Finds and replaces the write address that you entered.
Data Type	Bit	Selects Bit, Word or Double Word.
	WORD	
	DWORD	
Replace	Replaces the label or address that you entered and finds the subsequent one. For example, to replace the write address \$157 with \$158, enter \$157 in Find What field and \$158 in Replace With field. Click Replace Button. NP-Designer will find the address. Click Yes Button to replace the address.	
		
Replace All	Replaces the label or address automatically with all contents that you entered.	

■ **Replace Host Unit No.**

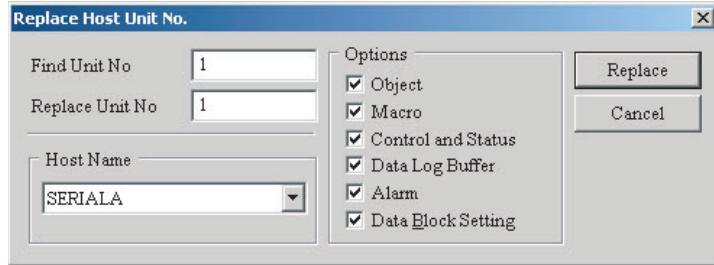
Replace Host Unit No. Dialog Box	
	
Find Unit No	Sets the unit number to be replaced.
Replace Unit No	Sets the host number for after replacement.
Host Name	Specifies the host name.
Option	Selects the items for replacement. Hosts of the checked items will be replaced.

■ **Group**

This command groups the selected objects. When you group two or more objects, they will become one unit. Thus, when you move or change the objects, you will move or change them together. You cannot make grouped objects and other object a group.

To group objects,

- select the **File** Menu – **Group**

- click the  icon in the toolbar, or
- use the keyboard shortcut Ctrl + G.

■ **Ungroup**

This command ungroups selected objects.

To group objects,

- select the **File Menu – Ungroup**
- click the  icon in the toolbar, or
- use the keyboard shortcut Ctrl + U.

■ **Edit Nodes**

This command edits, adds or removes the nodes of Polygon objects to change their shapes.

To show the nodes of fitted objects, select the **Edit Menu – Edit Nodes**.

To edit, add or removes nodes, follow the procedure below.

1. Editing Nodes

- 1,2,3...**
1. Move the cursor above the node. When the cursor changes to , drag the cursor to the new position for the node.
 2. Click the right mouse button to close the edit mode for nodes.

2. Adding Nodes

- 1,2,3...**
1. Click the Ctrl Key and move the cursor above the border of the object. When the shape changes to , left-click the position on the border where you add the node.
 2. Click the right mouse button to close the edit mode for nodes.

3. Removing Nodes

- 1,2,3...**
1. Click the Ctrl Key and move the cursor above the node you delete. When the shape changes to , left- click the node.
 2. Click the right mouse button to close the edit mode for nodes.





■ **Order**

This command changes the stacking order of the selected object.

To change the order,

- select each command from the **Edit Menu – Order** or
- click the order icons in the toolbar

The Order icons include:

	Bring to Top	Moves the selected object to the front.
	Send to Bottom	Moves the selected object to the behind.
	Bring Forward	Moves the selected object one step near the front.
	Send Backward	Moves the selected object one step to the behind.









■ **Align**

This command aligns the objects. You can use this command only when you select more than one object. The NP-Designer refers to the base object to align the objects.

To align the objects,

- select each command from the **Edit Menu – Align** or
- click the align icons in the toolbar.

The Align icons include:



	Align Left	Aligns the selected objects to the left side of the base object.
	Align Right	Aligns the selected objects to the right side of the base object.
	Align Top	Aligns the selected objects to the top of the base object.
	Align Bottom	Aligns the selected objects to the bottom of the base object.
	Align Vert. Center	Aligns the objects to the vertical center of the selected objects.
	Align Horiz. Center	Aligns the objects to the horizontal center of the selected objects.
	Across Space Evenly	Horizontally aligns all objects to the equal distances from all objects.
	Down Space Evenly	Vertically aligns all objects to the equal distances from all objects.

■ **Make Same Size**

This command makes the object to be the same size. The users must select one object first as reference object, and then select other objects.

To use this command,

- select each command from the **Edit Menu – Make Same Size** or
- click the make same size icons in the toolbar.

	Make Same Width	Makes the same width.
	Make Same Height	Makes the same height.
	Both	Makes the same width and height.



■ **Text Process**





Text Alignment

To align the text,

- select each command from the **Edit – Text Process** or
- click the text process icons in the toolbar.

The text alignment icons include:

	Text Align Left	Aligns the selected text to the left end of the object.
	Text Align Horiz. Center	Aligns the horizontal center of the object.

	Text Align Right	Aligns the selected text to the right end of the object.
	Text Align Top	Aligns the selected text to the top of the object.
	Text Align Vert. Center	Aligns the vertical center of the object.
	Text Align Bottom	Aligns the selected text to the bottom of the object.
	Add Underline	Adds the line below the selected text.

Import Text

This command imports the text from Text Library.

To show the **Text Library** Dialog Box, select the **PT Menu – Text Library**.

If you select the **Use Text Library Edit Font** option in the **Import Text** Dialog Box, the imported text shows in the font of Text Library. For details on the Text Library settings, refer to *Text Library* of **6-2-4 PT Menu**.

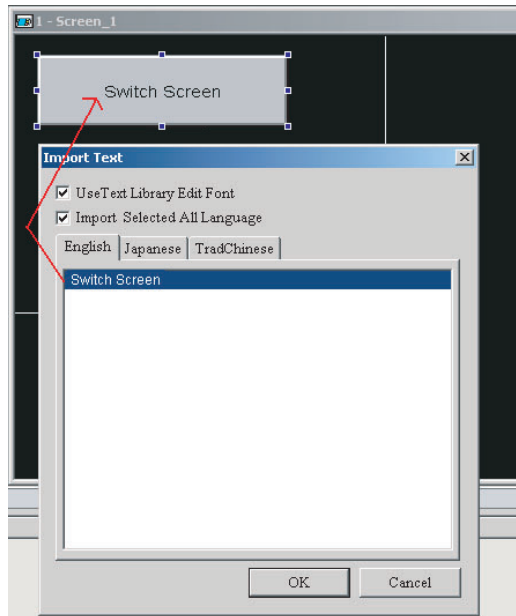

■ **Repeat**

This command multiplies the selected objects horizontally or vertically. To show the Repeat Dialog Box.

- select the Edit Menu – Repeat, or

- use the keyboard shortcut Ctrl + W.

Repeat Dialog Box

Number of Copies (Columns/Rows)	Sets the horizontal and vertical quantities. The quantities include the source object.
Space (Horizontal/Vertical)	Sets the horizontal and vertical spacing between objects in dot unit.
X-Direction/Y-Direction	Selects one of check boxes to increase or decrease the address.
Offset Address	Sets the offset value for addresses added when objects are repeated to between -10,000 and 10,000.

Repeat Example:
Step 1

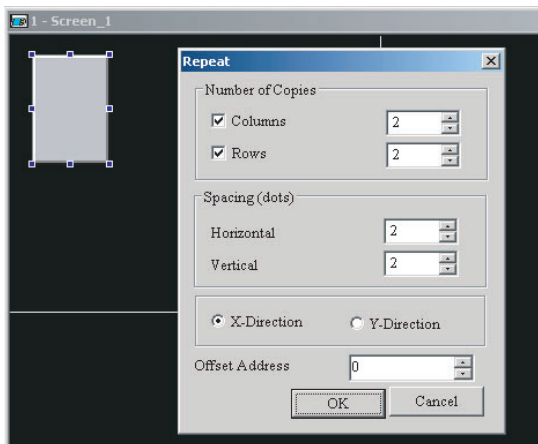

Step 2

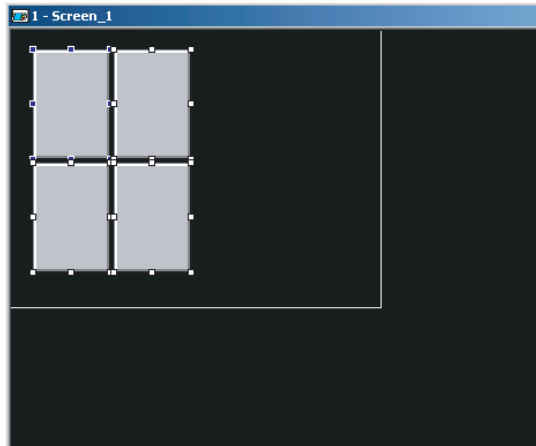

6-2-3 View Menu

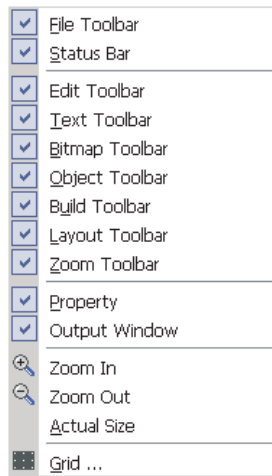

■ **Toolbar, Property and Output Window**

These commands show or hide the Toolbar, Property or Output Window. To show or hide, select each command.

■ **Grid**

This function aligns the objects easily and accurately. You can set the distance (spacing) between the grid dots freely. To use this function, select **View Menu – Grid**.

Grid Settings Dialog Box		
Show Grid		Shows the grid dots on the screen.
Snap to Grid		Makes objects snap to the grid when you move them.
Spacing	Width	Sets the width to between 4 and 50.
	Height	Sets the height to between 4 and 50.

Example of Grid Display:

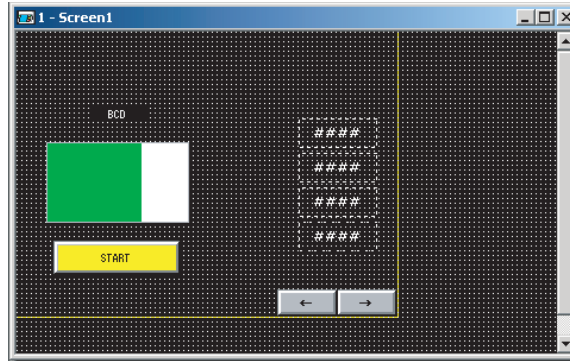

6-2-4 PT Menu

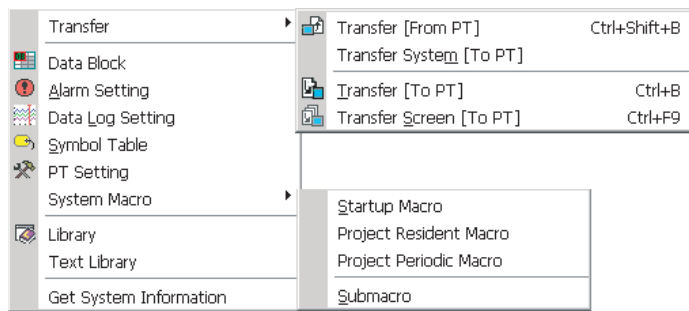

■ Transfer

Transfer [From PT]

This function transfers screen data from a PT to a computer.

- 1,2,3... 1. Select the PT Menu – Transfer [From PT] or use the keyboard shortcut **Ctrl + Shift + B**. You will see the password dialog box.

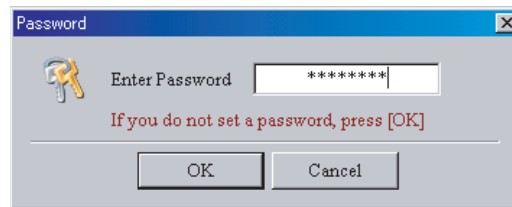

2. Input your password (The highest level password stored in the NP-Designer). You will see the **Save As** Dialog Box.
 3. Input the project file name. Click the **OK** Button. The transfer will start.

When the progress bar shows 100%, the transfer is completed. Then the uploaded screen data will be open. The progress bar shows the progress during the transfer. You can click the **Stop** Button to stop the transfer.



Note When you transfer the screen data, you cannot upload the settings made with the PT system menu.

Transfer System [To PT]

This function transfers the system or adds functions to a PT

To transfer the system to the PT, select the **PT Menu – Transfer – Transfer System [To PT]**.

Transfer [To PT]

This function transfers the screen data to the PT.

To transfer the screen data to the PT,

- select the **PT Menu – Transfer [To PT]**,
- click the  icon in the toolbar or
- use the keyboard shortcut **Ctrl + B**.

The progress bar shows the progress of transfer.

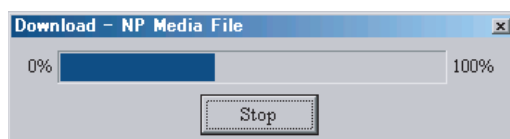

If you cannot connect the computer to the PT, you will see these error messages.



The download interface can be USB or RS-232 when you use a cable to transfer the screen data.

To set the download interface,

1,2,3...

1. Select the **Tools Menu – Option**
2. Set the interface in the **Transfer Setting** Field of the **Option** Dialog Box.

Transfer Screen [To PT]

This function transfers only screens to a PT.

To use this function,

- select the **PT Menu – Transfer Screen [To PT]**,
- click the  icon in the toolbar or
- use the keyboard shortcut **Ctrl + F9**.

■ **Transfer System [To PT via USB Flash Memory]**

This function transfers the systems from a computer to a PT via USB flash memory. NP-Designer shows this menu only when a project is closed.

To use this function, select the **PT Menu - Transfer System [To PT via USB Flash Memory]** when a project is closed.

**Precautions
for Correct Use**

Always ensure that communication settings are correct before transfer. If communication settings are incorrect, the touch reaction may be slower.

■ Data Block

Data blocks (recipes) make it possible to read/write values to memory areas of PLCs. To use the data block function, you must make settings with the **Data Block Setting** Dialog Box and control from the control block.

To show the **Data Block Setting** Dialog Box, select the **PT Menu – Data Block**.

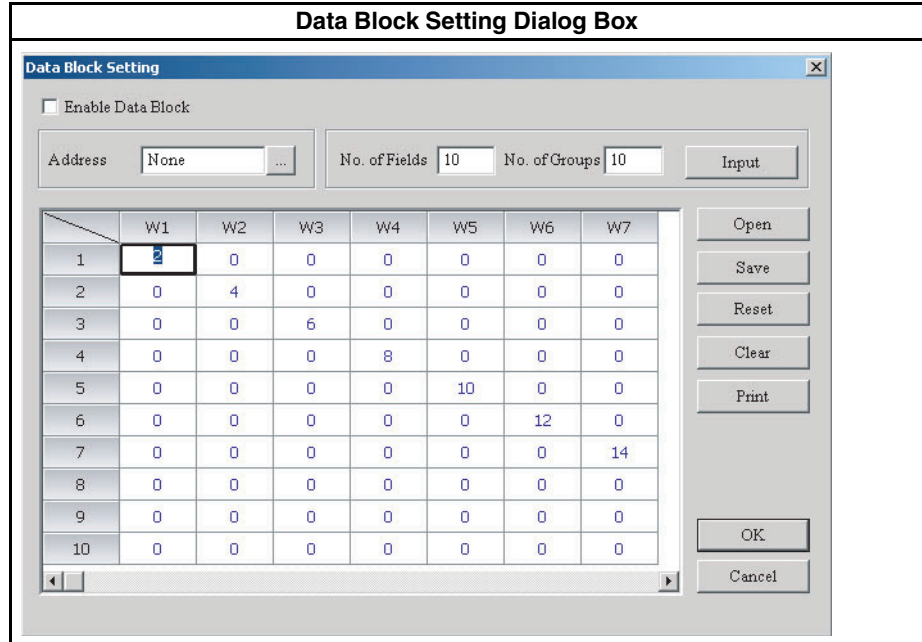

Enable Data Block	This option enables or disables the data block function. To disable the data block function, deselect this option.
Address	This option can input the starting address. Click the <input type="button" value="..."/> Button to show the address input dialog box.
No. of Fields	This option can set the data block size to 1 word or more.
No. of Groups	This option can set the number of groups to 1 or more.
Input	You can edit the data block data after you set the No. of Fields and No. of groups of the data block. There is a limit in the memory size for data block. If you select the SRAM in the Hold Data Place Field with the Data Block Setting Dialog Box, the memory size for data block is 64K. The total data block size must be less than 64K. (No. of Fields x No. of groups must be less than 64 X 1024)

Data Block Setting Dialog Box	
Input	
Open	You can open the data block data. The data block data you opened do not contain the starting address.
Save	You can save the edited data block data to a file. When the NP-Designer saves the data block file, it will not save the starting address.
Reset	You can delete all related data block setting and input data block data.
Clear	You can clear all input data block to 0.
Print	You can print all data block data on the current screen.
OK	You can save the set data block data.
Cancel	You can discard the changes and close the Data Block Setup Dialog box.

■ Alarm Setting

The alarm function shows a message when the registered address fits the specified conditions. To use this alarm function, you must make settings with the **Alarm Setting** Dialog Box and an alarm object. For details on alarm object settings, refer to 6-4 *Object Functions*.

To show the **Alarm Setting** Dialog Box, select the **PT Menu – Alarm Setting**.

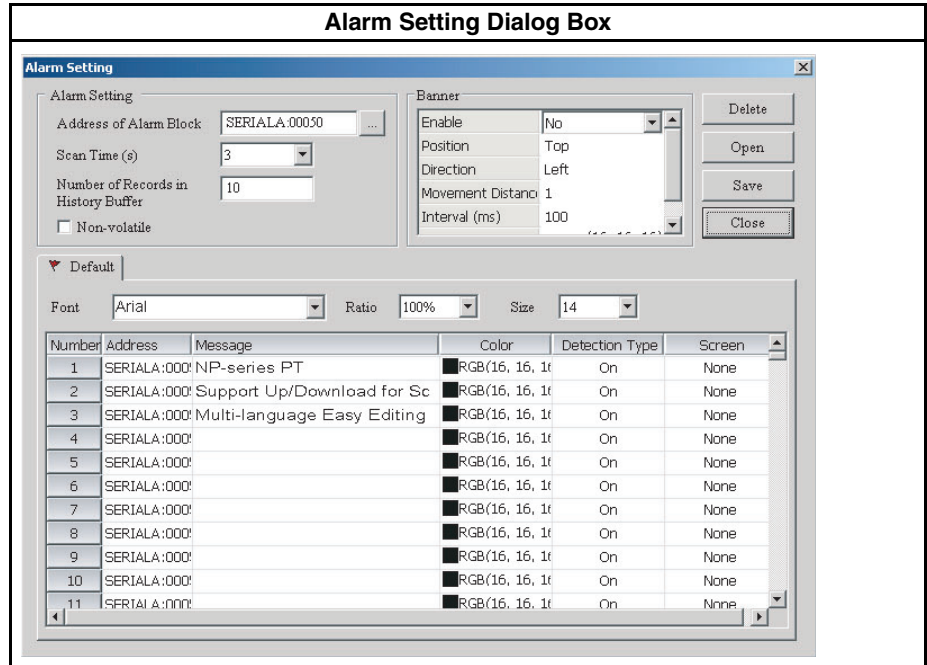

Alarm Setting	Address of Alarm Block	This option can set the alarm starting address. You can set the address to a minimum of 512 alarms, 32 Words.							
	Scan Time (s)	This option can set the time interval to monitor. The unit is second.							
	Number of Records in History Buffer	This option can set the number of occurred alarms to record. When the number of records becomes more than the set value, it will delete the first record and insert the new record into the last address.							
	Non-volatile	You can select this option to save data in the SRAM when the power supply is cut. The SRAM can save a maximum of 8K bytes of alarm data. (The power of SRAM is battery when the power supply is cut.)							
	Property	<p>The Alarm Setting Dialog Box also supports the multi-language function. There are three languages in the above example. Click each tab to edit the message.</p> <table border="1"> <tr> <td>Message</td> <td>This option can input messages that alarm objects show when alarms occur.</td> </tr> <tr> <td>Color</td> <td>This option can set colors that alarm objects show when alarms occur.</td> </tr> <tr> <td>Detection Type</td> <td>This option can set the alarm detection condition. You can set it to ON or OFF.</td> </tr> <tr> <td>Screen</td> <td>This option can set the screens that the PT shows when alarms occur.</td> </tr> </table>	Message	This option can input messages that alarm objects show when alarms occur.	Color	This option can set colors that alarm objects show when alarms occur.	Detection Type	This option can set the alarm detection condition. You can set it to ON or OFF.	Screen
Message	This option can input messages that alarm objects show when alarms occur.								
Color	This option can set colors that alarm objects show when alarms occur.								
Detection Type	This option can set the alarm detection condition. You can set it to ON or OFF.								
Screen	This option can set the screens that the PT shows when alarms occur.								

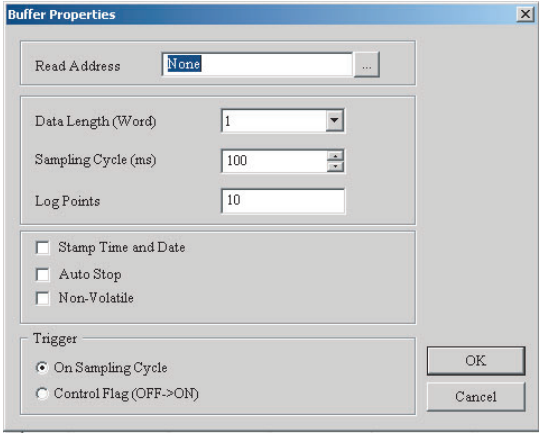
Data Log Setting Dialog Box	
Append	<p>You can input necessary items and add a maximum of 12 data logs.</p> 
Read Address	This option can set the starting address that samples the data log data.
Data Length	<p>This option can set the word length for sampling. The range is between 1 and 13 continuous words. You can sample a maximum of 13 continuous words.</p> <p>Example</p> <p>When the Data Length is 6, the PT samples continuous 6 words (\$M100, \$M101,.....,\$M105). When the Log Points is 100, the PT samples 6 words x 100 = 600 each time.</p>
Sampling Cycle	This option can set the sampling cycle time to read the address (The length of time to read the address one time). If you set the Trigger option to the Control Flag (OFF→ON) , the Sampling Cycle option is disabled. The range of the sampling cycle time is between 0 and 86400000 ms.
Log Points	This option can set the log points.
Trigger	<p>You can select one of these logging timing.</p> <ul style="list-style-type: none"> • On Sampling Cycle The PT logs on the sampling cycle timing set in the Sampling Cycle Field. • Control Flag (OFF→ON) The PT logs when the control flag turns from OFF to ON.
Stamp Time and Date	You can select this option to record the time and date during sampling operation.
Auto Stop	<p>You can set whether to stop logging or not when the PT has the number of logs you set.</p> <ul style="list-style-type: none"> • Select this option to stop logging the data after the number of logs becomes the set value of Log Points option. • Deselect this option to delete the final log and insert the new record into the last address when the number of data logged is larger than the set value of the Log Points option.
Non-Volatile	You can select this option to save data in SRAM when the power supply is cut. The SRAM can save a maximum of 240K bytes of sampling data. (The power of SRAM is battery when the power supply is cut.)
OK	You can save the data and exit the Buffer Properties Dialog Box.
Cancel	You can discard the changes and exits the Buffer Properties Dialog Box.

Data Log Setting Dialog Box	
Delete	You can delete data logs.
Modify	You can change data logs.

■ **Symbol Table**

This function names addresses. For example, you can name [SERIALA:DM00100] [Symbol_A].

To show the **Symbol Table** Dialog Box, select the **PT Menu – Symbol Table**.

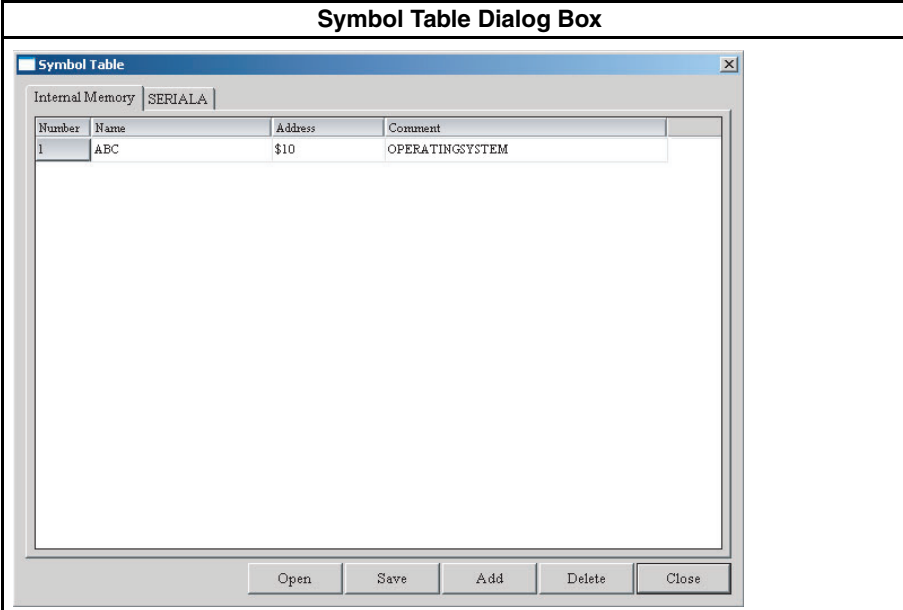
Symbol Table Dialog Box	
	
Open	You can open a tag file.
Save	You can save the settings made with the Symbol Table Dialog Box as a tag file.
Add	<p>You can add a symbol.</p> <ol style="list-style-type: none"> 1. Select the Internal Memory or SELEALA. (Host names are shown on the third or more tabs.) 2. Click the Add Button. <p>Do not add a symbol with only a number or with the same address.</p>
Delete	<p>You can delete the selected row.</p> <ol style="list-style-type: none"> 1. Use the mouse to select a row to delete. 2. Click the Delete Button. The selected row is deleted.
Close	You can discard the changes and exit the dialog box.

Reference

- If you do not input a name or address and click the Close Button, you will see a warning message.

■ **PT Setting**

PT Setting Dialog Box contains **Standard**, **Comm.**, **Default** and **Multi-language** Tab Pages. This section describes these tabs.

To show the **PT Setting** Dialog Box, select the **PT Menu – PT Setting**.

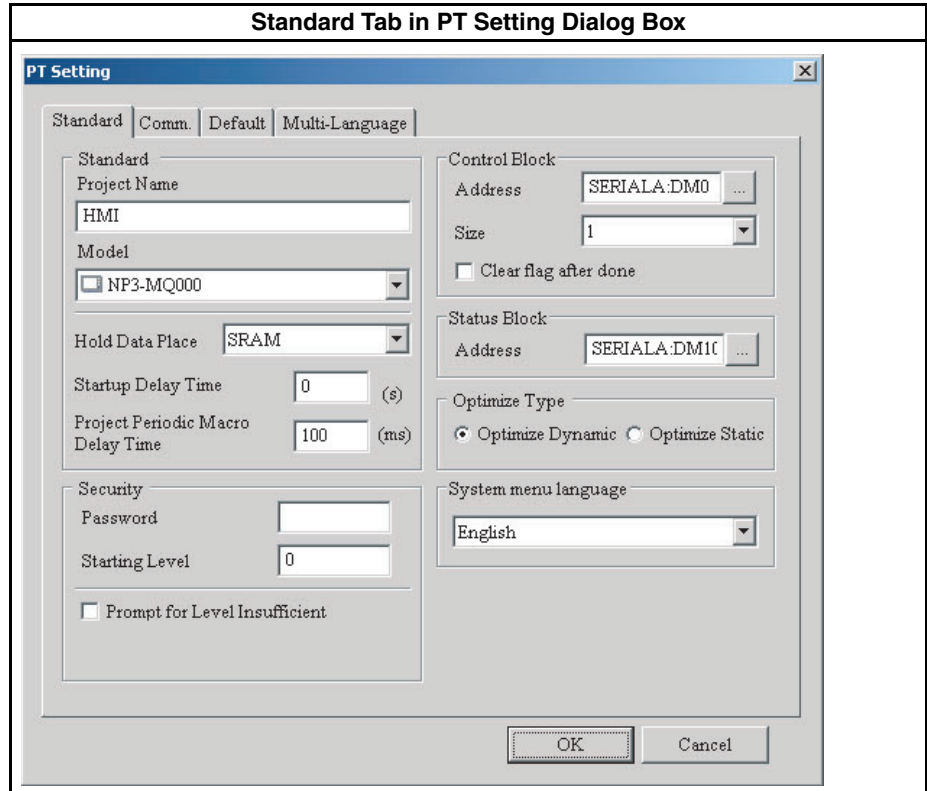

Project Name	This option can set the project name.
Model	This option can select a PT model you use.
Hold Data Place	This option can save the backup memory data in SRAM or USB flash memory.
Startup Delay Time	This option can set the delay time for the startup of the PT. The range is between 0 and 255 seconds.
Project Periodic Macro Delay Time	This option can set the interval time to use the project periodic macro. The range is between 100 and 65535ms.
Password	This option can set a highest level password. You can set this password with one-by-numeric. You use the password when you transfer a project file and open a file.
Starting Level	This option can set the starting level. There are 8 levels. The highest level is 7 and the lowest level is 0.
Prompt For Level Insufficient	You can select this option to show a mark on objects when the user level is lower than the levels of objects.
Address (Control Block)	This option can set the starting address of system control block. Refer to 6-6 Control Block and Status Block.
Size	This option can set the length of control block. When the control block size is 0, the control block function is disabled.
Clear flag after done	You can select this option to clear the address in the control block to 0 when an operation was completed in the control block.
Address (Status Block)	This option can set the starting address of system status block. Refer to 6-6 Control Block and Status Block.

Standard Tab in PT Setting Dialog Box		
Optimize Type	Optimize Dynamic	This option can optimize all objects that read addresses on the screen when the PT switches screens. Note When you select this function, all objects that read addresses on the screen will show incorrect values for a short time. All objects show correct values after optimization is completed.
	Optimize Static	This option can optimize all objects that read addresses on the screen during validation operation.
System Menu Language	This option can set a language for the System Menu.	

Communication Tab in PT Setting Dialog Box		
Add/Delete Controller Connection	Add	You can give a host name and sets a protocol. Some hosts cannot simultaneously communicate via 2 ports. For details, refer to 1-1 Supported Hosts in the Host Connection Manual.
	Delete	You can delete a host. You cannot delete the host No.1.
	Modify	You can change a host name and protocol.
Protocol Settings-1	PT Unit No.	This option can set the PT unit number. The range is between 0 and 255.
	Host Unit No.	This option can set the host unit number. If you do not do this setting, the host unit number will be the default setting. The range is between 0 and 255.
	Interface	This option can set the communication interface.
	Data Bits	You can select 7 Bits or 8 Bits.
	Stop Bits	You can select 1 Bit or 2 Bits.
	Baud rate	You can select 4800, 9600, 19200, 38400, 57600 or 115200. It is possible to enter the value directly. Maximum setting value cannot be more than 150000.
Parity	You can select None, Odd or Even.	

Communication Tab in PT Setting Dialog Box		
Protocol Settings-2	COM Port	This option can set the COM port that communicates with PT (COM1 or COM2).
	Password	A password is necessary for some PLCs before communication. You can set a password with one-byte numerics.
	Comm. Delay	This option can set the delay time before the host starts. The range is between 0 and 255 ms.
	Timeout	This option can set the communication timeout time when the PT communicates with the host. The range is between 20 and 65535ms.
	Retry Count	This option can set the retry counts. You will see a communication error dialog box if the number of times that the PT sends a command becomes the same as the retry counts. The range is between 0 and 255 times.
Optimize	You can select this option to optimize all read addresses of all related objects.	
Size Limit	You can select this option to keep the screen update speed when the PT reads continuous addresses. This function is available only when you select Optimize Type – Optimize Static in the Standard Tab .	
Communication Interrupt N times then cancel	You can select this option to stop the communication with the host after the communication interruption times becomes the same as the setting time. Thus, it is possible to hide the communication error dialog box on the PT screen when the communication error occurs after the PT retries. The range is between 1 and 255 times.	

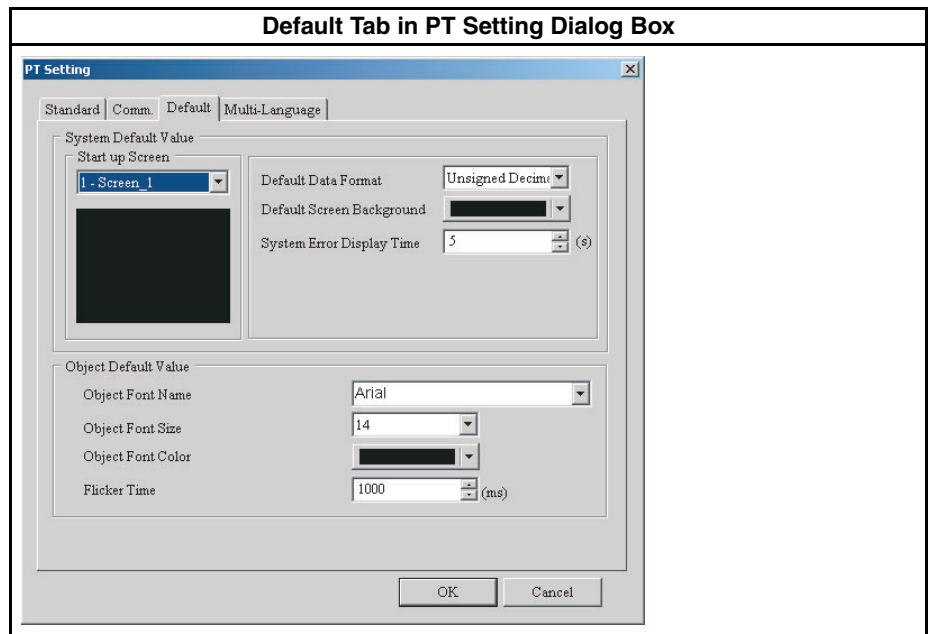

Default Tab in PT Setting Dialog Box		
System Default Value	Start up Screen	This option can set the first display screen when PT starts.
	Default Data Format	This option can set the default data format of objects.
	Default Screen Background	This option can set the default screen background color of a new screen.
	System Error Display Time	This option can set the display time of the system error message dialog box. The range is between 0 and 5 seconds. Note If you set 0, the PT does not show the system error message dialog box.
Object Default Value	Object Font Name	This option can set the default object font.
	Object Font Size	This option can set the default object font size.
	Object Font Color	This option can set the default object font color.
	Flicker Time	This option can set the default object flicker (blink) time.

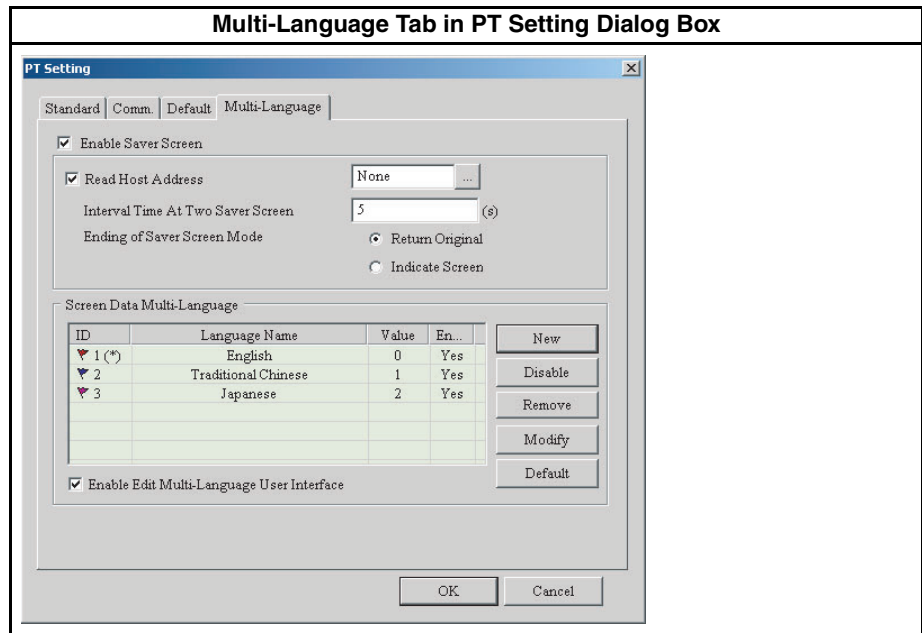

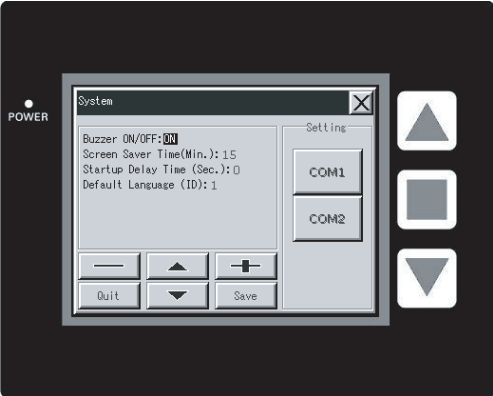
Multi-Language Tab in PT Setting Dialog Box	
Saver Screen	<p>For details on how to set the saver screens, refer to <i>6-2-6 Screen Menu</i>.</p>
Enable Saver Screen	<ul style="list-style-type: none"> You can select this option to use Edit Saver Screen function in Screen Maintenance option. You can deselect this option to not start the screen set with Edit Saver Screen function. After the set time elapsed, the PT does not show the saver screen and stops the backlight.
Read Host Address	<ul style="list-style-type: none"> You can select this option to enable the screen saver. When the user touches the PT screen, the screen saver function is disabled. <ul style="list-style-type: none"> When the setting value is 0: The PT disables the screen saver function. When the setting value is a non-zero value: The PT enables the screen saver function. You can deselect this option to start up the screen saver automatically when the Screen Saver Time set in the PT elapsed. When the user touches the PT screen, the screen saver function is disabled.
	
Interval Time At Two Saver Screen	<p>This option can set the interval time between two screen savers. The range is between 1 and 255 seconds.</p>
Ending of Saver Screen Mode	<p>Return Original: The screen goes back to the original screen when the screen saver starts.</p> <p>Indicate Screen: You can specify the screen to show after the screen saver ends.</p>

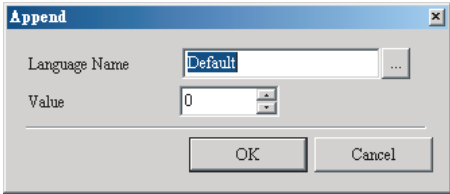
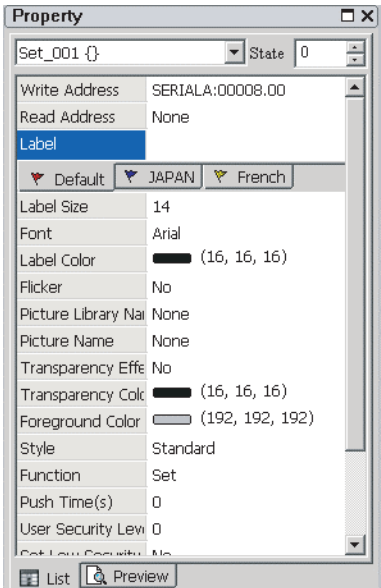
Multi-Language Tab in PT Setting Dialog Box		
Screen Data Multi-Language	New	<p>This option can add a maximum of 8 languages.</p>  <ul style="list-style-type: none"> • Enter the language name and value. The system will refer to the value. The range of the setting value is between 0 and 255. • To select the flag color on the language name tab, click the ... Button.
	Enable/Disable	You can set which languages are enabled or disabled when you download data to the PT.
	Remove	You can remove a language. There must be a minimum of one language for a project.
	Modify	You can change the language name and value.
	Default	Sets the default language when using more than one language.
	Enable Edit Multi-Language User Interface	<p>You can select this option to enable the multi-language user interface and view the multi-language display in the property list.</p> <p>See below example.</p> 

■ **System Macro**

There are Startup Macro, Project Resident Macro, Project Periodic Macro and Sub-macro.

For details, refer to *6-5 Macro Function*.





■ **Library**

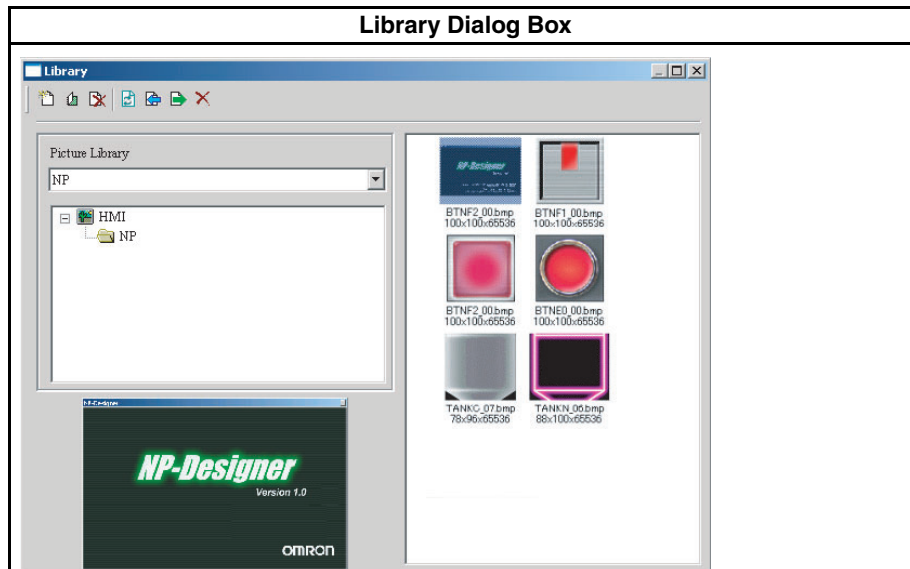

This function imports and saves many pictures to the Library.

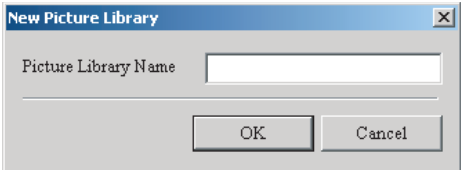
To show the **Library** Dialog Box, select the **PT** Menu – **Library**.

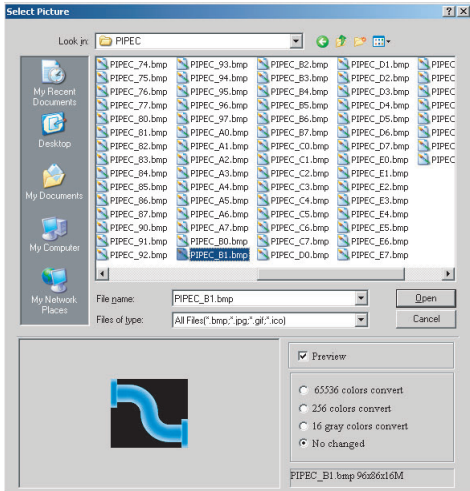

Click the Library option to browse all pictures saved in the Library. When one picture is selected, the preview window shows the picture. To show the selected picture in a real size, double left click on the picture.

 <p>New Library</p>	<p>This icon creates a new library. If you click this icon, the New Picture Library Dialog Box shows.</p> 
 <p>Open Library</p>	<p>This icon opens a library file (*.pib file).</p>
 <p>Delete Picture Library</p>	<p>This icon uninstalls the selected library. The library will go to the Recycle Bin.</p>
 <p>Update Picture Library</p>	<p>This icon updates the picture library.</p>

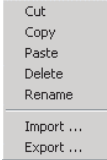
Library Dialog Box	
 Import Picture	<p>This icon imports pictures into the specified library. The formats of the pictures can be BMP, JPG, GIF (static) and ICO pictures.</p> <p>To import pictures,</p> <ol style="list-style-type: none"> 1. Click this icon. You will see the Select Picture Dialog Box. 2. Select pictures. 
 Export	<p>This icon exports pictures in BMP format from the library.</p>
 Delete Picture	<p>This icon deletes pictures in the library.</p>
Shortcut Menu	<p>To show the shortcut menu, right-click on the picture. The shortcut menu shows a list of commands related to library.</p> 

■ **Text Library**

This function enables you to input frequently used text into the Text Library. It is possible to select the text from the Text Library and enter them on the object.

To use the Text Library, select the **PT Menu – Text Library**.

Text Library Dialog Box

Add	You can add the text into the Text Library. You can input the text in different language, set each font and save them in the Text Library.
Delete	You can delete the input text in the Text Library.
Open	You can open and import the text or terms into the Text Library.
Save	You can save and export the text file.
Close	You can exit the Text Library Dialog Box.

Reference Do not use a text editor to edit txt files. If you do this, you cannot possibly open the txt files.

6-2-5 Objects Menu

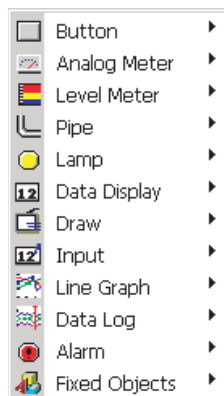

The NP-Designer has 12 types of objects and has many functions. The 12 types include button, analog meter, level meter, pipe, lamp, data display, graph display, input, curve, data log, alarm and fixed objects. For details on object properties, refer to *6-4 Object Functions*.

■ **Creating Object**

- 1,2,3... 1. Right-click the mouse in the workspace to select an object.

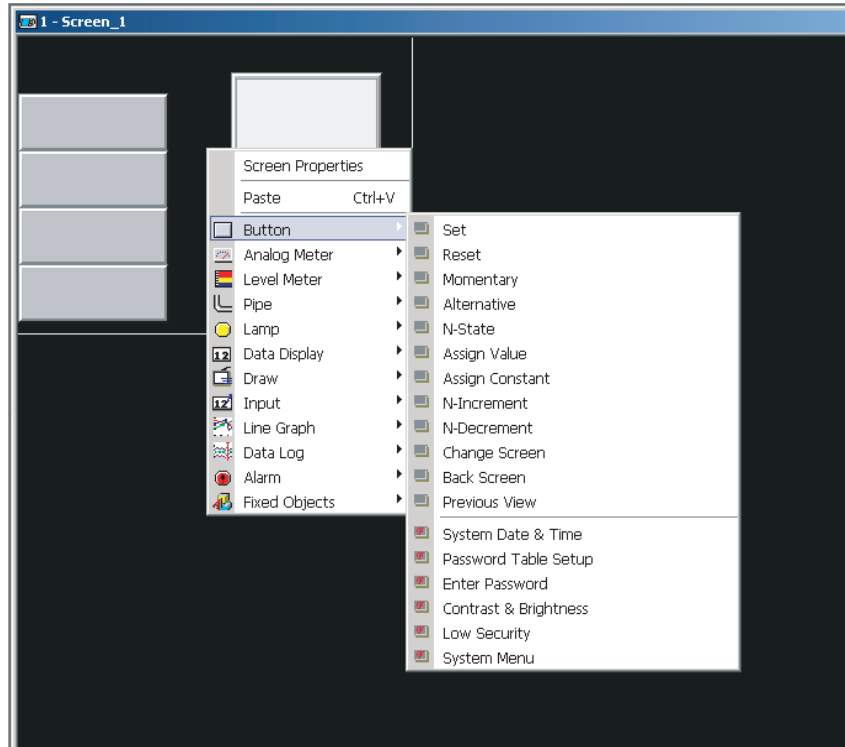

2. Hold down the left mouse button and drag the mouse cursor.

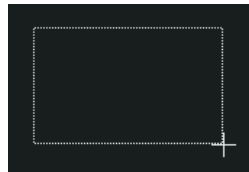

3. Release the left mouse button to create an object.

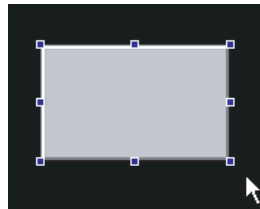

4. Set the object property.

■ **Moving Object**

- 1,2,3... 1. Move the mouse cursor above the object. The mouse cursor changes into a four-way arrow icon.

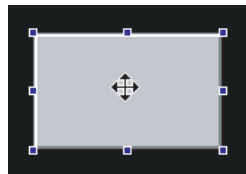

2. Hold down the left mouse button and move the mouse to move the object.

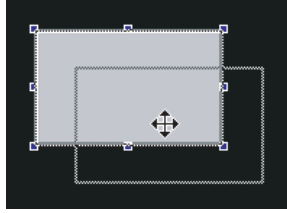

3. When the object is in the correct position, release the left mouse button.

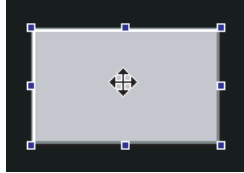

■ Changing Object Width

- 1,2,3...**
1. Move the mouse cursor to the edge of the object. The cursor will change the \leftrightarrow icon.

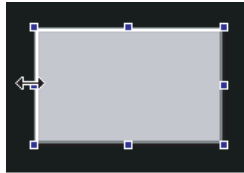

2. Hold down the left mouse button and move the mouse to change the object width.

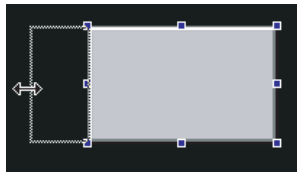

3. When the object width is correct, release the left mouse button.



■ Changing Object Height

- 1,2,3...**
1. Move the mouse cursor to the edge of the object. The cursor will change the \updownarrow icon.



2. Hold down the left mouse button and move the mouse to change the object height.

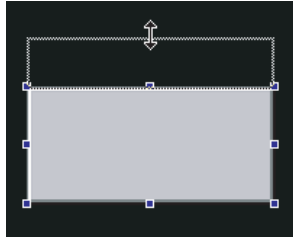

3. When the object height is correct, release the left mouse button.

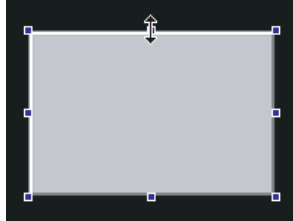

■ Changing Object Width and Height at the Same Time

- 1,2,3...
1. Move the mouse cursor to the edge of the object. The cursor will change the ↗ icon.

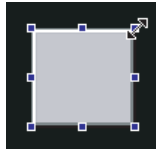

2. Hold down the left mouse button and move the mouse to change the object height and width.

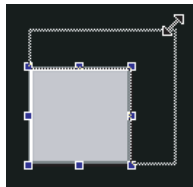

3. When the object height and width are correct, release the left mouse button.

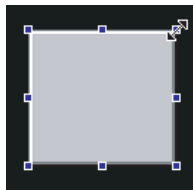

■ Inputting Characters

You can use one of these procedures to input characters.

- Move the mouse cursor in the **Label** field of the **Property** to make the cursor  shape.
- Select the object and click the space key.

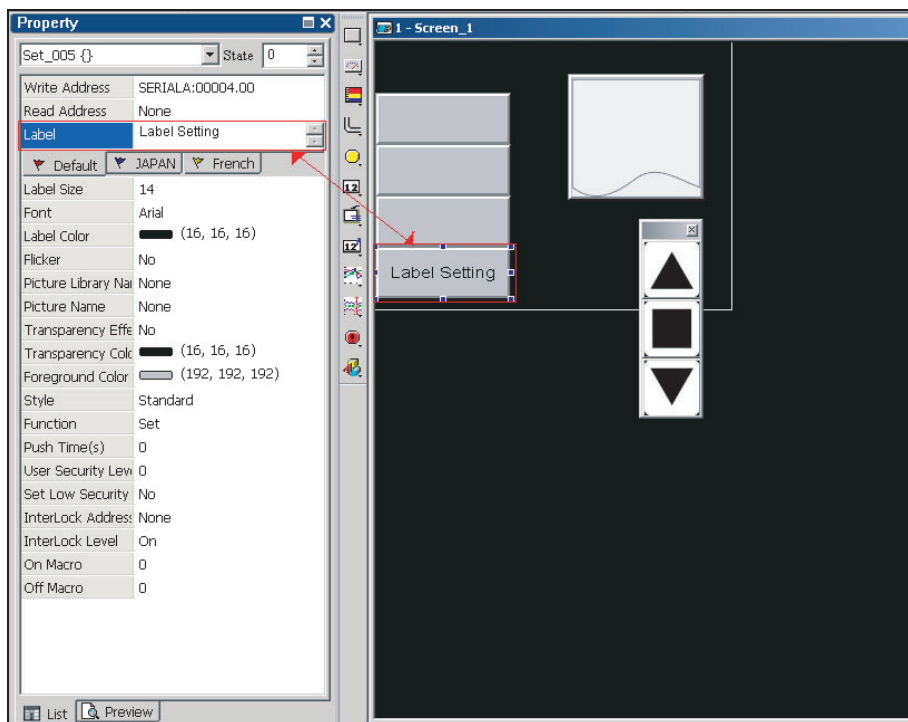

■ **Right-clicking the Mouse**

When you right-click the mouse, you will see different menus.

- Right-click in the toolbar

The Toolbars Display Setup Menu shows.

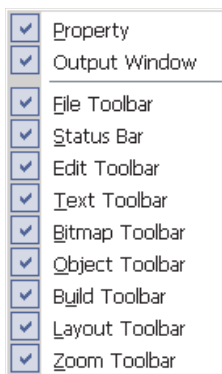

- Right-click on the workspace.

The Object Selection Menu shows.

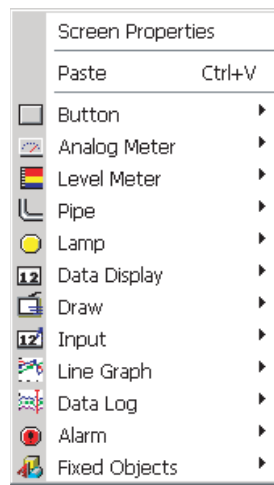

- Right-click on the object.

The Object Editing Menu shows.

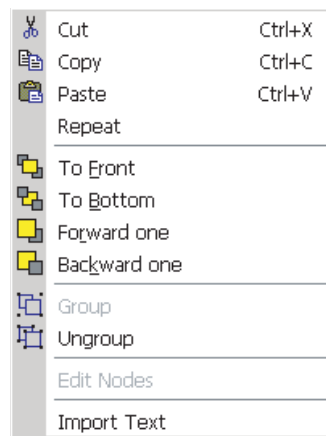

6-2-6 Screen Menu

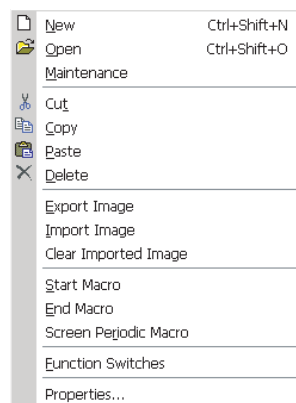

■ **New**

This function creates a new screen. Up to 1,000 screens can be created in one project.

To create a new screen,

- select the **Screen** Menu – **New**,

- click the  icon in the toolbar or
- use the keyboard shortcut **Ctrl + Shift + N**.

You can give a name and ID for the new screen.

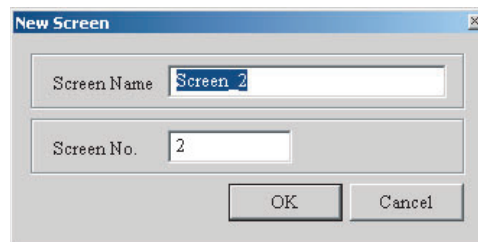

■ Open

This command opens a screen.

To open a screen,

- select the **Screen** Menu – **New**,
- click the  icon in the toolbar or
- use the keyboard shortcut **Ctrl + Shift + O**.

When you select this command, you can preview each screen in **Open Screen** Dialog Box.

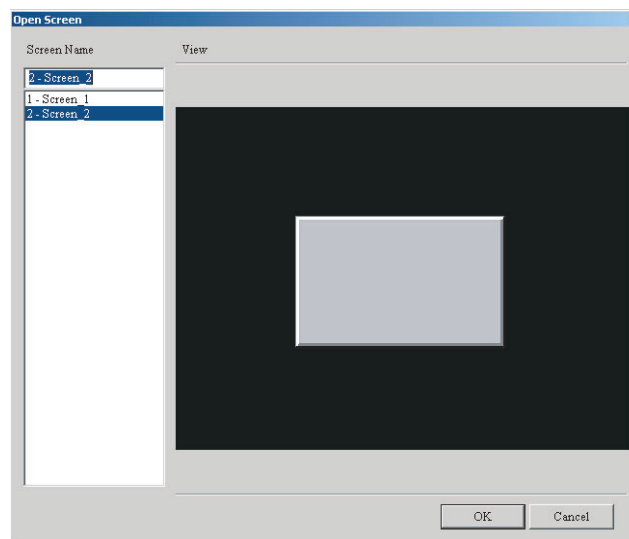

■ Maintenance

This function does screen maintenance. You can copy, paste, cut screens and specify saver screens. To set the saver screen settings, select the **PT** Menu – **PT Setting** – **Multi-Language** Tab Page. To select saver screens, do these procedures.

Selecting Saver Screens

- 1,2,3... 1. Select the **Maintenance** from the **Screen** Menu to open the **Screen maintenance** window.

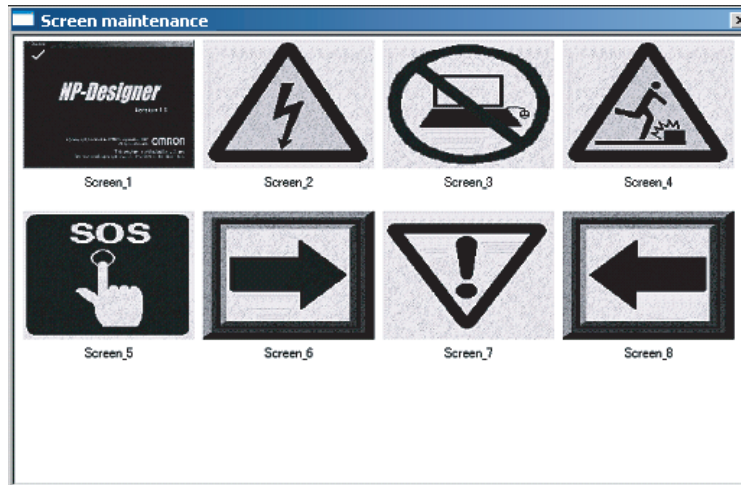

2. Right-click the mouse to select the **Edit Saver Screen** function.

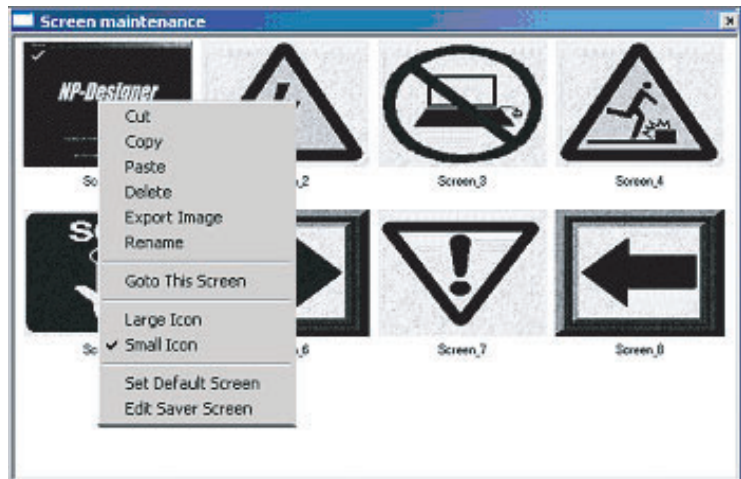

3. Drag the mouse to specify the saver screen.

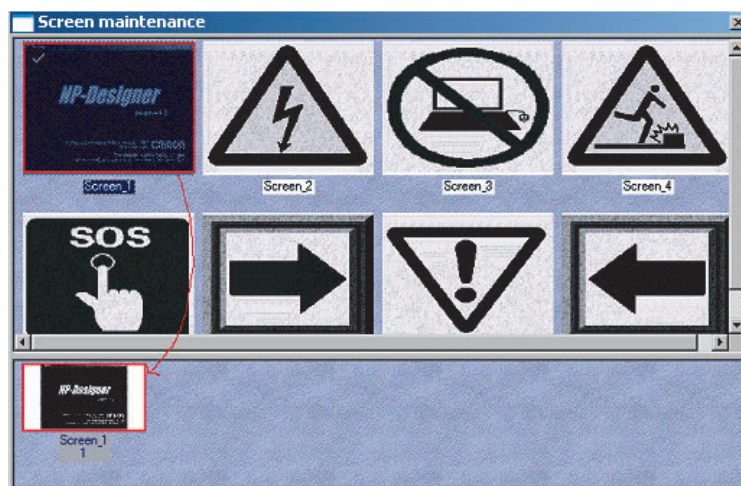

Deleting Saver Screens

Select a saver screen that you want to delete. Then press the [Delete] key.

■ Cut

This command cuts the full screen to paste it to clipboard.

To cut the full screen, select the **Screen** Menu – **Cut**.

Reference It is not possible to undo the cut operation. The cut command deletes the screen and its operation is the same as the delete command. But you can paste the screen to have the same screen. After you select the Cut command, you will see this dialog.

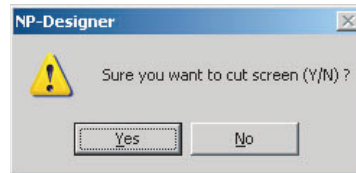

■ Copy

This command copies the full screen.

To copy the full screen, select the **Screen** Menu – **Copy**.

■ Paste

This command pastes a screen. All screen setting will be the same as source screen. The NP-Designer gives a screen name automatically.

To paste a screen, select the **Screen** Menu – **Paste**

■ Delete

This command deletes the current screen and objects.

To delete, select the **Screen** Menu – **Delete**.

Reference It is not possible to undo the delete operation. After you select the Delete command, you will see the dialog box below. Make sure that you select a correct screen before you delete.

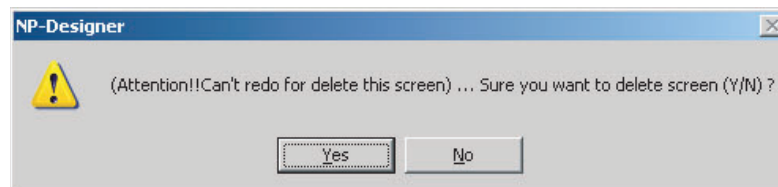

■ Export Image

This command exports a screen to image

To export,

- select the **Screen** Menu – **Export Image**, or
- click the  icon in the toolbar.

■ Import Image

This command imports an image to be the ground of the editing screen. You can import BMP, JPG, GIF and ICO.

To import, select the **Screen** Menu – **Import Image**.

■ Clear Imported Image

This command deletes an imported image.

To delete, select the **Screen** Menu – **Clear Imported Image**.

■ Start Macro

For details on how to use and edit, refer to *6-5 Macro Function*.

■ End Macro

For details on how to use and edit, refer to *6-5 Macro Function*.

■ Screen Periodic Macro

For details on how to use and edit, refer to *6-5 Macro Function*.

■ Function Switch

This function specifies functions for function switches used on screens of NP-series PTs.

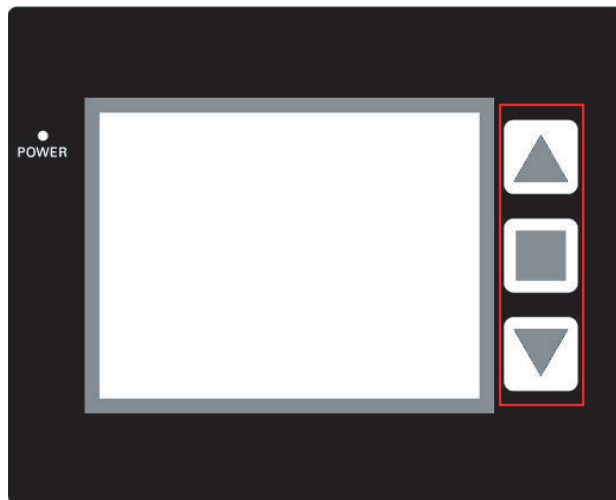
**Setting the Function Switch**

- 1,2,3...**
1. If the Function Switch Window is not on the screen, select the **Screen** Menu – **Function Switch**.
 2. Press a Function Switch. A menu shows.
 3. Click a function.

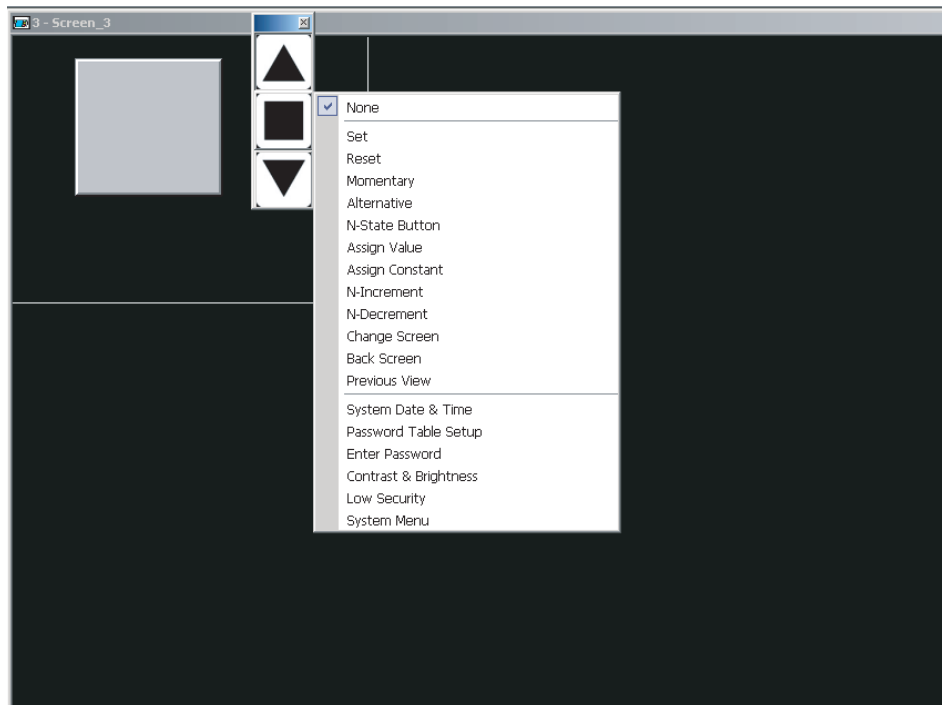

Reference

- The System Menu function is set by default. The function switches below have the System Menu function.

Model	Function Switch
Three Function Switches	Middle
Six Function Switches	F6

■ **Properties**



This function sets the properties of the current screen.

To set properties,

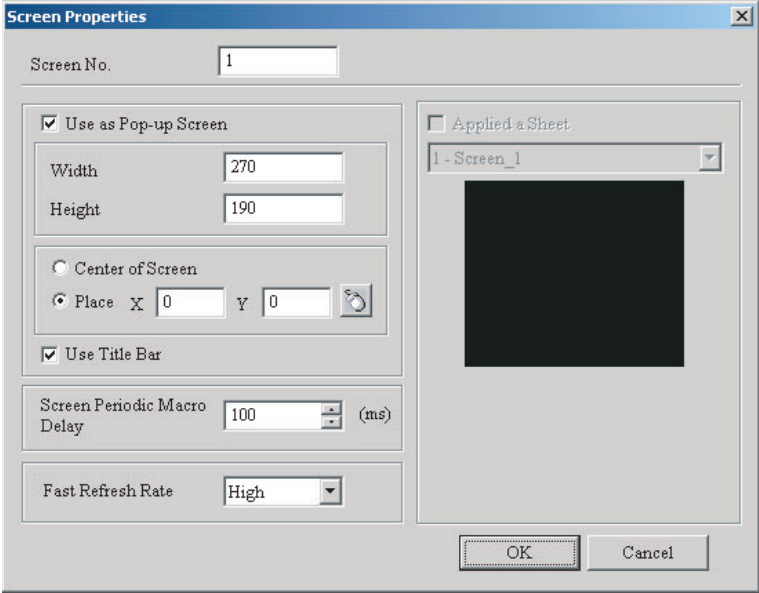

- select the **Screen** Menu – **Properties**.

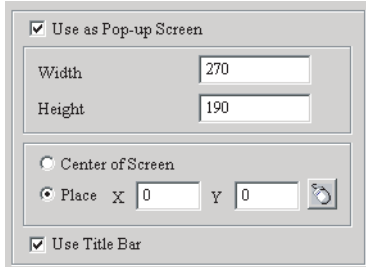
- select the **Details** of the **Properties** from the **List** Tab Page of the **Property**.

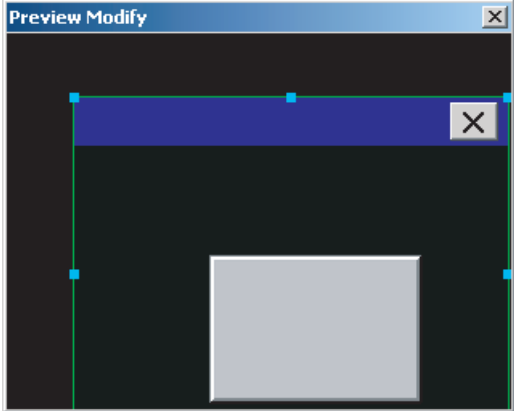
Screen Properties Dialog Box	
	
Screen No.	The range is between 1 and 65535. You cannot use the same number two times.

Screen Properties Dialog Box		
Pop-up Screen	Use as Pop-up screen	<p>A Pop-up screen shows on the current screens</p>  <p>The Pop-up screens are not closed even when the user switches base screens.</p>
	Width	This option can set the width of pop-up screen. The unit is dot. The minimum value is 32 dots.
	Height	This option can set the height of pop-up screen. The unit is dot. The minimum value is 32 dots.
	Pop-up screen Position	<p>This option can show the pop-up screen on the center of the PT screen or on a position you specify.</p> <p>To specify the position,</p> <ul style="list-style-type: none"> • input the coordinate value directly (X and Y axis) or • press the mouse button  to drag the pop-up screen. 
	Use Title Bar	You can select this option to show the title bar on the pop-up screen.
	Screen Periodic Macro Delay	This option can set the time interval to execute the Screen Periodic Macro. The range can be between 100ms and 5s.
	Fast Refresh Rate	<p>There are three levels, high, medium and low. This function shows four objects immediately after PT switches screens.</p> <p>Note Each screen renews only four objects immediately. To set which objects to be renewed, select Yes in Fast Refresh Field of the property of each object.</p>
Sheet	Applied a Sheet	You can select this option to use other screen as a sheet. The sheet will be background sheet behind all objects.

6-2-7 Tools Menu

	Validation	Ctrl+E
	Test	Ctrl+T
	Option	

Validation

This command validates a project file.

If the project is a new project, you will see the **Save As** Dialog Box before validation. If the project is not a new project, this command does a validation immediately.

The Output Window shows the validation results. If there is no error, this command creates a file.

To do the validation,

- select the **Tools** Menu – **Validation**,
- click the  icon in the toolbar or
- use the keyboard shortcut **Ctrl + E**.

Example: Debugging Validation Errors During Validation Process

1. Create a new project.
2. Create two editing screens.
3. Create a button object on each screen. Do not change the object default property.

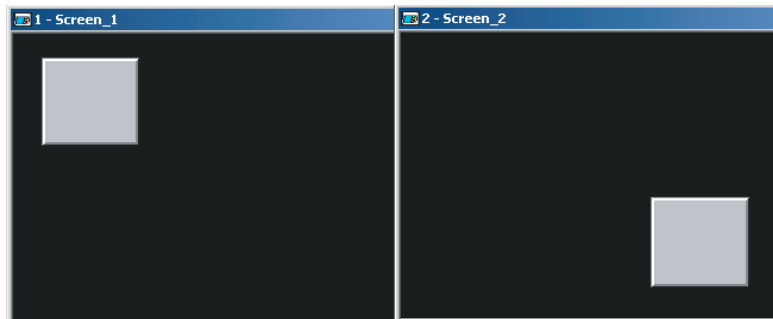

4. Click the  icon to do validation operation. You will see an error message dialog box that shows the number of errors. In the dialog below, there are two errors and the output window shows the errors.

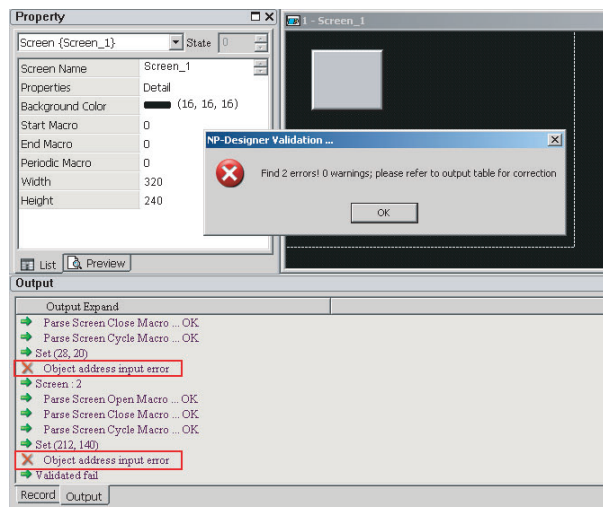

5. Click the error message to switch to the error screen automatically.

■ **Test**

This function tests if the read/write addresses and macro of editing screen are correct or not on a created program. It is not necessary to connect the PLC.

To do the test,

- click the **Tools – Test**
- click the  icon in the toolbar or
- use the keyboard shortcut **Ctrl + T**.

Reference With the Test function, it is not possible to save the date and time settings.

■ **Option**

This function sets the environment settings of NP-Designer.

To show the **Option** Dialog Box, select the **Tools** Menu – **Option**.

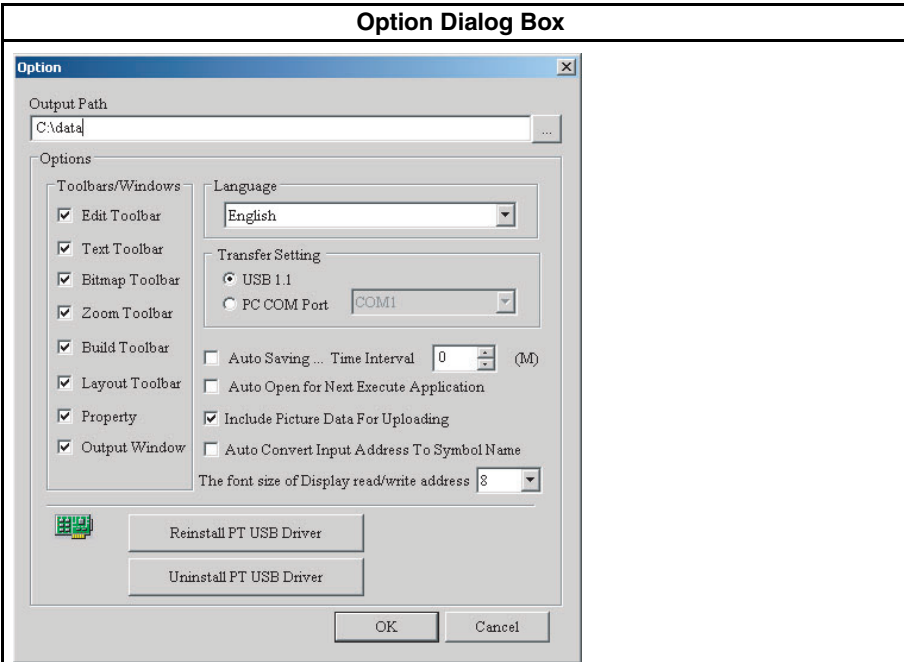
 <p>The screenshot shows the 'Option Dialog Box' with the following settings: Output Path: C:\data; Toolbars/Windows: Edit, Text, Bitmap, Zoom, Build, Layout, Property, Output Window (all checked); Language: English; Transfer Setting: USB 1.1; Auto Saving: 0 (M); Auto Open for Next Execute Application: unchecked; Include Picture Data For Uploading: checked; Auto Convert Input Address To Symbol Name: unchecked; Font size: 8.</p>	
<p>Output Path</p>	<p>This option can set the location where NP-Designer saves the output file after validation. Some functions (Test and file transfer) refer to the files in this location.</p>

Option Dialog Box		
Options	Toolbars/Windows	This option can show or hide the toolbars or windows.
	Language	You can select English, Traditional Chinese, Simplified Chinese, or Japanese.
	Transfer Setting	This option can set the communication interface (USB 1.1 or PC COM Port) for transfer.
	Auto Saving... Time Interval	This option can save the file at the specified time interval. The setting range is between 0 and 120 minutes.
	Auto Open for Next Execute Application	This option can automatically open the file that you last used when the NP-Designer starts.
	Include Picture Data For Uploading	This option can transfer all pictures from the PT to the computer when you upload screen data.
	Auto Convert Input Address To Symbol Name	For example, to replace address "SERIALA:DM00100" with the word "Symbol_A", you must first make this setting in Symbol Table . When this option is selected, the NP-Designer automatically changes the input address "SERIALA:DM00100" to the word "Symbol_A".
	The font size of Display read/write	This option can set the font size of display read and write addresses.
Reinstall PT USB Drive	You can reinstall the PT USB driver.	
Uninstall PT USB Drive	You can uninstall the PT USB driver.	
OK	You can save the changes and exit the Option Dialog Box.	
Cancel	You can discard the changes and exit the Option Dialog Box.	

6-2-8 Window Menu

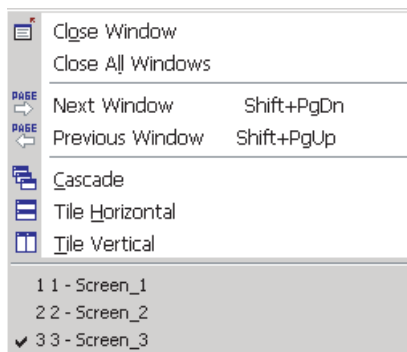

This table tells you about the commands in the Window Menu and their functions.

Menu	Function	Shortcut keys
Close Window	This function hides the current window.	
Close All Windows	This function hides all windows.	
Next Window	Moves the focus from the current window to the next window.	Shift+PgDn
Previous Window	Moves the focus from the current window to the previous window.	Shift+PgUp
Cascade	This function cascades the screen windows.	
Tile Horizontal	This function tiles the screen windows horizontally.	

Menu	Function	Shortcut keys
Tile Vertical	This function tiles the screen windows vertically.	
Window List	This function shows a list of all open screens. The front screen has a check mark.	

6-2-9 Help Menu



■ About NP-Designer

This command shows the version information of the NP-Designer. To show the information,

- select the Help Menu – About NP-Designer or
- click the  icon in the toolbar.



6-3 Toolbars

This section tells you about toolbars. For details on each function, refer to *6-2 Menus*.

■ File Toolbar



Icon	Function
	New
	Open
	Save
	Export
	New Screen
	Open Screen
	Find Content
	Print
	About

■ Edit Toolbar



Icon	Function
	Undo
	Redo
	Cut
	Copy
	Paste
	Delete

■ Text Toolbar







Icon	Function
	Font size
	Font
	Aligns left
	Center
	Aligns right
	Aligns text top
	Center Vertical
	Aligns Bottom
	Font Color
	Bold
	Italic
	Underline

■ Bitmap Toolbar















Icon	Function	Description
	Select Transparent Color	The sucker tool removes the color of the selected picture to specify the transparent color of the picture.
	Change Mode for Process All State Picture	This icon stretches, resizes or aligns not only the current picture with current state but also all pictures with all states.
	Picture Stretch All	This icon resizes the selected picture to fit it to the size of the object.
	Picture Stretch Ration 1: 1	This icon resizes the selected picture to fit it to the size of the object in proportion to the initial picture size.
	Picture Actual	This icon resizes the selected picture to the initial picture size.
	Picture Align Left	This icon aligns the selected picture to the left side of the object.

Icon	Function	Description
	Picture Align Horizontal Center	This icon horizontally aligns the picture to the center of the object.
	Picture Align Right	This icon aligns the selected object to the right side of the object.
	Picture Align Top	This icon aligns the selected object to the top of the object.
	Picture Align Vertical Center	This icon vertically aligns the picture to the center of the object.
	Picture Align Bottom	This icon aligns the selected object to the bottom of the object.

■ Object Toolbar



Icon	Function
	Button
	Analog Meter
	Level Meter
	Pipe
	Lamp
	Data Display
	Graph Display
	Input
	Curve
	Data Log
	Alarm
	Fixed Objects

■ Build Toolbar











Icon	Function
	Current Object State
	View State OFF/0
	View State ON/1
	Display All Read/Write Address
	Previous windows
	Next windows
	Validation
	Transfer [To PT]
	Transfer Screen [To PT]
	Test

■ Layout Toolbar





Icon	Function
	Group
	Ungroup
	To Front
	To Bottom
	Forward one
	Backward one
	Align Left
	Align Right
	Align Top

Icon	Function
	Align Bottom
	Center Vertically
	Center Horizontally
	Make same space horizontally
	Make same space vertically
	Make same width
	Make same height
	Make same size

For details, refer to 6-2-2 Edit Menu.

■ Zoom Toolbar

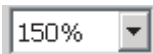

Icon	Function
	Zoom level
	Zoom in
	Zoom out

6-4 Object Functions

The NP-Designer has many objects. You can use these objects to create screens.

This section tells you how to select an object and the function of each object.

6-4-1 Selecting Object

There are three methods to select objects when you edit the screen. To edit the screen, do one of these:

- Right-click the mouse in the workspace. You will see a shortcut menu. Use the mouse to select an object.

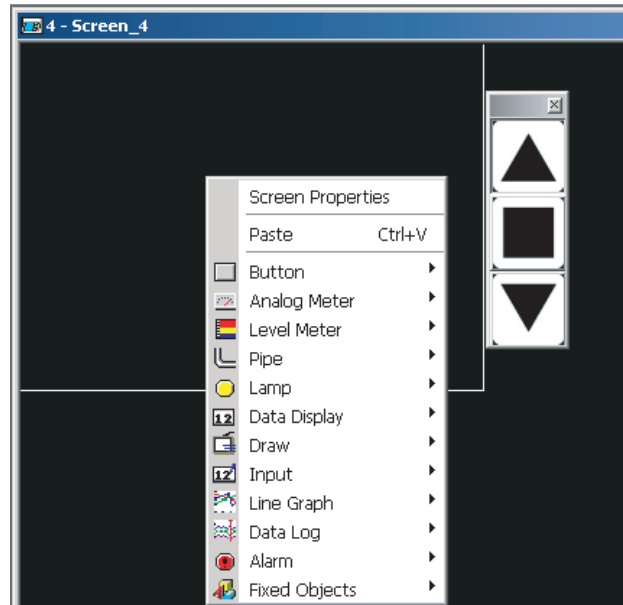

- Select one of the commands from the **Objects** Menu.
- Select one of the objects from the **Objects** Toolbar.



After you select an object, left-click and drag the mouse cursor on the workspace to create an object. See the illustration. Up to 1,024 objects can be created on one screen.

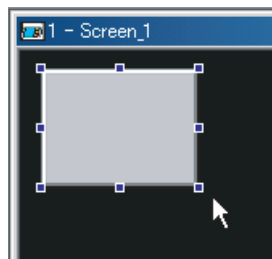









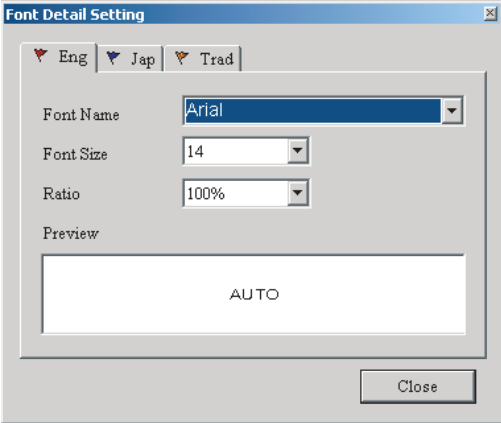

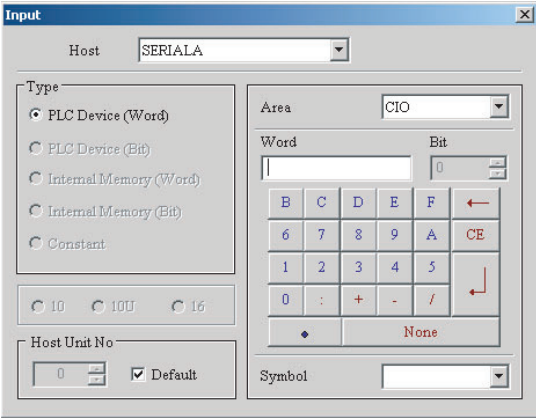
Note When inputting using overlapped objects, an input will be accepted only by the top object. Inputs will not be accepted by objects in the back.

6-4-2 Common Settings

The settings common to all objects show below.

Note Some objects do not have these functions.

Common Settings	Details
<p>Label Label Size Font Label Color</p>	<p>You can set label, label size, font and label color on the object. Click the  button for Font. The Font Detail Setting Dialog Box will show as below.</p>  <p>The font option can set the font name, font size and ratio. This can also show the text format in the Preview window. If you use multi-language function, the Font Detail Setting Dialog Box shows different language tabs. Do the font setting in each language.</p>
<p>Write Address Read Address</p>	<p>Click the  button for Write Address or Read Address in the Property. The Input Dialog Box is shown. Set the write address or read address.</p> <p>When the Read Address is set to None, the Read Address accesses to the same address as the Write Address.</p>  <p>The Host can be Internal Memory or SERIALA. If the PT connects to different connections, the available host names will show in the Host drop-down list. After you select the Host and Type and input the address number, click Enter key. The object will record the input value.</p> <p>When you use Internal Memory as host, select the memory area from the Area Field:</p> <ul style="list-style-type: none"> \$ – Internal Address \$M – Non-volatile Internal Address *\$ – Indirect Address RCPNO – Data Block Number Address RCP – Data Block Address <p>When the NULL is set in Comm. Tab of PT Setting Dialog box under PT Menu, only Internal Memory can be set as the host.</p>
<p>Flicker</p>	<p>When Yes is selected from Flicker Field, the object will flicker (blink).</p>

Common Settings	Details					
<p>Picture Library Name Picture Name</p>	<p>1. Select a picture of the object from the Picture Library Name Field.</p> <p>2. Click  button for Picture Name to show the Select Picture Dialog Box below.</p> <div data-bbox="427 293 1173 995" style="border: 1px solid gray; padding: 5px;"> </div> <p>3. Double-click an image that you use.</p> <p>To import more than one picture into one object at the same time, press the Shift key and click the left mouse button at the same time. The selected pictures will be in each state of the object in sequence. If the number of the selected pictures is more than that of the object states, the system will import only the pictures of the same number of the states. The remaining pictures will not be imported.</p> <p>Note that NP-Designer does not save the Picture Library Name and Picture Name that you specified. When the project file is open again, the Picture Library Name will be “_LocalTempxx” and the Picture Name will be “HMIxx”.</p>					
<p>Transparency Effect Transparency Color</p>	<p>Use the sucker tool  to suck the transparent color of the picture. See the illustrations below for the transparent effect on the object.</p> <table border="1" data-bbox="392 1336 1439 1481"> <thead> <tr> <th data-bbox="392 1336 916 1374">Before the transparent effect</th> <th data-bbox="924 1336 1439 1374">After the transparent effect</th> </tr> </thead> <tbody> <tr> <td data-bbox="392 1378 916 1481">  </td> <td data-bbox="924 1378 1439 1481">  </td> </tr> </tbody> </table>		Before the transparent effect	After the transparent effect		
Before the transparent effect	After the transparent effect					
						
<p>Push Time (s)</p>	<p>You can set the active time of the button between 0 and 10 seconds. When this option is enabled, the button will be active after you press the button longer than the setting time. This option can prevent operation errors.</p>					
<p>User Security Level</p>	<p>You can set the user security level between 0 and 7. (0 is default. 7 is the highest security Level.) When this option is enabled, the user can use only the objects whose security level is equal to or lower than the user's level.</p>					
<p>Set Low Security</p>	<p>When this option is enabled, the security level will be the lowest after the button is pressed. This option can prevent operation errors.</p>					
<p>InterLock Address InterLock Level</p>	<p>InterLock Address: An interlock can be set for accepting inputs for the object based on the status of the communications address.</p> <p>InterLock Level:</p> <ul style="list-style-type: none"> • When Set to ON: Inputting is disabled when the <i>InterLock Address</i> is ON and enabled when it is OFF. • When Set to OFF: Inputting is disabled when the <i>InterLock Address</i> is OFF and enabled when it is ON. 					

Common Settings	Details
ON Macro	Refer to <i>6-5 Macro Function</i> .
OFF Macro	Refer to <i>6-5 Macro Function</i> .
Touch ON Macro	Refer to <i>6-5 Macro Function</i> .
Touch OFF Macro	Refer to <i>6-5 Macro Function</i> .
Trigger Trigger Mode	This function can turn the target PLC address to ON before or after the setting value is written. If it is necessary to turn to ON again, the user must set the address to be OFF manually.
Border Color	You can set the border color of the object.
Background Color	You can set the background color of the object.
Foreground Color	You can set the foreground color of the object.
Fast Refresh	Refer to <i>Properties in 6-2-6 Screen Menu</i> .

6-4-3 Button Objects

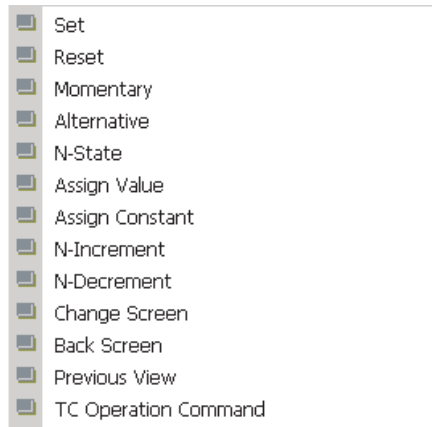





Button	Macro	Read	Write	Function
Set	Touch ON/ Touch OFF	Yes	Yes	This button can turn the setting address (Bit) to ON. The address will be always ON, if you release or press the button again. If there is an Touch ON Macro, the PT will execute it at the same time.
Reset	Touch ON/ Touch OFF	Yes	Yes	This button can turn the setting address (Bit) to OFF. The address will be always OFF, if you release or press the button again. If there is an Touch OFF Macro, the PT will execute it at the same time.
Momentary	Touch ON Touch OFF	Yes	Yes	This button can turn the setting address (Bit) to ON while the button is pressed. When you press the button, the bit is turned ON and the Touch ON Macro is executed. When you release the button, the bit is turned OFF and the Touch OFF macro is executed.
Alternative	Touch ON Touch OFF	Yes	Yes	When you press the button, Touch ON Macro is executed if the bit is turned from OFF to ON or Touch OFF Macro is executed if the bit is turned from ON to OFF.
N-State	ON/ OFF	Yes	Yes	There are 1 to 256 user-defined multi-states. This button can change its state by the read address.
Assign Value	ON/ OFF	No	Yes	When you press this button, the Numeric keypad Dialog Box will show on the screen. You can input the setting value directly. After you press ENTER key, the PT will transmit the input value to the setting address.
Assign Constant	ON/ OFF	No	Yes	This button will write the specified value into the setting address.

Button	Macro	Read	Write	Function
N-Increment	ON/OFF	Yes	Yes	This button will add the setting address value to the setting constant value and write the result to the setting address.
N-Decrement	ON/OFF	Yes	Yes	This button will subtract the setting constant value from the setting address value and write the result to the setting address.
Change Screen	ON/OFF	No	No	This button can show the screen you specified.
Back Screen	ON/OFF	No	No	This button can show the previous screen.
Previous View	ON/OFF	No	No	This button can show the previous screen in an order that the change screen button shows.
TC Operation Command	No	No	Yes	This button can send commands to temperature controllers.

■ General Buttons

There are four types of general buttons: set button, reset button, momentary button and alternative button. When you press these buttons, the PT will transmit ON/OFF signal to the PLC.

For details on functions common to all objects, refer to *6-4-2 Common Settings*.

Property of General Buttons				
Style	Standard	Raised	Round	Invisible
				
	You can set the button style.			
Function	You can change the function of the general buttons. You do not have to create a new object.			

■ N-State Button

For details on functions common to all objects, refer to *6-4-2 Common Settings*.

Property of N-State Button	
The N-State button is a button that has more than one state.	
Data Length	The data length can be bit, word or LSB.
Read Format	The read format can be BCD, signed decimal, unsigned decimal or hexadecimal. This option is available only when the data length is word.
Add/Remove State	You can set the number of states of the object. The setting range will change by the data length. Word: 256 states LSB: 16 states Bit: 2 states
Sequence	You can set the sequence of the N-state object (previous state/next state).

Example of N-State button:

When the data length is LSB (from D100.0-D100.1 to D100.3-D100.4), N-State button will change as below.



S0=D100.0 ON S1=D100.1 ON S2=D100.2 ON S3=D100.3 ON S4=D100.4 ON

■ Assign Value Button

For details on functions common to all objects, refer to 6-4-2 Common Settings.

Property of Assign Value Button		
When you press this button on the screen, the numeric keypad (TEN-KEY) will show. Input the setting value and press ENTER key. The PT will send the value to the specified address.		
Detail Range Setup		
	Data Length	The data length can be word (16bits) or double word (32bits).
	Data Format	You can select the data format from below: Word: BCD, signed decimal, unsigned decimal or hexadecimal, binary. Double Word: BCD, signed decimal, unsigned decimal, hexadecimal, binary or float.
	Minimum	You can set the minimum and maximum value of the input setting range.
	Maximum	
	Integer Digits	You can set the integer or fraction digits. The digit number will be an actual digit number only when the data format is selected as float.
	Fraction Digits	

Example of Assign Value Button:

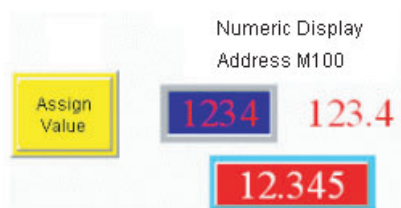

Numeric keypad (TEN-KEY) dialog box:

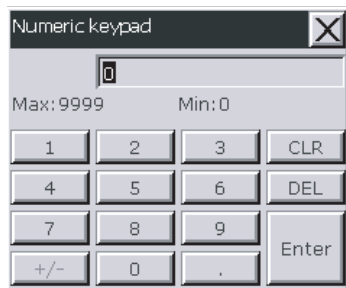

■ Assign Constant Button

For details on functions common to all objects, refer to 6-4-2 Common Settings.

Property of Assign Constant Button	
When you press this button on the screen, the PT will send the value to the PLC address. This button has the same function as the assign value button has.	
Detail Range Setup	
Data Length	The data length can be word (16 bits) or double word (32 bits).
Data Format	The read format can be BCD, signed decimal, unsigned decimal or hexadecimal.
Detail	You can enter the constant value to write in the address.

■ N-Increment / N-Decrement Buttons

For details on functions common to all objects, refer to 6-4-2 Common Settings.

Property of N-Increment / N-Decrement Buttons	
When you press these buttons on the screen, the PT will read the value from the PLC address. The read value adds to or subtracts from the set constant value, and the PT will write the result into the address. When the user press the button, the PT will write the limit value (minimum or maximum) to the address, if the result is out of the limit.	
Function	You can change the function of the N-Increment buttons and N-Decrement buttons. You do not have to create a new object.

Property of N-Increment / N-Decrement Buttons									
Detail Range Setup									
	<table border="1"> <tr> <td>Data Length</td> <td>The data length can be word (16 bits) or double word (32 bits).</td> </tr> <tr> <td>Data Format</td> <td>The read format can be BCD, signed decimal, unsigned decimal or hexadecimal.</td> </tr> <tr> <td>Jog Step</td> <td>You can set the increment or decrement value. This will be the number to add or subtract when you press the buttons each time.</td> </tr> <tr> <td>Limit</td> <td>You can set the maximum or minimum number of the increment or decrement value.</td> </tr> </table>	Data Length	The data length can be word (16 bits) or double word (32 bits).	Data Format	The read format can be BCD, signed decimal, unsigned decimal or hexadecimal.	Jog Step	You can set the increment or decrement value. This will be the number to add or subtract when you press the buttons each time.	Limit	You can set the maximum or minimum number of the increment or decrement value.
	Data Length	The data length can be word (16 bits) or double word (32 bits).							
	Data Format	The read format can be BCD, signed decimal, unsigned decimal or hexadecimal.							
	Jog Step	You can set the increment or decrement value. This will be the number to add or subtract when you press the buttons each time.							
Limit	You can set the maximum or minimum number of the increment or decrement value.								
Data Length	The data length can be word (16 bits) or double word (32 bits).								
Data Format	The read format can be BCD, signed decimal, unsigned decimal or hexadecimal.								
Jog Step	You can set the increment or decrement value. This will be the number to add or subtract when you press the buttons each time.								
Limit	You can set the maximum or minimum number of the increment or decrement value.								

Example of N-Increment / N-Decrement buttons:

To adjust D1000 value, press +/- Buttons.

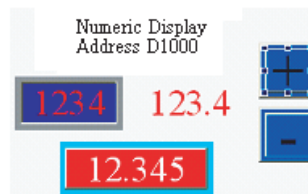

■ Change Screen / Back Screen / Previous View Buttons

For details on functions common to all objects, refer to 6-4-2 Common Settings.

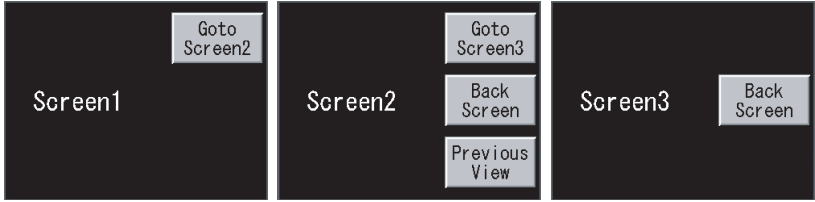
Property of Change Screen / Back Screen / Previous View Buttons	
<p>These three buttons can change screens.</p> <ul style="list-style-type: none"> • Change Screen: When you press this button on the screen, the PT will change the screen to the target screen. • Back Screen: When you press this button on the screen, the PT will change the screen to the previous screen. • Previous View: When you press this button on the screen, the PT will change to the previous view. 	
	
<p>These are the examples of screen changes.</p> <p>Change Screen Button: On Screen1, if you press the “Goto Screen2” button, Screen1 will change to Screen2. If you press the “Goto Screen3” button on Screen2, it will change to Screen3. Back Screen Button: If you press the “Back Screen” button on Screen3, the screen will change to Screen2 shown one screen before the active one. If you press the “Back Screen” button on Screen2, it will change to Screen3.</p> <p>Previous View Button: If you press the “Previous View” button on Screen2, it will change to Screen1.</p>	
Function	You can change the function of the change screen, back screen, and previous view buttons. You do not have to create a new object.

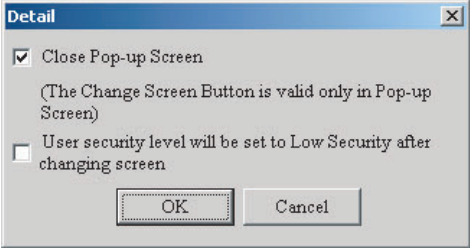
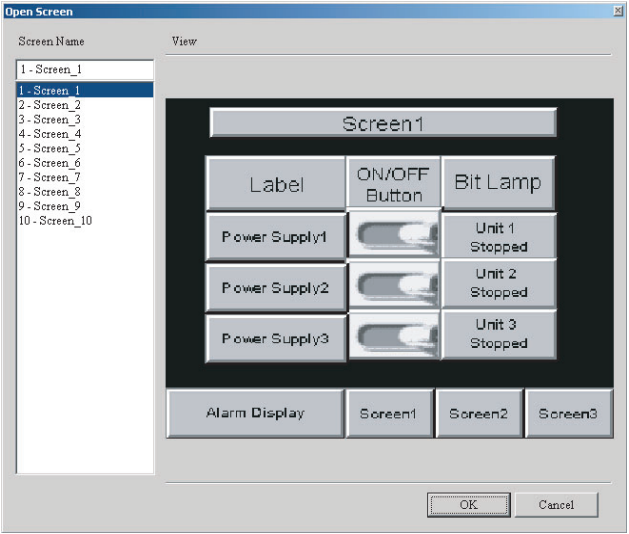
Property of Change Screen / Back Screen / Previous View Buttons					
Input Value	 <p>Note This option is for the change screen button only.</p> <table border="1"> <tr> <td style="vertical-align: top;">Close Pup-up Screen</td> <td>You can select this check box only when the button is placed on a pop-up screen. When you press this button on the pop-up screen, the PT will close that pop-up screen.</td> </tr> <tr> <td style="vertical-align: top;">User security level will be set to Low Security after changing the screen</td> <td>When this option is enabled, the security level will be the lowest after the button is pressed. This option can prevent operation errors.</td> </tr> </table>	Close Pup-up Screen	You can select this check box only when the button is placed on a pop-up screen. When you press this button on the pop-up screen, the PT will close that pop-up screen.	User security level will be set to Low Security after changing the screen	When this option is enabled, the security level will be the lowest after the button is pressed. This option can prevent operation errors.
Close Pup-up Screen	You can select this check box only when the button is placed on a pop-up screen. When you press this button on the pop-up screen, the PT will close that pop-up screen.				
User security level will be set to Low Security after changing the screen	When this option is enabled, the security level will be the lowest after the button is pressed. This option can prevent operation errors.				
Goto Screen	<p>You can set a destination screen. Click this option to show the dialog box as below.</p>  <p>When you select one of the screens from the left pane of the Dialog Box, the preview screen will show on the right pane.</p> <p>Note This option is for the change screen button only.</p>				

■ TC Operation Command

For details on functions common to all objects, refer to *6-4-2 Common Settings*.

When EJ1 is specified as a protocol, the TC Operation Command button is available.

For how to set the protocol, refer to *Communication Tab in PT Setting Dialog Box of 6-2-4 PT Menu*.



The TC Operation Command buttons can send commands to temperature controllers.

To specify the commands, use the *Input* Dialog Box of **Write Address** option. For details on each command, refer to the manual for temperature controller.

■ System Function Button

-  System Date & Time
-  Password Table Setup
-  Enter Password
-  Contrast & Brightness
-  Low Security
-  System Menu

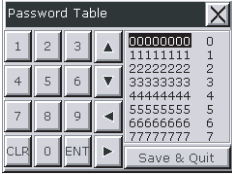
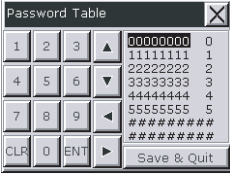
For details on functions common to all objects, refer to 6-4-2 *Common Settings*.

Property of System Function Button	
Function	<p>You can change the function of the system function buttons. You do not have to create a new object.</p>
System Date & Time	<p>When you press this button on the screen, the PT will show the Date/Time Dialog Box. You can set year, month and date, hour, minute and second, and save them in the PT system.</p> 
Password Table Setup	<p>When you press this button on the screen, PT will show the Password Table Dialog Box. You can only change and see the passwords that are the same or lower than your security level.</p> <p>If the setting level is higher than your security level, you cannot change and see the passwords.</p> <div style="display: flex; justify-content: space-around;"> <div style="text-align: center;">  <p>User security level 7</p> </div> <div style="text-align: center;">  <p>User security level 5</p> </div> </div> <p>Even if you replace the screen data, the passwords in the Password Table will be the same.</p>
Enter Password	<p>When you press this button on the screen, PT will show the Password Keypad Dialog Box. You can input a password to change your security level of PT. When you input a higher level password, you can access the higher level objects.</p> 

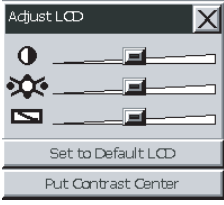
Property of System Function Button		
Function	Contrast & Brightness	<p>When you press this button on the screen, the PT will show the Adjust LCD Dialog Box. You can adjust LCD contrast and brightness settings of the PT.</p> <p>If you press the Set to Default LCD Button, the LCD settings will be default. If you press Put Contrast Center Button, the contrast adjustment bar will move to the middle.</p> 
	Low Security	The user security level will become the lowest level (Level 0).
	System Menu	When you press this button on the screen, the PT will show the system menu. To return to the user screen, press the Exit Button on the system menu.

6-4-4 Meter (1 to 3)



For details on functions common to all objects, refer to 6-4-2 *Common Settings*.

■ Meter (1 to 3)

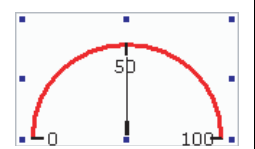
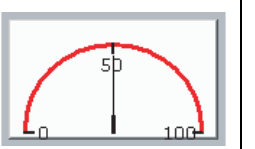
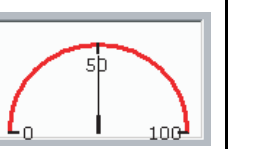
Property of Meter (1 to 3)			
You can use the meter (1 to 3) to monitor whether the value of the address is more than the limit or not.			
Style	Standard	Raised	Sunken
			

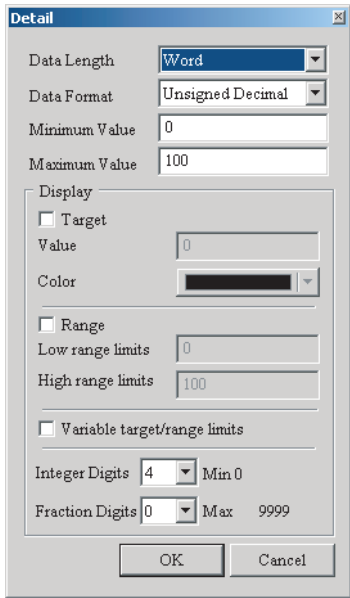
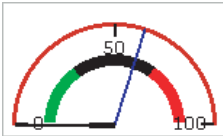
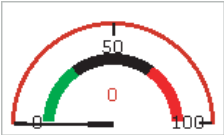
Property of Meter (1 to 3)	
Detail	
Data Length	The data length can be word (16bits) or double word (32bits).
Data Format	The data format can be BCD, signed decimal or unsigned decimal.
Minimum Value	You can set the minimum and maximum value of the display.
Maximum Value	
Target Value Color	<p>You can select the Target option to specify the target value and color. Thus the object will show the target value and the color that you set.</p> <p>See the illustration below.</p> <p>The target value is 60 and the color is blue.</p> 
Range	Refer to the <i>Low Region Color</i> and <i>High Region Color</i> of this property.
Variable target/range limits	If you select this option, Read Address+1 is the low limit, Read Address+2 is the high limit and Read Address+3 is the target value.
Integer Digits	You can set the integer and fraction digits for display.
Fraction Digits	
Low Region Color High Region Color	<p>You can set the low and high region color. These options are available only when you select the Ranges option in the Detail Dialog Box.</p> <p>See the illustration below.</p> <p>The low limit value is 30, the color of low region is green, the high limit value is 70, and the color of high region is red.</p> 
Stitch Color	You can set the stitch color.

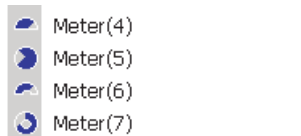

Property of Meter (1 to 3)	
Scale Color	You can set the scale color.
Scale Region Number	You can set the scale region number. The setting range is between 1 and 10.

6-4-5 Meter (4 to 7)



For details on functions common to all objects, refer to 6-4-2 *Common Settings*.

Property of Meter (4 to 7)				
The meter (4 to 7) show the continuous changes of the specified address.				
Border Color	You can set the border color, foreground and background color.			
Foreground Color	See the illustration below.			
Background Color	The border color is blue, the foreground color is green and the background color is yellow.			
Style	Standard	Raised	Sunken	Transparency
Detail				
	Data Length	The data length can be word (16bits) or double word (32bits).		
	Data Format	The data format can be BCD, signed decimal, unsigned decimal or hexadecimal.		
	Minimum Value	You can set the minimum and maximum value of the display.		
Maximum Value				





Property of Meter (4 to 7)		
Detail	Target Value Color	<p>You can select the Target option to specify the target value and color. Thus the object shows the target value and the color that you set.</p> <p>See the illustration below.</p> <p>The target value is 80 and the color is yellow.</p> 
	Range	Refer to the <i>Low Region Color</i> and <i>High Region Color</i> of this property.
	Variable target/ range limits	If you select this option, Read Address+1 is the low limit, Read Address+2 is the high limit, and Read Address+3 is the target value.
Low Region Color High Region Color	<p>You can set the low and high region color. These options are available only when you select the Range option in the Detail Dialog Box.</p> <p>See the illustration below.</p> <p>The low range limit value is 30, the color of low region is green, the high range limit value is 70 and the color of high region is red. The minimum and maximum input value is 0 and 100 respectively.</p>  <p>When the value is 20 When the value is 50 When the value is 80</p>	











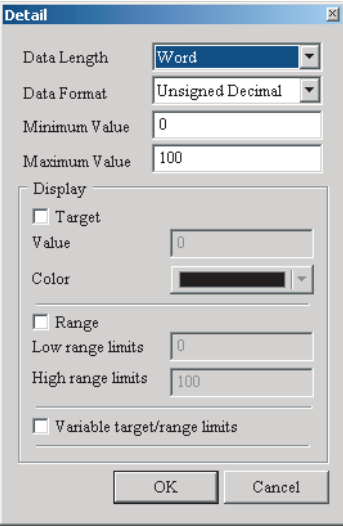

6-4-6 Level Meter













For details on functions common to all objects, refer to 6-4-2 *Common Settings*.





■ Level Meter

Property of Level Meter			
The PT reads the value of the specified host address, and shows the value on the level meter.			
Foreground Color Background Color	<p>You can set the foreground and background color.</p> <p>See the illustration below.</p> <p>The foreground color is green and the background color is light yellow.</p> 		
Style	Standard	Raised	Sunken
			
Display Format	Left	The display progressing direction is from right to left.	
	Right	The display progressing direction is from left to right.	
	Top	The display progressing direction is from bottom to top.	
	Bottom	The display progressing direction is from top to bottom.	

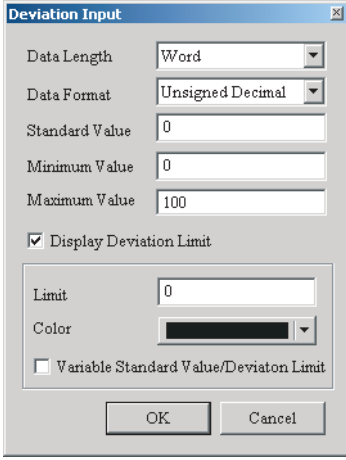
Property of Level Meter								
Value								
	<table border="1"> <tr> <td>Data Length</td> <td>The data length can be word (16bits) or double word (32bits).</td> </tr> <tr> <td>Data Format</td> <td>The data format can be BCD, signed decimal, unsigned decimal or hexadecimal.</td> </tr> <tr> <td>Minimum Value</td> <td rowspan="2">You can set the minimum and maximum value of the display.</td> </tr> <tr> <td>Maximum Value</td> </tr> </table>	Data Length	The data length can be word (16bits) or double word (32bits).	Data Format	The data format can be BCD, signed decimal, unsigned decimal or hexadecimal.	Minimum Value	You can set the minimum and maximum value of the display.	Maximum Value
	Data Length	The data length can be word (16bits) or double word (32bits).						
	Data Format	The data format can be BCD, signed decimal, unsigned decimal or hexadecimal.						
Minimum Value	You can set the minimum and maximum value of the display.							
Maximum Value								
<table border="1"> <tr> <td>Target Value Color</td> <td> <p>You can select the Target option to specify the target value and color. Thus the object will show the target value and the color that you set.</p> <p>See the illustration below.</p> <p>The target value is 50 and the color is red. The maximum and minimum value is 100 and 0 respectively.</p>  </td> </tr> <tr> <td>Range</td> <td>Refer to the <i>Low Region Color</i> and <i>High Region Color</i> of this property.</td> </tr> <tr> <td>Variable target/range limits</td> <td>If you select this option, Read Address+1 is the low limit value, Read Address+2 is the high limit value and Read Address+3 is the target value.</td> </tr> </table>	Target Value Color	<p>You can select the Target option to specify the target value and color. Thus the object will show the target value and the color that you set.</p> <p>See the illustration below.</p> <p>The target value is 50 and the color is red. The maximum and minimum value is 100 and 0 respectively.</p> 	Range	Refer to the <i>Low Region Color</i> and <i>High Region Color</i> of this property.	Variable target/range limits	If you select this option, Read Address+1 is the low limit value, Read Address+2 is the high limit value and Read Address+3 is the target value.		
Target Value Color	<p>You can select the Target option to specify the target value and color. Thus the object will show the target value and the color that you set.</p> <p>See the illustration below.</p> <p>The target value is 50 and the color is red. The maximum and minimum value is 100 and 0 respectively.</p> 							
Range	Refer to the <i>Low Region Color</i> and <i>High Region Color</i> of this property.							
Variable target/range limits	If you select this option, Read Address+1 is the low limit value, Read Address+2 is the high limit value and Read Address+3 is the target value.							
<table border="1"> <tr> <td>Low Region Color</td> <td rowspan="3"> <p>You can set the low and high region color. These options are available only when you select the Range option in the Detail Dialog Box.</p> <p>See the illustration below.</p> <p>The low limit value is 30, the color of low region is green, the high limit value is 70, and the color of high region is red. The minimum and maximum input values are 0 and 100 respectively.</p> </td> </tr> <tr> <td>High Region Color</td> </tr> <tr> <td>Color</td> </tr> </table>	Low Region Color	<p>You can set the low and high region color. These options are available only when you select the Range option in the Detail Dialog Box.</p> <p>See the illustration below.</p> <p>The low limit value is 30, the color of low region is green, the high limit value is 70, and the color of high region is red. The minimum and maximum input values are 0 and 100 respectively.</p>	High Region Color	Color				
Low Region Color	<p>You can set the low and high region color. These options are available only when you select the Range option in the Detail Dialog Box.</p> <p>See the illustration below.</p> <p>The low limit value is 30, the color of low region is green, the high limit value is 70, and the color of high region is red. The minimum and maximum input values are 0 and 100 respectively.</p>							
High Region Color								
Color								
<table border="1"> <tr> <td>  </td> <td>  </td> <td>  </td> </tr> <tr> <td>When the value is 20</td> <td>When the value is 50</td> <td>When the value is 80</td> </tr> </table>				When the value is 20	When the value is 50	When the value is 80		
								
When the value is 20	When the value is 50	When the value is 80						

■ Deviation Object

Property of Deviation Object							
The PT reads the value of the specified host address and subtracts the setting standard value from this read value to get a deviation value. Then, the PT shows this deviation value on the deviation object.							
Foreground Color Background Color	<p>You can set the foreground and background color. See the illustration below.</p> <p>The foreground color is green and the background color is light yellow.</p> 						
Style	<table border="1"> <thead> <tr> <th>Standard</th> <th>Raised</th> <th>Sunken</th> </tr> </thead> <tbody> <tr> <td></td> <td></td> <td></td> </tr> </tbody> </table>	Standard	Raised	Sunken			
Standard	Raised	Sunken					
							
Display Format	Horizontal The deviation value shows horizontally.						
	Vertical The deviation value shows vertically.						
Value							
	Data Length	The data length can be word (16bits) or double word (32bits).					
	Data Format	The data format can be BCD, signed decimal, unsigned decimal or hexadecimal.					
	Standard Value	You can set the standard value to calculate the deviation value.					
	Minimum Value	You can set the minimum and maximum value of the display.					
	Maximum Value						
	Display Deviation Limit	<p>If you select this option, you can specify the deviation limit and color to show the deviation value in the color you specified.</p> <p>If you deselect this option, the deviation object shows the deviation value in the foreground color.</p>					
	Limit	You can set the limit value.					
	Color	You can set the display color of the limit value.					
	Variable Standard Value/Deviation Limit	If you select this option, Read Address+1 is the standard value and Read Address+2 is the deviation limit value.					





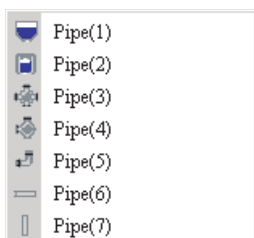



Property of Deviation Object	
Detail	<p>Example:</p> <p>If the data length is word, the data format is unsigned decimal, the standard value is 50, the minimum value is 0, the maximum value is 100 and the deviation limit is 20, the deviation object will show as follows.</p> <div style="display: flex; justify-content: space-around; align-items: flex-start;"> <div style="text-align: center;">  <p>When the value is 10</p> </div> <div style="text-align: center;">  <p>When the value is 20</p> </div> </div> <div style="display: flex; justify-content: space-around; align-items: flex-start; margin-top: 10px;"> <div style="text-align: center;">  <p>When the value is 70</p> </div> <div style="text-align: center;">  <p>When the value is 90</p> </div> </div>





6-4-7 Pipe

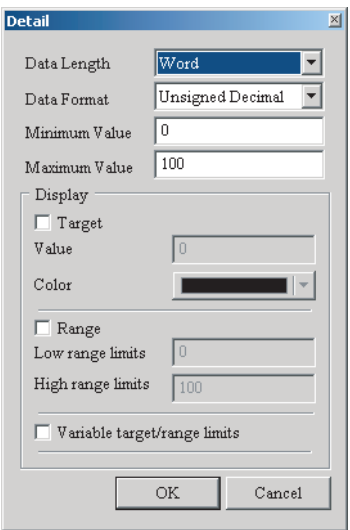

For details on functions common to all objects, refer to 6-4-2 *Common Settings*.

■ Pipe (1) / Pipe (2)

Property of Pipe (1) / Pipe (2)					
The PT reads the value of the specified host address, and shows the value on the pipe (1) / pipe (2).					
Water Mark Color Inside Tube Color	<p>You can set the watermark color and inside tube color. See the illustration below.</p> <div style="display: flex; justify-content: space-around; align-items: center;"> <div style="text-align: center;"> <p>Pipe (1)</p>  <p>The Water Mark Color is blue. The Inside Tube Color is black.</p> </div> <div style="text-align: center;"> <p>Pipe (2)</p>  <p>The Water Mark Color is red. The Inside Tube Color is white.</p> </div> </div>				
Style	<table border="1" style="width: 100%; text-align: center;"> <thead> <tr> <th>Standard</th> <th>Rotation 180</th> </tr> </thead> <tbody> <tr> <td>  </td> <td>  </td> </tr> </tbody> </table>	Standard	Rotation 180		
Standard	Rotation 180				
					

Property of Pipe (1) / Pipe (2)								
Detail								
	<table border="1"> <tr> <td>Data Length</td> <td>The data length can be word (16bits) or double word (32bits).</td> </tr> <tr> <td>Data Format</td> <td>The data format can be BCD, signed decimal, unsigned decimal or hexadecimal.</td> </tr> <tr> <td>Minimum Value</td> <td rowspan="2">You can set the minimum and maximum value of the pipe object.</td> </tr> <tr> <td>Maximum Value</td> </tr> </table>	Data Length	The data length can be word (16bits) or double word (32bits).	Data Format	The data format can be BCD, signed decimal, unsigned decimal or hexadecimal.	Minimum Value	You can set the minimum and maximum value of the pipe object.	Maximum Value
Data Length	The data length can be word (16bits) or double word (32bits).							
Data Format	The data format can be BCD, signed decimal, unsigned decimal or hexadecimal.							
Minimum Value	You can set the minimum and maximum value of the pipe object.							
Maximum Value								
Detail	<table border="1"> <tr> <td>Target Value Color</td> <td>You can select the Target option to specify the target value and color. Thus the object will show the target value and the color that you set.</td> </tr> <tr> <td>Range</td> <td>Refer to the <i>Low Region Color</i> and <i>High Region Color</i> of this property.</td> </tr> <tr> <td>Variable target/range limits</td> <td>This option is available only when you select the Target and Range Options. Read Address+1 is the low limit value, Read Address+2 is the high limit value and Read Address+3 is the target value.</td> </tr> </table>	Target Value Color	You can select the Target option to specify the target value and color. Thus the object will show the target value and the color that you set.	Range	Refer to the <i>Low Region Color</i> and <i>High Region Color</i> of this property.	Variable target/range limits	This option is available only when you select the Target and Range Options. Read Address +1 is the low limit value, Read Address +2 is the high limit value and Read Address +3 is the target value.	
Target Value Color	You can select the Target option to specify the target value and color. Thus the object will show the target value and the color that you set.							
Range	Refer to the <i>Low Region Color</i> and <i>High Region Color</i> of this property.							
Variable target/range limits	This option is available only when you select the Target and Range Options. Read Address +1 is the low limit value, Read Address +2 is the high limit value and Read Address +3 is the target value.							
Low Region Color High Region Color	<p>You can set the low and high region color. These options are available only when the Range option in the Detail Dialog Box is selected. See the illustration below.</p> <p>The low limit value is 30, the color of low region is green, the high limit value is 70 and the color of high region is red. The minimum and maximum input value is 0 and 100 respectively.</p> <div style="display: flex; justify-content: space-around; align-items: center;"> <div style="text-align: center;">  <p>When the value is 20</p> </div> <div style="text-align: center;">  <p>When the value is 50</p> </div> <div style="text-align: center;">  <p>When the value is 80</p> </div> </div>							



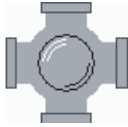

■ Pipe (3)

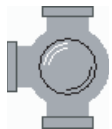
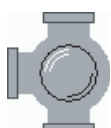
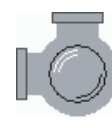
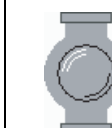
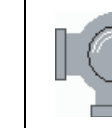
Property of Pipe (3)	
This object connects to several pipes. The pipe (3) shows as follows.	
	
Pipe Gauge	You can set the pipe gauge. The selectable range is between 1 and 5. 1 is 13 dots and 2 is 26 dots. The size for 3 to 5 increases progressively.



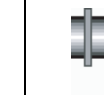

■ Pipe (4)

Property of Pipe (4)				
This object connects to several pipes. The pipe (4) shows as follows.				
				
Style	Standard	Rotation 90	Rotation 180	Rotation 270
				
Pipe Gauge	You can set the pipe gauge. The selectable range is between 1 and 5. 1 is 13 dots and 2 is 26 dots. The size for 3 to 5 increases progressively.			

■ Pipe (5)

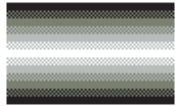
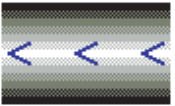
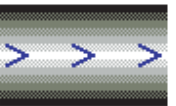
Property of Pipe (5)				
This object connects to several pipes. The pipe (5) shows as follows.				
				
Style	Standard	Rotation 90	Rotation 180	Rotation 270
				
Pipe Gauge	You can set the pipe gauge. The selectable range is between 1 and 5. 1 is 13 dots and 2 is 26 dots. The size for 3 to 5 increases progressively.			

■ Pipe (6) / Pipe (7)





Property of Pipe (6) / Pipe (7)			
The pipe (6) and (7) are horizontal and vertical pipes. The PT shows the direction of water flow by the change of the read address.			
	Value of Read Address = 0	Value of Read Address = 1	Value of Read Address = 2
Pipe 6			
Pipe 7			
Mobile Cursor Color	You can set the mobile cursor color. The mobile cursor will show when there is any data occurred in the read address.		
Pipe Gauge	You can set the pipe gauge. The range is between 1 and 5. 1 is 13 dots and 2 is 26 dots. The size for 3 to 5 increases progressively.		

6-4-8 Lamp



For details on functions common to all objects, refer to 6-4-2 Common Settings.

■ N-State Lamp

Property of N-State Lamp				
The N-state lamp is a lamp that has n states.				
Read Address	Refer to 6-4-2 Common Settings for details on how to set the read address. When you set the read address with the contact of the host, the n-state lamp will change with the state (ON or OFF) of the host contact. For example, you can set the state settings of the n-state lamp to show the text "Start" when the value is 1 and to show the text "Stop" when the value is 0. You can also add a picture to each state to show a different picture for each state.			
Style	Standard	Raised	Round	Invisible
				
Data Length	The data length can be bit, word or LSB.			

Property of N-State Lamp	
Read Format	The read format can be BCD, signed decimal, unsigned decimal or hexadecimal. This option is available only when the data length is word.
Add/Remove State	You can set the number of states of the object. The setting range will change by the data length. Word: 256 states LSB: 16 states Bit: 2 states

Example of n-state lamps:

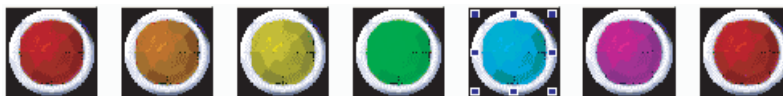

■ Range Lamp

Property of Range Lamp				
The range lamp shows the state of specified address in the data length.				
Style	Standard	Raised	Round	Invisible
Add/Remove State	You can set the number of states of the object. The setting range will change by the data length. Word: 256 states			
Detail				

Property of Range Lamp																								
Detail	Data Length	The data length can be word (16bits) or double word (32bits).																						
	Data Format	The data format can be BCD, signed decimal or unsigned decimal.																						
	Range	Variable Limits	When n is the total number of states, n will also be the total number of ranges. You can use addresses to specify the lower limit of each range. For example, If the read address is \$0, and the total number of states is 5, you can use range 0 to 4. The lower limit value of range 0 is \$1, the lower limit value of range 1 is \$2. For the range 2 and greater the address increases progressively.																					
		Constant Limits	When n is the total number of states, n will also be the total number of ranges. You can specify the limit of each range. For example, when the number of states is 5, the number of ranges will be 5 (0 to 4). You can specify the foreground color of state 0, 1, 2, 3, and 4 as red, green, blue, yellow and purple, respectively.																					
		<table border="1"> <thead> <tr> <th>Range 0</th> <th>Range 1</th> <th>Range 2</th> <th>Range 3</th> <th>Range 4</th> </tr> </thead> <tbody> <tr> <td>100</td> <td>50</td> <td>33</td> <td>1</td> <td>0</td> </tr> </tbody> </table> <p>The below shows the relationships between the value of the read address and the range lamp color.</p> <table border="1"> <thead> <tr> <th>Value of Read Address</th> <th>Range Lamp Color</th> </tr> </thead> <tbody> <tr> <td>100 and more</td> <td>Red</td> </tr> <tr> <td>50 to 99</td> <td>Green</td> </tr> <tr> <td>33 to 49</td> <td>Blue</td> </tr> <tr> <td>1 to 32</td> <td>Yellow</td> </tr> <tr> <td>0 and less</td> <td>Purple</td> </tr> </tbody> </table>	Range 0	Range 1	Range 2	Range 3	Range 4	100	50	33	1	0	Value of Read Address	Range Lamp Color	100 and more	Red	50 to 99	Green	33 to 49	Blue	1 to 32	Yellow	0 and less	Purple
Range 0	Range 1	Range 2	Range 3	Range 4																				
100	50	33	1	0																				
Value of Read Address	Range Lamp Color																							
100 and more	Red																							
50 to 99	Green																							
33 to 49	Blue																							
1 to 32	Yellow																							
0 and less	Purple																							

■ Simple Lamp

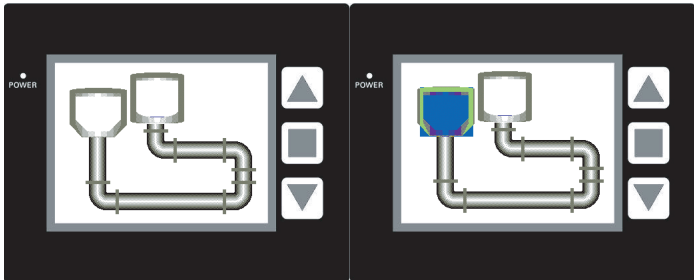
Property of Simple Lamp	
<p>The simple lamp has two states (ON/OFF). Thus, it is possible to emphasize some display parts of the screen. In the example below, there are simple lamps on the pipes. The simple lamps will change as shown on the right figure below.</p>	
	
XOR Color	You can set XOR color of base picture.

Precautions for Correct Use

When an object is positioned in the behind a simple lamp, the object in back will not be refreshed while the simple lamp is illuminated, even if the object display changes.

6-4-9 Data Display Object

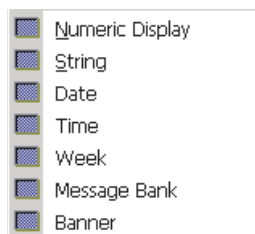



For details on functions common to all objects, refer to 6-4-2 *Common Settings*.

■ Numeric Display Object

Property of Numeric Display Object				
The numeric display object reads the value of the setting address, and shows the read value in the format that you set.				
Label Size Label Color	You can set the label size and label color. The label size can be between 8 and 64.			
Style	Standard	Raised	Sunken	Transparency
Leading Zero	You can add or remove the leading zero to each value. The integral digits are set to 4.			
		When YES is selected		
		When NO is selected		
Detail				
	Data Length	The data length can be word (16bits) or double word (32bits).		
	Data Format	You can set any of the data formats below. Word: BCD, signed decimal, unsigned decimal, hexadecimal or binary. Double Word: BCD, signed decimal, unsigned decimal, hexadecimal, binary or float.		
	Integral Digits	You can set the integral and fraction digits. The digit numbers will be an actual digit number only when the data format is selected as Float .		
	Fraction Digits			

Property of Numeric Display Object		
Detail	Gain (a)	You can gain and offset the display numeric value (y) by the equation $y = (a) \times (\text{read address value}) + (b)$. For example, if Gain value (a) is 2, Offset value (b) is 3 and the read address value is 4, then the display numeric value will be $2 \times 4 + 3 = 11$.
	Offset (b)	
	Round off	If you select this option, the result (y) of the equation above can be rounded off.

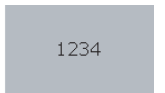
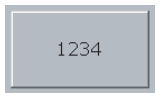
■ String Display Object

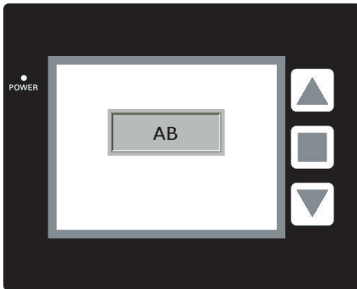
Property of String Display Object				
This string display object reads the value of the specified address, and converts it to text to show it on the screen. The value of read address must be set in ASCII format.				
Read Address	Refer to 6-4-2 Common Settings.			
Label Size Label Color	You can set the label size and label color. The label size can be between 8 and 64.			
Style	Standard	Raised	Sunken	Transparency
				
Characters Length	The characters length can be between 1 and 28 characters.  For example, if the read address is \$0, the characters length is 2 and the value at \$0 is set as follows, the above screen will show. \$0 = 4142H			

■ Date Display Object

Property of Date Display Object	
The date display object shows the PT system date.	
Label Size Label Color	You can set the label size and label color. The label size can be between 8 and 64.
Style	Refer to the <i>Property of Numeric Display Object</i> .
Date Format	MM/DD/YY, DD/MM/YY, DD.MM.YY, YY/MM/DD

■ Time Display Object

Property of Time Display Object	
The time display object shows the PT system time.	
Label Size Label Color	You can set the label size and label color. The label size can be between 8 and 64.
Style	Refer to the <i>Property of Numeric Display Object</i> .
Time Format	HH:MM:SS, HH:MM

■ Week Display Object

Property of Week Display Object	
The week display object shows the day (Sunday to Monday) of the week. The state default setting is 0 (0: SUN to 6: SAT). Each state has its predefined day description, such as SUN, MON ... SAT. You can change it in the property.	
Style	Refer to the <i>Property of Numeric Display Object</i> .

■ Message Bank Object

Property of Message Bank Object	
The message bank object shows the state content of the specified host contact or address.	
Style	Refer to the <i>Property of Numeric Display Object</i> .
Data Type	The data type can be bit, word or LSB.
Read Format	The read format can be BCD, signed decimal, unsigned decimal or hexadecimal. This option is available only when the data length is word.
Add/Remove State	You can set the number of states of the object. The setting range will change by the data length. Bit: 2 states Word: 256 states LSB: 16 states

■ Banner Object

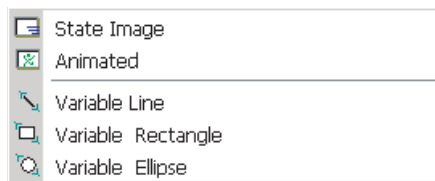

Property of Banner Object		
The banner object moves, lights and shows in the way you set, and shows the state content of specified host contact or address.		
Style	Refer to the <i>Property of Numeric Display Object</i> .	
Data Length	The data length can be bit, word or LSB.	
Read Format	The read format can be BCD, signed decimal, unsigned decimal or hexadecimal. This option is available only when the data length is word.	
Add/Remove State	You can set the number of states of the object. The setting range will change by the data length. Word: 256 states LSB: 16 states Bit: 2 states	
Direction	Left	The display progressing direction is from right to left.
	Right	The display progressing direction is from left to right.
	Top	The display progressing direction is from bottom to top.
	Bottom	The display progressing direction is from top to bottom.
Movement Distance	You can set the movement distance of the message. The range is between 1 and 50 dots.	
Interval (ms)	You can set the time interval between movements. The range is between 50 and 3000 ms.	

6-4-10 Draw Objects



For details on functions common to all objects, refer to 6-4-2 *Common Settings*.

■ **State Image Object**

Property of State Image Object		
You can use this object to show one or more states on the specified position of the PT screen. Each state can show a different picture.		
Data Length	The data length can be bit, word or LSB.	
Read Format	The read format can be BCD, signed decimal, unsigned decimal or hexadecimal. This option is available only when the data length is word.	
Add/Remove State	You can set the number of states of the object. The setting range will change by the data length. Bit: 2 states Word: 256 states LSB: 16 states	
Auto Change	No	The value of read address sets the state number.
	Yes	When the value of read address is 1 or more, the object will change automatically. When the value of read address is 0, the state will not change automatically.
	Variation	Read Address+1 1 or more: The states will change automatically. 0: The states will not change automatically.
Change Rate (ms)	You can set the automatic change interval of the states. The change rate is between 100 and 3000 ms.	
Transparency Effect Transparency Color Foreground Color Transparency	If you select Yes , the transparent color specified in the object will be invisible. This option comes with the Transparency Color setting of the object. See the illustrations: <div style="display: flex; align-items: center; margin-top: 10px;"> <div style="border: 1px dashed gray; padding: 5px; margin-right: 10px;">  </div> <div> <p>Transparency Effect is No. Transparency Color is disabled.</p> </div> </div> <div style="display: flex; align-items: center; margin-top: 10px;"> <div style="border: 1px dashed gray; padding: 5px; margin-right: 10px;">  </div> <div> <p>Foreground color transparency is Yes.</p> </div> </div> <div style="display: flex; align-items: center; margin-top: 10px;"> <div style="border: 1px dashed gray; padding: 5px; margin-right: 10px;">  </div> <div> <p>Transparency Effect and Transparency is Yes. The object becomes transparent.</p> </div> </div>	

Example of state image objects:

The read address = D100.

The relation between the Internal Memory value and each state shows below:



D100=1 D100=2 D100=3 D100=4

■ Animated Object

Property of Animated Object	
You can move and show the animated object on the screen by control of horizontal and vertical axes position. A different picture can show for each state.	
Read Address	Refer to 6-4-2 <i>Common Settings</i> for how to set read address.
	Read Address The value of Read Address is the state of the animated object.
	Read Address+1 The value of Read Address+1 is the horizontal axis position.
	Read Address+2 The value of Read Address+2 is the vertical axis position.
Clear Picture	You can clear the previous animated object when the object moves or the state of the object changes.
Data Length	The data length can be word or LSB.
Read Format	The read format can be BCD, signed decimal, unsigned decimal or hexadecimal. This option is available only when the data length is word.
Add/Remove State	You can set the number of states of the object. The setting range will change by the data length. Word: 256 states LSB: 16 states

■ Variable Line Object

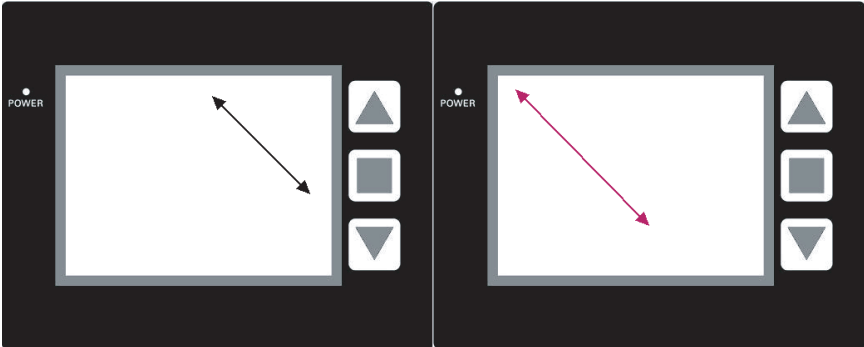
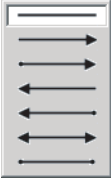
Property of Variable Line Object																						
<p>You can change the color, shape and display position of the variable line object by the value of the read address.</p>																						
																						
Read Address	<p>Refer to 6-4-2 <i>Common Settings</i> for how to set read address.</p> <table border="1" style="width: 100%; border-collapse: collapse; margin-top: 10px;"> <thead> <tr> <th style="width: 30%; padding: 5px;">Variable Position</th> <th style="width: 35%; padding: 5px;">Yes</th> <th style="width: 35%; padding: 5px;">No</th> </tr> </thead> <tbody> <tr> <td style="padding: 5px;">Read Address</td> <td style="padding: 5px;">Horizontal axis position of the start point</td> <td style="padding: 5px;">Color /Flicker (see note)</td> </tr> <tr> <td style="padding: 5px;">Read Address+1</td> <td style="padding: 5px;">Vertical axis position of the start point</td> <td style="padding: 5px;">Flicker (see note)</td> </tr> <tr> <td style="padding: 5px;">Read Address+2</td> <td style="padding: 5px;">Horizontal axis position of the end point</td> <td style="padding: 5px;"></td> </tr> <tr> <td style="padding: 5px;">Read Address+3</td> <td style="padding: 5px;">Vertical axis position of the end point</td> <td style="padding: 5px;"></td> </tr> <tr> <td style="padding: 5px;">Read Address+4</td> <td style="padding: 5px;">Color /Flicker (see note)</td> <td style="padding: 5px;"></td> </tr> <tr> <td style="padding: 5px;">Read Address+5</td> <td style="padding: 5px;">Flicker (see note)</td> <td style="padding: 5px;"></td> </tr> </tbody> </table> <p style="margin-top: 10px;">Note When you set Variable Color and Flicker to Yes, the address will be used for the variable color. The next address will be used for controlling the flicker.</p>	Variable Position	Yes	No	Read Address	Horizontal axis position of the start point	Color /Flicker (see note)	Read Address+1	Vertical axis position of the start point	Flicker (see note)	Read Address+2	Horizontal axis position of the end point		Read Address+3	Vertical axis position of the end point		Read Address+4	Color /Flicker (see note)		Read Address+5	Flicker (see note)	
Variable Position	Yes	No																				
Read Address	Horizontal axis position of the start point	Color /Flicker (see note)																				
Read Address+1	Vertical axis position of the start point	Flicker (see note)																				
Read Address+2	Horizontal axis position of the end point																					
Read Address+3	Vertical axis position of the end point																					
Read Address+4	Color /Flicker (see note)																					
Read Address+5	Flicker (see note)																					
Color	You can set the display color of the variable line object.																					
Width	The line width can be between 1 and 8 dots.																					
Read Format	The read format can be BCD, signed decimal, unsigned decimal or hexadecimal.																					
Line Style	<p>You can select the line style from below.</p> <div style="text-align: center; margin-top: 10px;">  </div>																					
Variable Position	Refer to the <i>Read Address</i> of this property.																					
Variable Color	Refer to the <i>Read Address</i> of this property.																					
Flicker	This option can flicker the object when the address that controls the flicker is ON.																					

■ Variable Rectangle Object

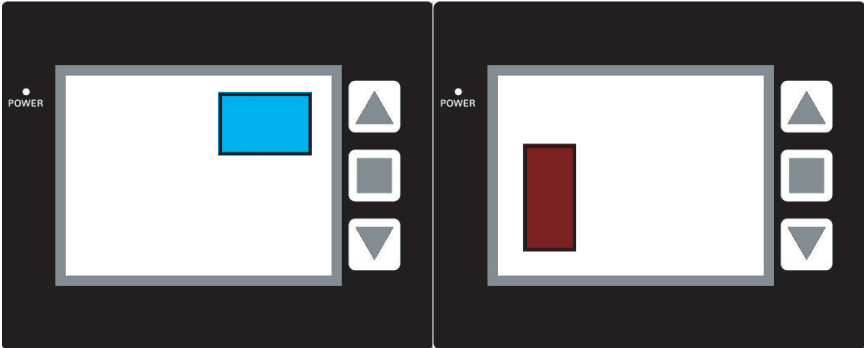
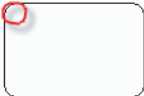
Property of Variable Rectangle Object																																					
<p>You can change the color, shape and display position of the variable rectangle object by the value of the read address.</p>																																					
																																					
Read Address	<p>Refer to 6-4-2 <i>Common Settings</i> for how to set read address.</p> <p>When you set Variable Position to Yes:</p> <table border="1" style="width: 100%; border-collapse: collapse; margin-bottom: 10px;"> <thead> <tr> <th style="width: 30%;">Variable Size</th> <th style="width: 35%;">Yes</th> <th style="width: 35%;">No</th> </tr> </thead> <tbody> <tr> <td>Read Address</td> <td>Horizontal axis position of the top left</td> <td>Horizontal axis position of the top left</td> </tr> <tr> <td>Read Address+1</td> <td>Vertical axis position of the top left</td> <td>Vertical axis position of the top left</td> </tr> <tr> <td>Read Address+2</td> <td>Object width</td> <td>Color /Flicker (see note)</td> </tr> <tr> <td>Read Address+3</td> <td>Object height</td> <td>Flicker (see note)</td> </tr> <tr> <td>Read Address+4</td> <td>Color /Flicker (see note)</td> <td></td> </tr> <tr> <td>Read Address+5</td> <td>Flicker (see note)</td> <td></td> </tr> </tbody> </table> <p>When you set Variable Position to No:</p> <table border="1" style="width: 100%; border-collapse: collapse; margin-bottom: 10px;"> <thead> <tr> <th style="width: 30%;">Variable Size</th> <th style="width: 35%;">Yes</th> <th style="width: 35%;">No</th> </tr> </thead> <tbody> <tr> <td>Read Address</td> <td>Horizontal radius</td> <td>Color /Flicker (see note)</td> </tr> <tr> <td>Read Address+1</td> <td>Vertical radius</td> <td>Flicker (see note)</td> </tr> <tr> <td>Read Address+2</td> <td>Color /Flicker (see note)</td> <td></td> </tr> <tr> <td>Read Address+3</td> <td>Flicker (see note)</td> <td></td> </tr> </tbody> </table> <p>Note When you set Variable Color and Flicker to Yes, the address will be used for the variable color. The next address will be used for controlling the flicker.</p>	Variable Size	Yes	No	Read Address	Horizontal axis position of the top left	Horizontal axis position of the top left	Read Address+1	Vertical axis position of the top left	Vertical axis position of the top left	Read Address+2	Object width	Color /Flicker (see note)	Read Address+3	Object height	Flicker (see note)	Read Address+4	Color /Flicker (see note)		Read Address+5	Flicker (see note)		Variable Size	Yes	No	Read Address	Horizontal radius	Color /Flicker (see note)	Read Address+1	Vertical radius	Flicker (see note)	Read Address+2	Color /Flicker (see note)		Read Address+3	Flicker (see note)	
Variable Size	Yes	No																																			
Read Address	Horizontal axis position of the top left	Horizontal axis position of the top left																																			
Read Address+1	Vertical axis position of the top left	Vertical axis position of the top left																																			
Read Address+2	Object width	Color /Flicker (see note)																																			
Read Address+3	Object height	Flicker (see note)																																			
Read Address+4	Color /Flicker (see note)																																				
Read Address+5	Flicker (see note)																																				
Variable Size	Yes	No																																			
Read Address	Horizontal radius	Color /Flicker (see note)																																			
Read Address+1	Vertical radius	Flicker (see note)																																			
Read Address+2	Color /Flicker (see note)																																				
Read Address+3	Flicker (see note)																																				
Width	The border line can be between 1 and 8 dots.																																				
Read Format	The read format can be from BCD, signed decimal, unsigned decimal or hexadecimal.																																				
Transparency	When you enable this option, only the object border will show and there is no color in the object. This will also disable the Foreground Color option.																																				
Corner Radius	<p>You can use the bevel size setting for the radius to round the corners. (The maximum setting value can change when the size of the object changes.)</p> 																																				

Property of Variable Rectangle Object	
Variable Position	Refer to the <i>Read Address</i> of this property.
Variable Size	Refer to the <i>Read Address</i> of this property.
Variable Color	Refer to the <i>Read Address</i> of this property.
Flicker	This option can flicker the object when the address that controls the flicker is ON.

■ Variable Ellipse Object

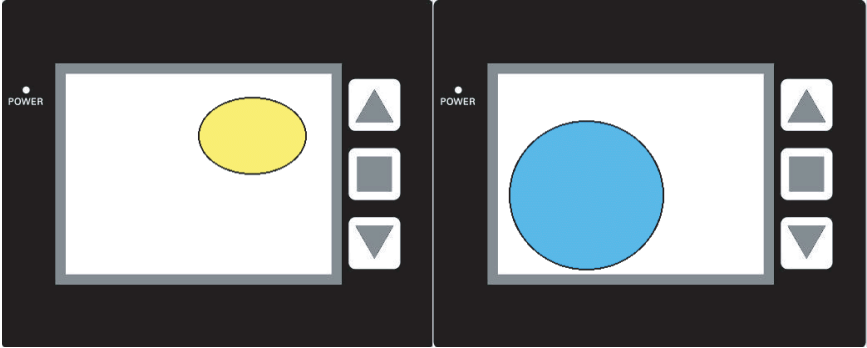
Property of Variable Ellipse Object																																					
<p>You can change the color, shape and display position of variable ellipse object by the value of the read address.</p>																																					
																																					
Read Address	<p>Refer to 6-4-2 <i>Common Settings</i> for how to set Read Address. When you set Variable Center Point to Yes:</p> <table border="1"> <thead> <tr> <th>Variable Size</th> <th>Yes</th> <th>No</th> </tr> </thead> <tbody> <tr> <td>Read Address</td> <td>Horizontal axis position of the center point</td> <td>Horizontal axis position of the center point</td> </tr> <tr> <td>Read Address+1</td> <td>Vertical axis position of the center point</td> <td>Vertical axis position of the center point</td> </tr> <tr> <td>Read Address+2</td> <td>Horizontal radius</td> <td>Color /Flicker (see note)</td> </tr> <tr> <td>Read Address+3</td> <td>Vertical radius</td> <td>Flicker (see note)</td> </tr> <tr> <td>Read Address+4</td> <td>Color /Flicker (see note)</td> <td></td> </tr> <tr> <td>Read Address+5</td> <td>Flicker (see note)</td> <td></td> </tr> </tbody> </table> <p>When you set Variable Center Point to No:</p> <table border="1"> <thead> <tr> <th>Variable Size</th> <th>Yes</th> <th>No</th> </tr> </thead> <tbody> <tr> <td>Read Address</td> <td>Horizontal radius</td> <td>Color /Flicker (see note)</td> </tr> <tr> <td>Read Address+1</td> <td>Vertical radius</td> <td>Read Address+3</td> </tr> <tr> <td>Read Address+2</td> <td>Color /Flicker (see note)</td> <td></td> </tr> <tr> <td>Read Address+3</td> <td>Flicker (see note)</td> <td></td> </tr> </tbody> </table> <p>Note When you set Variable Color and Flicker to Yes, the address will be used for the variable color. The next address will be used for controlling the flicker.</p>	Variable Size	Yes	No	Read Address	Horizontal axis position of the center point	Horizontal axis position of the center point	Read Address+1	Vertical axis position of the center point	Vertical axis position of the center point	Read Address+2	Horizontal radius	Color /Flicker (see note)	Read Address+3	Vertical radius	Flicker (see note)	Read Address+4	Color /Flicker (see note)		Read Address+5	Flicker (see note)		Variable Size	Yes	No	Read Address	Horizontal radius	Color /Flicker (see note)	Read Address+1	Vertical radius	Read Address+3	Read Address+2	Color /Flicker (see note)		Read Address+3	Flicker (see note)	
Variable Size	Yes	No																																			
Read Address	Horizontal axis position of the center point	Horizontal axis position of the center point																																			
Read Address+1	Vertical axis position of the center point	Vertical axis position of the center point																																			
Read Address+2	Horizontal radius	Color /Flicker (see note)																																			
Read Address+3	Vertical radius	Flicker (see note)																																			
Read Address+4	Color /Flicker (see note)																																				
Read Address+5	Flicker (see note)																																				
Variable Size	Yes	No																																			
Read Address	Horizontal radius	Color /Flicker (see note)																																			
Read Address+1	Vertical radius	Read Address+3																																			
Read Address+2	Color /Flicker (see note)																																				
Read Address+3	Flicker (see note)																																				
Color	You can set the display color of the variable ellipse object.																																				
Width	The line width can be between 1 and 8 dots.																																				
Read Format	The read format can be BCD, signed decimal, unsigned decimal or hexadecimal.																																				

Property of Variable Ellipse Object	
Transparency	When you enable this option, only the object border will show and there is no color in the object. This will also disable the Foreground Color option.
Variable Center Point	Refer to the <i>Read Address</i> of this property.
Variable Size	Refer to the <i>Read Address</i> of this property.
Variable Color	Refer to the <i>Read Address</i> of this property.
Flicker	This option can flicker the object when the address that controls the flicker is ON.

6-4-11 Input Objects

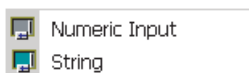

You can input a value or string in a specified address.



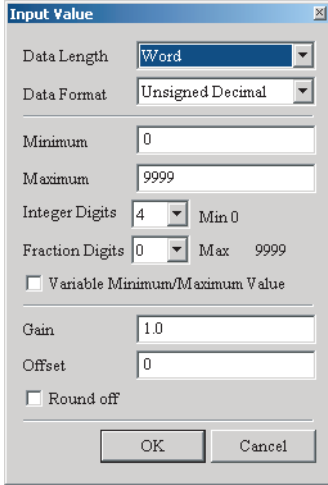

For details on functions common to all objects, refer to 6-4-2 *Common Settings*.

■ Numeric Input Object

Property of Numeric Input Object				
You can input the setting value directly on the screen. Press the object on the screen. A numeric keypad (TEN-KEY) will show. Input a setting value and press ENTER on a keypad. The PT will send the input setting value to the set address.				
Label Size Label Color	You can set the label size and label color. The label size can be between 8 and 64 pixels.			
Style	Standard 	Raised 	Sunken 	Transparency
Leading Zero	You can add or remove the leading zero to each value. The integral digits below are set to 4. (When YES is selected) (When NO is selected)			

Property of Numeric Input Object											
Detail											
	<table border="1"> <tr> <td>Data Length</td> <td>The data length can be word (16bits) or double word (32bits).</td> </tr> <tr> <td>Data Format</td> <td>You can select the data format from below: Word: BCD, signed decimal, unsigned decimal, hexadecimal, binary Double Word: BCD, signed decimal, unsigned decimal, hexadecimal, binary, float</td> </tr> <tr> <td>Minimum Maximum</td> <td>You can set the minimum and maximum value of the input setting range. These options executes the check of minimum and maximum values before the values are converted to the set gain and offset.</td> </tr> <tr> <td>Integer Digits Fraction Digits</td> <td>You can set the integer or fraction digits. The digit number will be an actual digit number only when the data format is selected as Float.</td> </tr> <tr> <td>Variable Minimum/Maximum Value</td> <td>When this option is selected, the Read Address+1 is the minimum value. Read Address+2 is the maximum value.</td> </tr> </table>	Data Length	The data length can be word (16bits) or double word (32bits).	Data Format	You can select the data format from below: Word: BCD, signed decimal, unsigned decimal, hexadecimal, binary Double Word: BCD, signed decimal, unsigned decimal, hexadecimal, binary, float	Minimum Maximum	You can set the minimum and maximum value of the input setting range. These options executes the check of minimum and maximum values before the values are converted to the set gain and offset.	Integer Digits Fraction Digits	You can set the integer or fraction digits. The digit number will be an actual digit number only when the data format is selected as Float.	Variable Minimum/Maximum Value	When this option is selected, the Read Address+1 is the minimum value. Read Address+2 is the maximum value.
Data Length	The data length can be word (16bits) or double word (32bits).										
Data Format	You can select the data format from below: Word: BCD, signed decimal, unsigned decimal, hexadecimal, binary Double Word: BCD, signed decimal, unsigned decimal, hexadecimal, binary, float										
Minimum Maximum	You can set the minimum and maximum value of the input setting range. These options executes the check of minimum and maximum values before the values are converted to the set gain and offset.										
Integer Digits Fraction Digits	You can set the integer or fraction digits. The digit number will be an actual digit number only when the data format is selected as Float.										
Variable Minimum/Maximum Value	When this option is selected, the Read Address+1 is the minimum value. Read Address+2 is the maximum value.										
Detail	<table border="1"> <tr> <td>Gain (a) Offset (b)</td> <td>You can gain and offset the display numeric value (y) by the equation $y = (a) \times (\text{Read Address value}) + (b)$. For example, if Gain value (a) is 2, Offset value (b) is 3, and the read address value is 4, the display numeric value will be $2 \times 4 + 3 = 11$.</td> </tr> <tr> <td>Round off</td> <td>If you select this option, the result (y) of the equation above can be rounded off.</td> </tr> </table>	Gain (a) Offset (b)	You can gain and offset the display numeric value (y) by the equation $y = (a) \times (\text{Read Address value}) + (b)$. For example, if Gain value (a) is 2, Offset value (b) is 3, and the read address value is 4, the display numeric value will be $2 \times 4 + 3 = 11$.	Round off	If you select this option, the result (y) of the equation above can be rounded off.						
Gain (a) Offset (b)	You can gain and offset the display numeric value (y) by the equation $y = (a) \times (\text{Read Address value}) + (b)$. For example, if Gain value (a) is 2, Offset value (b) is 3, and the read address value is 4, the display numeric value will be $2 \times 4 + 3 = 11$.										
Round off	If you select this option, the result (y) of the equation above can be rounded off.										
Display Asterisk (*)	If you select YES , the screen will show asterisks when you input values.										

■ String Input Object

Property of String Input Object				
Press a string input object to show a dialog box for inputting a string. This object writes the input string to the write address. The string is input or shown only ASCII format.				
Label Size Label Color	You can set the label size and label color. The label size can be between 8 and 64 points.			
Style	Standard	Raised	Sunken	Transparency
				

Property of String Input Object	
Characters Length	The character length can be between 1 and 28 characters. The default setting is 4 characters.
Display Asterisk (*)	If you select YES , the screen will show asterisks when you input characters.

6-4-12 Line Graph Objects



Refer to the 6-4-2 Common Settings on functions common to all objects.

■ Broken-Line Object

Property of Broken-Line Object			
<p>This object can show a broken-line chart of the read address values. Set the Line Number (1 to 4) in the property. Then click Value – Detail... to show the Line Setting Dialog Box, and set the Broken-Line chart setting. Example: If the Sample Number is 100 and Line Number is 4, the object will read the data of 100 X 4 = 400 words. When the Read Address is D0, the object will read from D0 to D399. See the Read Address allocation below. Line 1: D0 to D99 Line 2: D100 to D199 Line 3: D200 to D299 Line 4: D300 to D399 You must set the sample flag of the control block to read data and display the broken-line charts. Refer to the 6-6 Control Block and Status Block.</p>			
Style	Standard	Raised	Sunken
Line Number	The line number can be between 1 and 4 lines.		

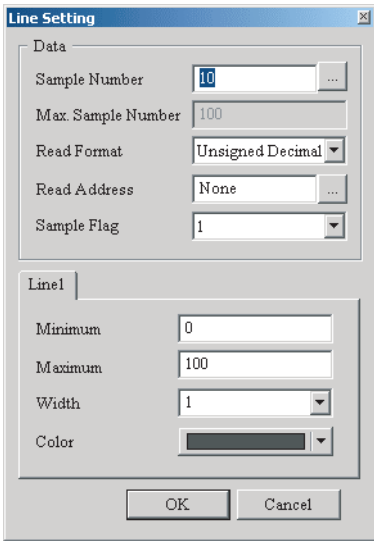
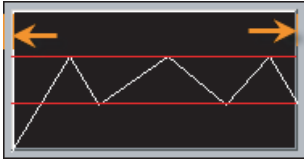
Property of Broken-Line Object	
Value	
Sample Number	<p>When the Sample Number is a constant, the Max. Sample Number option is disabled. The Max. Sample Number is specified as below:</p> <ul style="list-style-type: none"> • When the object style is Standard, the Max. Sample Number is the object width and the unit is dots. • When the object style is Raised or Sunken, the Max. Sample Number is the object width minus the border widths (the border size is always 7 dots). See the illustration below for the border widths.  <p>When the sample number is a variable value, the read address will be the sample number. If the variable value is more than the Max. Sample Number, the value will not exceed the Max. Sample Number that you set.</p>
Max. Sample Number	
Read Format	The read format can be BCD, signed decimal, unsigned decimal or hexadecimal.
Sample Flag	<p>You can select the number of the sample flag address. When the sample flag bit is ON, the data will be read and drawn. When the clear flag bit is ON, the graph will be cleared.</p> <p>The sample flag address is in the control block. Refer to 6-6 Control Block and Status Block.</p>
Minimum	<p>You can set the minimum and maximum value of the graph. If the value is more than the maximum value, the line will show the maximum value. If the value is less than the minimum value, the line will show the minimum value.</p>
Maximum	
Width	The line width can be between 1 and 8 dots.
Color	You can set the line color.

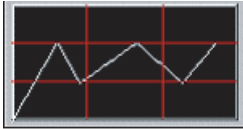
Property of Broken-Line Object	
Grid Color Partition Number	The illustration below shows that the Grid Color is red and the Partition Number is 3. 

■ X-Y Distribution Object

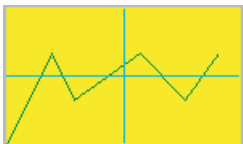
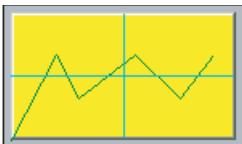
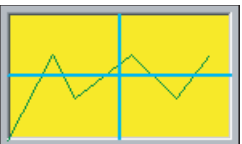
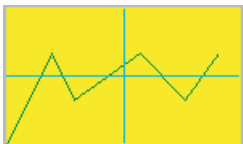
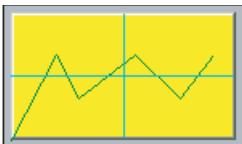
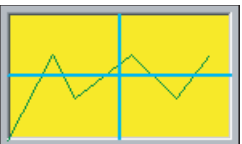
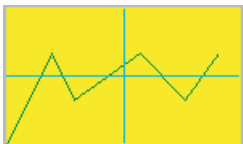
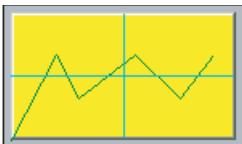
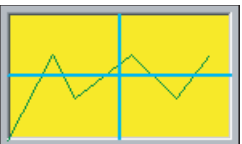
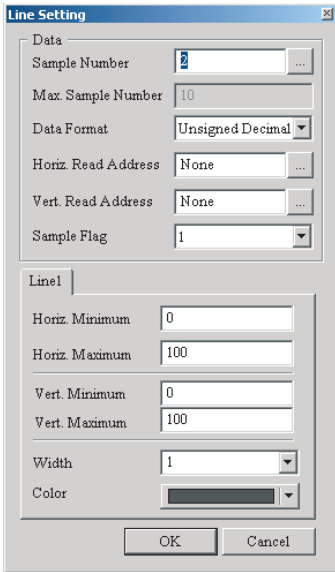
Property of X-Y Distribution Object									
<p>This object can show X and Y axes chart of the read address values.</p> <p>Set the Line Number (1 to 4) in the property. Then click Detail – Detail... to show the Line Setting Dialog Box, and set the X-Y distribution chart setting.</p> <p>Example:</p> <p>If the Sample Number is 100 and Line Number is 4, the object will use 100 X 4 X2= 800 words. When the Read Address of X axis is D0 and Y axis is D500, the object will read from D0 to D399 and from D500 to D899.</p> <p>See the Read Address allocation below.</p> <p>Line 1: X is D0 to D99, Y is D500 to D599</p> <p>Line 2: X is D100 to 199, Y is D600 to D699</p> <p>Line 3: X is D200 to D299, Y is D700 to D799</p> <p>Line 4: X is D300 to D399, Y is D800 to D899</p> <p>You must set the sample flag of the control block to read data and display the X-Y distribution. Refer to 6-6 Control Block and Status Block.</p>									
Style	<table border="1"> <thead> <tr> <th>Standard</th> <th>Raised</th> <th>Sunken</th> </tr> </thead> <tbody> <tr> <td></td> <td></td> <td></td> </tr> </tbody> </table>	Standard	Raised	Sunken					
Standard	Raised	Sunken							
									
Connect Two Points	When you select Yes , a straight line will connect each two points.								
Line Number	The line number can be between 1 and 4 lines.								
Detail									

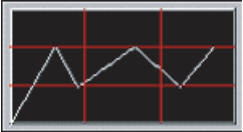
Property of X-Y Distribution Object		
Detail	<p>Sample Number Max. Sample Number</p> <p>When the Sample Number is a constant, the Max. Sample Number option is disabled. The Max. Sample Number is specified as below:</p> <ul style="list-style-type: none"> • When the object style is Standard, the Max. Sample Number is the object width and the unit is dots. • When the object style is Raised or Sunken, the Max. Sample Number is the object width minus the border widths (the border size is always 7 dots). See the illustration below for the border widths.  <p>When the sample number is a variable value, the read address will be the sample number. If the variable value is more than the Max. Sample Number, the value will not exceed the Max. Sample Number that you set.</p>	
	Data Format	The read format can be BCD, signed decimal, unsigned decimal or hexadecimal.
	Horiz. Read Address	You can set the read address of the horizontal (X) axis position.
	Vert. Read Address	You can set the read address of the vertical (Y) axis position.
	Sample Flag	You can select the number of the sample flag address. When the sample flag bit is ON, the data will be read and drawn. When the clear flag bit is ON, the graph will be cleared. The sample flag address is in the control block. Refer to 6-6 Control Block and Status Block.
	Horiz. Minimum Horiz. Maximum	You can set the minimum and maximum value of the horizontal (X) axis.
	Vert. Minimum Vert. Maximum	You can set the minimum and maximum value of the vertical (Y) axis.
	Width	You can set the line width. The line width can be between 1 and 8 dots.
	Color	You can set the line color.
Grid Color Horiz. Line Number Vert. Line Number	<p>The illustration below shows that the Grid Color is red and the both of Horizontal Line Number and Vertical Line Number are 2.</p> 	

6-4-13 Data Log Objects

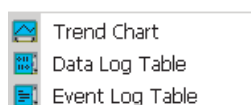

The data log objects can show data logs in graph and table formats. You must use this object with **Data Log Setting**. Refer to 6-2-4 PT Menu for the setting. Refer to the 6-4-2 Common Settings on functions common to all objects.

■ Trend Chart Object

Property of Trend Chart Object	
The trend chart object can show data logs.	
Line Number	The line number can be between 1 and 8 lines.
Value	
Logging Buffer	You can select the data log buffer number. The number is the same as the line number of Data Log Setting Dialog Box.
Data Format	The data format can be BCD, signed decimal, unsigned decimal, hexadecimal or float. The data length is word. When you select Float , you must set more than 2 words in the Data Length Field of Data Log Setting Dialog Box.
Minimum	You can set the minimum and maximum value of the trend chart. If the value is more than the maximum value, the line will show the maximum value. If the value is less than the minimum value, the line will show the minimum value.
Maximum	
Integral Digits	You can set the integer or fraction digits. The digit number will be an actual digit number only when the data format is selected as Float .
Fraction Digits	
Data Log Buffer Setup	Click the Data Log Buffer Setup Button to open the Data Log Setting Dialog Box. You can also select PT Menu – Data Log Setting .
Time/Date	
Time Format	The time format can be HH:MM:SS or HH:MM.

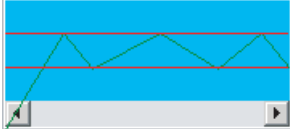
Property of Trend Chart Object		
Value	Date Format	The date format can be MM/DD/YY, DD/MM/YY or DD.MM.YY.
	Color	You can set the text color of time and date. This option will be enabled when the Time Format or Date Format is selected.
	Curve (No.1 ~ 8)	
	Enable	If this option is selected, you can enable the line options.
	Data No.	You must set the data number to read the data log. For example, if the Data Length option in the Data Log Setting Dialog Box is 3 words, you can select the Data No. from 0 to 2. When you select 1, the line 1 reads the value of the Read Address+1 . Note If the data format is Float and the number of the Data Length is an odd number, you must select an even number as the Data No.
	Width	The line width can be between 1 and 8 dots.
	Color	You can set the line color.
Grid Color Partition Number	The illustration below shows that the grid color is red and the Partition Number is 3. 	

Example of data log trend chart object:

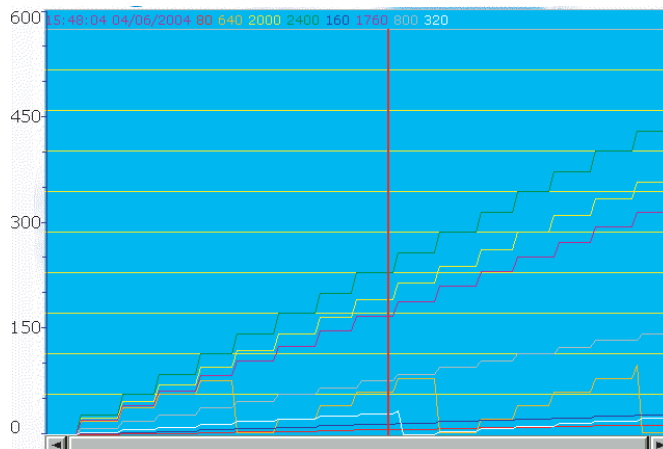

■ Data Log Table Object

Property of Data Log Table Object	
<p>The data log table object can show data logs in table format. When you input the read address in the Data Log Setting Dialog Box, the data length must be between 1 and 8 words. The Data No. of each Data Tab in the Data Log Detail Dialog Box will change with this value. For example, if the value of Data Length is 5, the Data No. selection will also be 5.</p>	
Column	The number of the display data items can be between 1 and 8.
Value	
Logging Buffer	You can select the data log buffer number. The number is the same as the line number of Data Log Setting Dialog Box.
Data Log Buffer Setup	Click the Data Log Buffer Setup Button to open the Data Log Setting Dialog Box. You can also select PT Menu – Data Log Setting...
Time/Date	
Time Format	The time format can be HH:MM:SS or HH:MM.
Date Format	The date format can be MM/DD/YY, DD/MM/YY or DD.MM.YY.
Color	You can set the text color of time and date. This option will be enabled when the Time Format or Date Format is selected.
Data (No. 1 to 8)	
Data Length	The data length can be word (16bits) or double word (32bits).
Data Format	The data format can be BCD, signed decimal, unsigned decimal, hexadecimal or float.

Property of Data Log Table Object		
Value	Data No.	You must set the data number to read the data log. For example, if the Data Length option in the Data Log Setting Dialog Box is 3 words, you can select the Data No. from 0 to 2. When you select 1, the line 1 reads the value of the Read Address+1 . Note If the data format is Float and the number of the Data Length is an odd number, you must select an even number as the Data No.
	Color	You can set the display text color of the data.
	Integer Digits Fraction Digits	You can set the integer or fraction digits. The digit number will be an actual digit number only when the data format is selected as Float.
	Leading Zero	You can add or remove the leading zero to each value. For example, when Leading Zero option is enabled and the integral digits are set to 4, the display value will be 0001 instead of 1.

Example of data log table object:

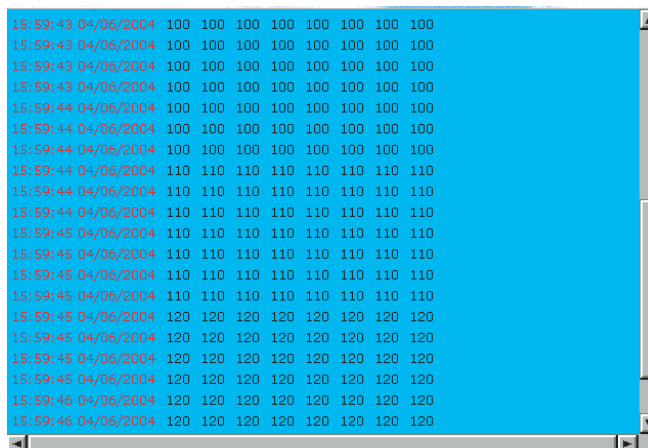

■ Event Log Table Object

Property of Event Log Table Object	
The event log table object can show the event logs in table format. When the state changes, the specified message also changes.	
Data Length	The data length can be word or LSB.
Read Format	The read format can be BCD, signed decimal, unsigned decimal or hexadecimal. This option is available only when the data length is word.
Add/Remove State	You can set the number of states of the object. The setting range will change by the data length. Word: 256 states LSB: 16 states

Property of Event Log Table Object															
Detail															
	<table border="1"> <tr> <td>Logging Buffer</td> <td>You can select the data log buffer number. The number is the same as the line number of Data Log Setting Dialog Box.</td> </tr> <tr> <td>Data No.</td> <td>You must set the data number to read the event log. For example, if the Data Length option in the Data Log Setting Dialog Box is 3 words, the Data No. can be between 0 and 2. When you select 1, the object reads the value of the Read Address+1.</td> </tr> <tr> <td>Data Log Buffer Setup</td> <td>Click the Data Log Buffer Setup Button to open the Data Log Setting Dialog Box. You can also select PT Menu – Data Log Setting...</td> </tr> <tr> <td colspan="2">Time/Date</td> </tr> <tr> <td>Time Format</td> <td>The time format can be HH:MM:SS or HH:MM.</td> </tr> <tr> <td>Date Format</td> <td>The date format can be MM/DD/YY, DD/MM/YY or DD.MM.YY.</td> </tr> <tr> <td>Color</td> <td>You can set the text color of Time/Date. This option will be enabled when the Time Format or Date Format is selected.</td> </tr> </table>	Logging Buffer	You can select the data log buffer number. The number is the same as the line number of Data Log Setting Dialog Box.	Data No.	You must set the data number to read the event log. For example, if the Data Length option in the Data Log Setting Dialog Box is 3 words, the Data No. can be between 0 and 2. When you select 1, the object reads the value of the Read Address+1.	Data Log Buffer Setup	Click the Data Log Buffer Setup Button to open the Data Log Setting Dialog Box. You can also select PT Menu – Data Log Setting...	Time/Date		Time Format	The time format can be HH:MM:SS or HH:MM.	Date Format	The date format can be MM/DD/YY, DD/MM/YY or DD.MM.YY.	Color	You can set the text color of Time/Date. This option will be enabled when the Time Format or Date Format is selected.
	Logging Buffer	You can select the data log buffer number. The number is the same as the line number of Data Log Setting Dialog Box.													
	Data No.	You must set the data number to read the event log. For example, if the Data Length option in the Data Log Setting Dialog Box is 3 words, the Data No. can be between 0 and 2. When you select 1, the object reads the value of the Read Address+1.													
	Data Log Buffer Setup	Click the Data Log Buffer Setup Button to open the Data Log Setting Dialog Box. You can also select PT Menu – Data Log Setting...													
	Time/Date														
	Time Format	The time format can be HH:MM:SS or HH:MM.													
	Date Format	The date format can be MM/DD/YY, DD/MM/YY or DD.MM.YY.													
Color	You can set the text color of Time/Date. This option will be enabled when the Time Format or Date Format is selected.														

Example of event log table object:

- | | | |
|----|---------|----------------------------------|
| 1. | D1000=0 | X Axis servo position ready |
| 2. | D1000=1 | Y Axis servo position ready |
| 3. | D1000=2 | Z Axis servo position ready |
| 4. | D1000=3 | Rotation Inverter Position ready |
| 5. | D1000=4 | Motion controller home ready |
| 6. | D1000=5 | Water motor over load |
| 7. | D1000=6 | Oil pump over load |

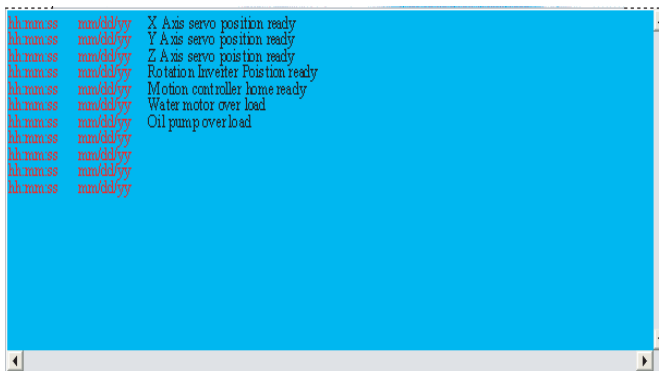

6-4-14 Alarm Objects

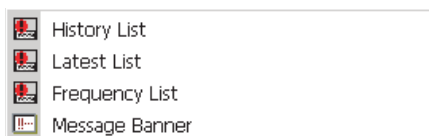

The alarm objects can show the alarm messages in table format. You must use these objects with **Alarm Setting**. Refer to 6-2-4 PT Menu for the setting. For details on functions common to all objects, refer to 6-4-2 Common Settings.

■ History List Object

Property of History List Object									
The generate history/cancel history for the set alarm will be displayed in chronological order in list format. The generate history items will be shown with O's and the cancel history items will be shown with X's.									
Detail									
	<table border="1"> <tr> <td>Time Format</td> <td>The time format can be HH:MM:SS or HH:MM.</td> </tr> <tr> <td>Date Format</td> <td>The date format can be from MM/DD/YY, DD/MM/YY or DD.MM.YY.</td> </tr> <tr> <td>Alarm Number</td> <td>This option can show the alarm number in the history list object. The alarm number will always be in front of the alarm message. The Alarm Number will be set in the Alarm Setting Dialog Box.</td> </tr> <tr> <td>Color</td> <td>You can set the text color of time and date. This option will be active when the Time Format or Date Format is selected.</td> </tr> </table>	Time Format	The time format can be HH:MM:SS or HH:MM.	Date Format	The date format can be from MM/DD/YY, DD/MM/YY or DD.MM.YY.	Alarm Number	This option can show the alarm number in the history list object. The alarm number will always be in front of the alarm message. The Alarm Number will be set in the Alarm Setting Dialog Box.	Color	You can set the text color of time and date. This option will be active when the Time Format or Date Format is selected.
	Time Format	The time format can be HH:MM:SS or HH:MM.							
	Date Format	The date format can be from MM/DD/YY, DD/MM/YY or DD.MM.YY.							
	Alarm Number	This option can show the alarm number in the history list object. The alarm number will always be in front of the alarm message. The Alarm Number will be set in the Alarm Setting Dialog Box.							
Color	You can set the text color of time and date. This option will be active when the Time Format or Date Format is selected.								

Example of history list object

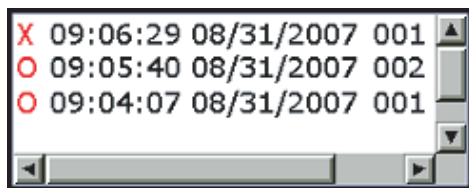

1. Alarm No. 001 occurred at August 31, 2007 09:04:07
2. Alarm No. 002 occurred at August 31, 2007 09:05:40
3. Alarm No. 001 released at August 31, 2007 09:06:29

■ Latest List Object





Property of Latest List Object	
The present alarms will be shown in list format.	
Detail	<p>The 'Alarm Detail' dialog box for the Latest List Object. It features a 'Status Display' section with three options: 'Time Format' (unchecked, dropdown set to 'hh:mm:ss'), 'Date Format' (unchecked, dropdown set to 'mm/dd/yy'), and 'Alarm Number' (checked). There is also a 'Color' dropdown menu. 'OK' and 'Cancel' buttons are at the bottom.</p>
Time Format	The time format can be HH:MM:SS or HH:MM.
Date Format	The date format can be from MM/DD/YY, DD/MM/YY or DD.MM.YY.
Color	You can set the text color of time and date. This option will be active when the Time Format or Date Format is selected.

■ Frequency List Object

Property of Frequency List Object	
The alarm ON frequency (number of alarms) will be shown in the order of the alarms, in list format.	
Detail	<p>The 'Alarm Detail' dialog box for the Frequency List Object. It features a 'Status Display' section with four options: 'Time Format' (unchecked, dropdown set to 'hh:mm:ss'), 'Date Format' (unchecked, dropdown set to 'mm/dd/yy'), 'Alarm Number' (unchecked), and 'Display For Counting Zero Too' (checked). There is also a 'Color' dropdown menu. 'OK' and 'Cancel' buttons are at the bottom.</p>
Time Format	The time format can be HH:MM:SS or HH:MM.

Property of Frequency List Object		
Detail	Date Format	The date format can be from MM/DD/YY, DD/MM/YY or DD.MM.YY.
	Alarm Number	This option can show the alarm number in the frequency list object. The alarm number will always be in front of the alarm message. The Alarm Number will be set in the Alarm Setting Dialog Box.
	Display for Counting Zero Too	If this option is selected, the alarm frequency list object will show the message when the alarm message occurrence is zero.
	Color	You can set the text color of time and date. This option will be active when the Time Format or Date Format is selected.

■ Message Banner Object

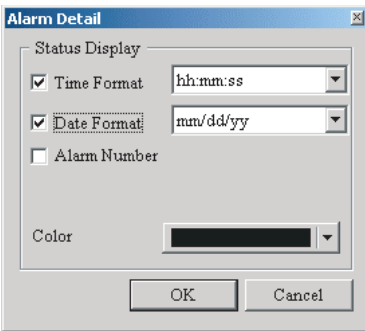
Property of Message Banner Object				
The present alarms will be shown in a single line of scrolling text.				
Style	Standard	Raised	Sunken	Transparency
				
Movement Distance	You can set the movement distance of the banner. The range can be between 1 and 50 dots.			
Interval (ms)	The interval time of the movement distance can be between 50 and 3000 ms.			
Value				
	Time Format	The time format can be HH:MM:SS or HH:MM.		
	Date Format	The date format can be from MM/DD/YY, DD/MM/YY or DD.MM.YY.		
	Alarm Number	This option can show the alarm number in the message banner object. The alarm number will always be in front of the alarm message. The Alarm Number will be set in the Alarm Setting Dialog Box.		
	Color	You can set the text color of time and date. This option will be active when the Time Format or Date Format is selected.		

6-4-15 Fixed Objects

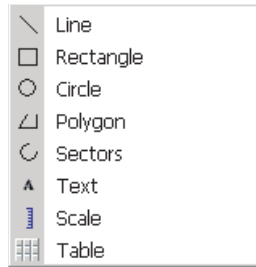

The users can make many graphics objects by use of the fixed objects. Refer to the 6-4-2 Common Settings on functions common to all objects.

■ Line Object

Property of Line Object	
You can draw line objects.	
<p>Line direction</p>	<p>Line width (1 to 8)</p>
Line Color	You can set the line color of the object.
Line Width	The line width can be between 1 and 8 dots.
Line Style	You can select the line styles from below.



■ Rectangle Object

Property of Rectangle Object	
You can draw rectangle objects.	
Line Color	You can set the line color of the object.
Line Width	The line width can be between 1 and 8 dots.
Transparency	When you enable this option, only the object border will show and there is no color in the object. This will also disable the Foreground Color option.
Corner Radius	You can use the bevel size setting for the radius to round the corners. (The maximum setting value can change when the size of the object changes.)

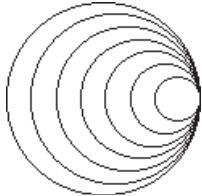
■ Circle Object

Property of Circle Object	
You can draw circle objects.	
Line Color	You can set the line color of the object.
Line Width	The line width can be between 1 and 8 dots.
Transparency	<p>The outside area of a circle is always in transparent color.</p> <p>When you select Yes, the foreground color will be in transparent color and the object will show the border line only. If there are other objects below this object, they will show up and can be viewed on the screen.</p> <p>See the illustrations below.</p> <div style="display: flex; justify-content: space-around; align-items: center;"> <div style="text-align: center;">  <p><i>Transparency option is No</i></p> </div> <div style="text-align: center;">  <p><i>Transparency option is Yes</i></p> </div> </div>

■ Polygon Object

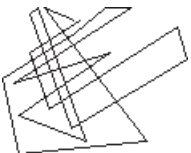
Property of Polygon Object	
You can draw polygon objects.	
Line Color	You can set the line color of the object.
Foreground Color	<p>You can set the display color of the object. See the illustrations below.</p> <div style="display: flex; justify-content: space-around; align-items: center;">   </div> <p>The foreground color is blue. The foreground color is light blue.</p>
Line Width	The line width can be between 1 and 8 dots.
Transparency	<p>The outside area of a polygon is always in transparent color.</p> <p>When you select Yes, the foreground color will be in transparent color and the object will show only with the border line. This option will also disable the Foreground Color option. If there are other objects below this object, they will show up and can be viewed on the screen.</p> <p>See the illustrations below.</p> <div style="display: flex; justify-content: space-around; align-items: center;"> <div style="text-align: center;">  <p><i>Transparency option is No.</i></p> </div> <div style="text-align: center;">  <p><i>Transparency option is Yes.</i></p> </div> </div>

■ Sectors Object

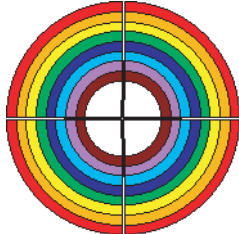
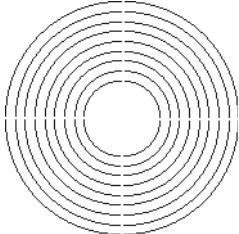
Property of Sectors Object	
You can draw sectors objects.	
Line Color	You can set the line color of the object.
Line Width	The line width can be between 1 and 8 dots.
Arc	<p>When you select Yes, the object will become an arc. This option will also disable the Foreground Color option. When you select No, the object will become a sector.</p> <div style="display: flex; justify-content: space-around; align-items: center;"> <div style="text-align: center;">  <p>Arc option is No.</p> </div> <div style="text-align: center;">  <p>Arc option is Yes</p> </div> </div>

■ Text Object

Property of Sectors Object	
You can draw text objects.	
Label Size	The label size can be between 8 and 64.
Foreground Color Label Color	<p>You can set the color of the text frame and label color. See the illustration below.</p> <p>The Foreground Color is blue. The Label Color is white.</p> <div style="text-align: center; margin: 10px 0;">  </div>
Transparency	When you select Yes , the foreground color will be in transparent color and the object will show the label text only. This option will also disable the Foreground Color option.

■ Scale Object

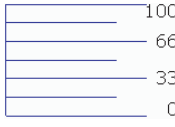
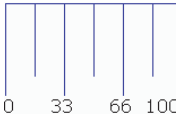
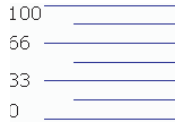
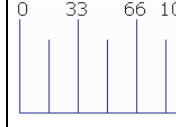
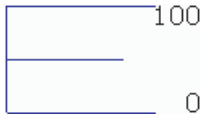
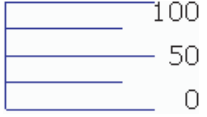
Property of Scale Object				
You can draw scale objects.				
Label Size	You can set the label size and label color.			
Label Color	The label size can be between 8 and 64.			
Style	<p>Standard</p> 	<p>Rotation 90</p> 	<p>Rotation 180</p> 	<p>Rotation 270</p> 
Label Display	This option can show the label display next to the scale.			
Main Scale	See the illustrations below.			
	 <p>The main scale is 2.</p>	 <p>The main scale is 3.</p>		

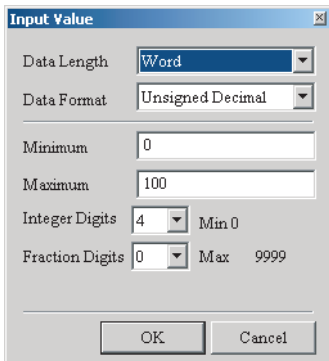
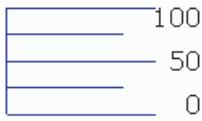
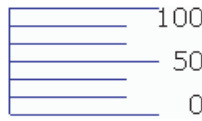
Property of Scale Object	
Value	
Data Length	The data length can be word (16bits) or double word (32bits).
Date Format	The data format can be BCD, signed decimal or unsigned decimal.
Minimum	You can set the minimum and maximum values of the scale range.
Maximum	
Integer Digits	You can set the integer and fraction digits.
Fraction Digits	
Scale Color	You can set the scale color of the object.
Sub Scale Number	<p>See the illustrations below.</p> <div style="display: flex; justify-content: space-around;"> <div style="text-align: center;">  <p>The main scale number is 3. The sub scale number is 1.</p> </div> <div style="text-align: center;">  <p>The main scale number is 3. The sub scale number is 2.</p> </div> </div>

■ Table Object

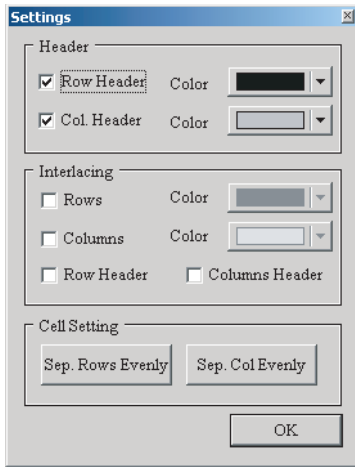
Property of Table Object		
You can draw table objects.		
Detail Setup		
Header	Row Header	This option can set the color of the first row of the table.
	Col. Header	This option can set the color of the first column of the table.

Property of Table Object			
Detail Setup	Interlacing	Rows	This option can set the color of the interlacing rows of the table.
		Columns	This option can set the color of the interlacing columns of the table.
		Row Header	This option can set the color of the interlacing row header of the table.
		Columns Header	This option can set the color of the interlacing column header of the table.
	Cell Setting	Sep. Rows Evenly	You can distribute the rows of the table evenly.
		Sep. Col Evenly	You can distribute the columns of the table evenly.
Grid Color	You can set the grid color.		
Number of Rows	The number of rows can be between 1 and 99 rows.		
Number of Columns	The number of columns can be between 1 and 99 columns.		

6-5 Macro Function

6-5-1 Macro Types

Macro is the function executed by a basic program. With this Macro function, the NP-series PTs can process screen display or data, which were processed on hosts. Thus, the load on hosts decreases. To make sure that Macro is correct, you can use Test function on a computer to do a Macro test.

■ Macro Types

Macro		Description
Macro Set with Project	Startup Macro	The PT executes the Startup Macro only one time when the PT status up.
	Project Resident Macro	The PT executes the Project Resident Macro again and again when the PT starts up.
	Project Periodic Macro	The PT executes the Project Periodic Macro at the specified interval while the PT operates.
Macro Set with Screen	Start Macro	The PT executes Start Macro to show screens. The PT draws objects on the screen after the PT executes this macro.
	End Macro	The PT executes End Macro to close screens. If you use this macro to switch screens, the PT executes the Start Macro for the destination screen only after the PT executes the End Macro for the current screen.
	Screen Periodic Macro	The PT executes the Screen Periodic Macro at the specified interval while the PT shows screens.
Macro Set with Object (Button)	ON Macro	The PT executes the ON Macro only one time to turn ON a bit of an object.
	OFF Macro	The PT executes the OFF Macro only one time to turn OFF a bit of an object.
	Touch ON Macro	The PT executes the Touch ON Macro the instant the user press the object.
	Touch OFF Macro	The PT executes the Touch OFF Macro the instant the user press the object.
Other	Submacro	The Sub-macro is a subroutine. It is possible to: <ul style="list-style-type: none"> • Call the Sub-macro from each macro, • Register 512 Sub-macros in one project, and • Give a name.

■ Restrictions

- Each macro can have a maximum of 512 lines.
- Each line can have a maximum of 128 bytes.
- Make sure that infinite loops do not occur. (Example: You cannot stop a program).
- Variables cannot be used to specify addresses within macros.

■ Sub-macro

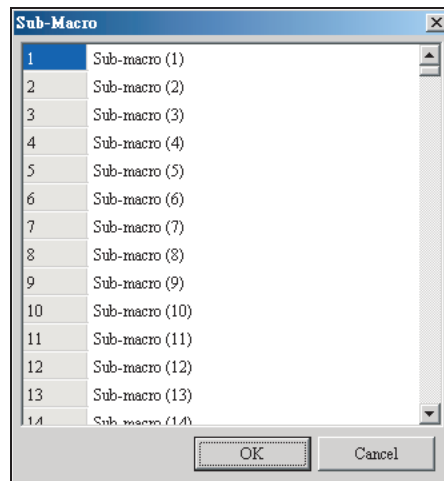

To comment each macro, you can use the Sub-macro function. Thus the management, maintenance and operation are easy.

The initial name of all sub-macros is Sub-macro (n) (n = 1 to 512).

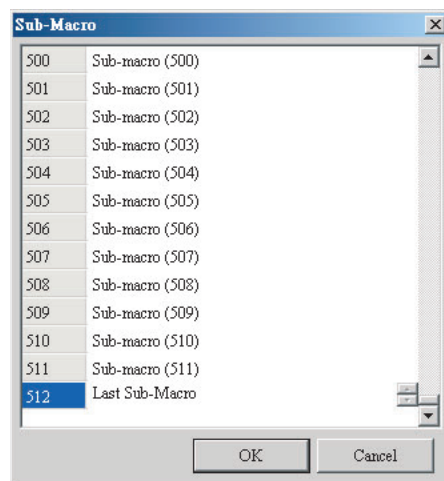

The left field shows the Sub-macro numbers.

To use the Sub-macro, you can write "CALL n (n = 1 to 512)".

6-5-2 Editing Macro

1. Selecting Macro Commands

- 1,2,3...
1. Select a macro from the menu bar or property. The macro editing window shows.
 2. Click the Macro Wizard Icon. The **Macro Command** Dialog Box shows.
 3. Click the Command Button or **Command** Menu in the **Macro Command** Dialog Box.
 4. Select a command.
 5. Edit a macro.

2. Macro Editing Window and Macro Command Dialog Box

1,2,3... 1. Macro Editing Window

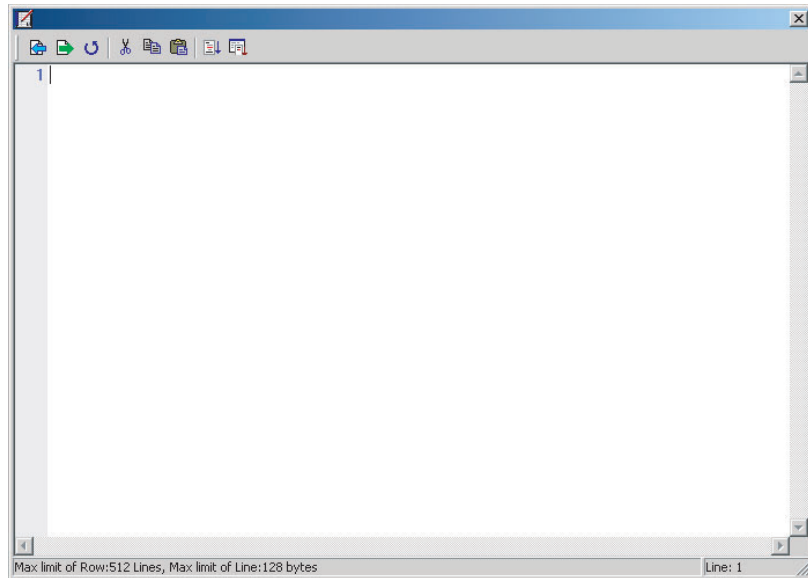

Note The number on the left is the line number.

Toolbar of Macro Editing Window

- Import Macro



This command imports macro files. You can reuse these files when you connect to different hosts. This decreases the time to edit macros. To open a macro file, click the Import Macro icon. You can see this dialog box.

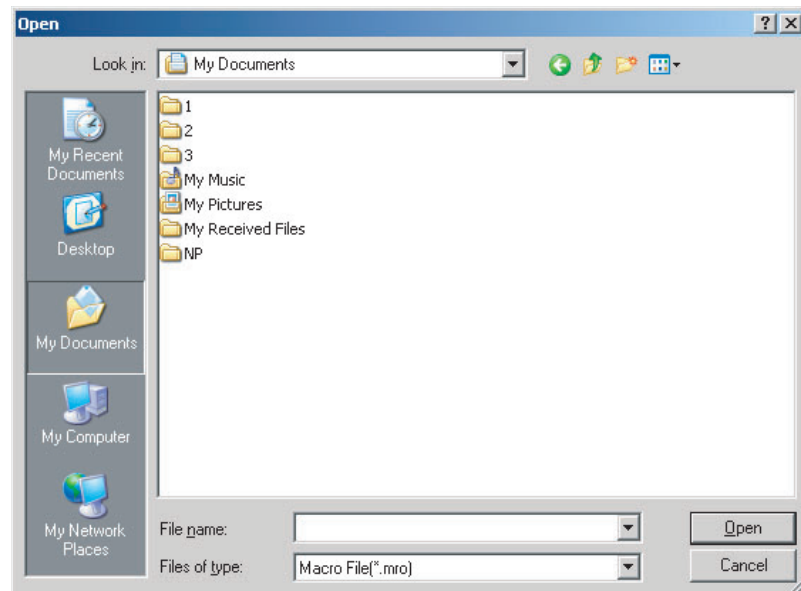

- Export Macro



This command saves created macro files. It is possible to give a new name to tell the difference between the new file and others.

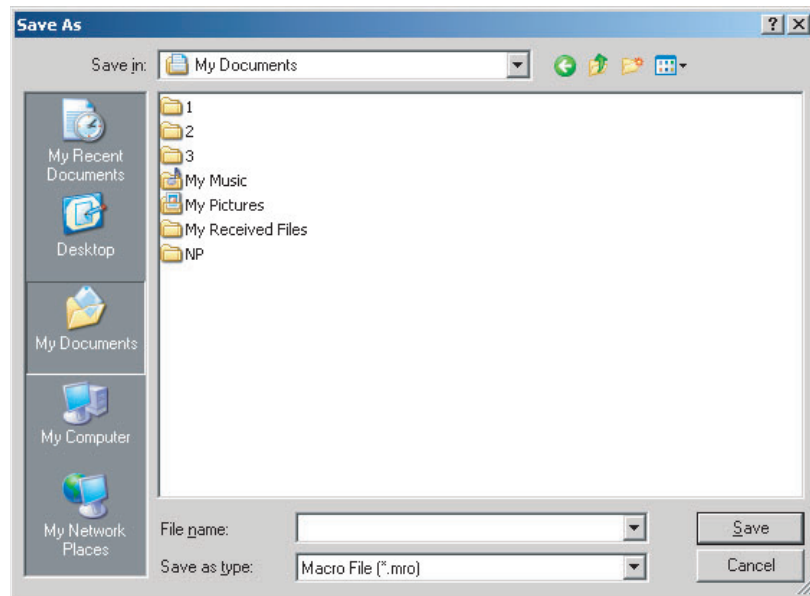

- Update Macro



This function updates macros.

- Cut



This command cuts macros.

- Copy



This command copies macros.

- Paste



This command pastes macros.

- Syntax Check



This function makes sure that the macro syntax is correct.

- Macro Wizard



This command shows the **Macro Command** Dialog Box. You can use this dialog box to edit macro. The macro commands are put in brackets when you use host addresses. This tells you the difference between the commands and the Internal Memory.

2. Macro Command Dialog Box

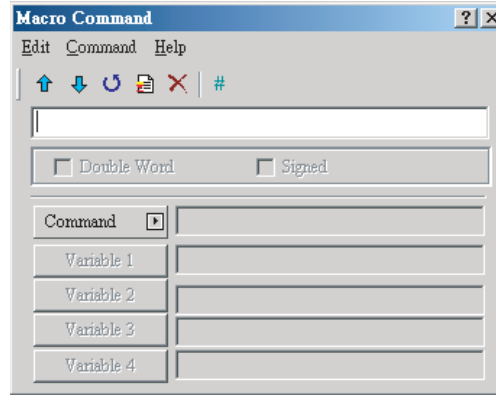

■ Macro Command Dialog Box

- Previous



This command moves up the selected line by one line. The above lines will also move up by one line.

- Next



This command moves down the selected line by one line. The lines below will also move down by one line.

- Update



This function updates the macro. If you do not use this function after you edit a macro, changes are not updated. With this function, you can know if it is necessary to change the macro or not. If the macro is not updated, you need to edit the macro again.

- Insert



This command inserts a macro between two lines. The lines below will move down by one line.

- Delete



This command deletes the selected line. The lines below will move up by one line.

- Comment



To write comments in programs, you can put the sharp symbol (#) in front of sentences. The sentences from the sharp symbol to the end are comments.

- Input field



You can use keys to edit macro in the input field.
To edit the macro,

1. Input macros in the input field.

2. Update the macros, or click the Enter key. The NP-Designer changes the macro to a correct format.

If there is an error, a warning dialog box shows.

There is no limit in spaces between operand and operation symbol.

• Command

To edit macro, you can use the commands.

To use commands and equations,

- Input directly.
- Select from the menu or **Command** Button.

6-5-3 Macro Operation

■ Definition

- BYTE 8-bit data. You can use it to show 00 to FF of hexadecimal system.
- WORD 16-bit data. Word is made up of continuous 2 bytes. For example b15 to b0. You can use it to show 0000 to FFFF of hexadecimal system.
- DWORD, DW 32-bit data. Double word is made up of continuous 2 words. For example b31 to b0. You can use it to show 00000000 to FFFFFFFF of hexadecimal system.
- Signed A signed value is a numeric value with polarity. You will usually see a 'plus' sign in front of a positive number, and a 'minus' sign in front of a negative number.

■ Arithmetic Operation

There are two Arithmetic Operations, which include Integer Operation and Float Operation.

Each operand can be the internal memory or constant. The operands that store output results must be the internal memory. For details, refer to this table and examples below.

	Command	Equation	Description	Remarks
Integer Operation	+	Var1=Var2 + Var3	Addition	These commands store the calculated result as signed or unsigned WORD and DWORD. When the data is more than the length of specified unit, these commands discard the data out of range.
	-	Var1=Var2 - Var3	Subtraction	
	*	Var1 = Var2 * Var3	Multiplication	
	/	Var1= Var2 / Var3	Division	
	%	Var1= Var2 % Var	Get Remainder	
	ADDSUMW	Var1 = ADDSUMW(Var2, Var3)	Sum	
	=	Var1 = Var2	Assignment	
Float Operation	FADD	Var1=FADD(Var2, Var3)	Addition	Float Operation is the operation of signed 32-bit data.
	FSUB	Var1=FSUB(Var2, Var3)	Subtraction	
	FMUL	Var1=FMUL(Var2, Var3)	Multiplication	
	FDIV	Var1=FDIV(Var2, Var3)	Division	
	FMOD	Var1=FMOD(Var2, Var3)	Get Remainder	

+, FADD

Addition

Equation: $Var1 = Var2 + Var3[(Signed | DW)]$

$Var1 = FADD(Var2, Var3) (Signed DW)$

This command adds Var2 and Var3, and stores the added result in Var1.

Example:

Adds the value in the internal memory \$2 and 1.

$\$2 = \$2 + 1$

Adds the value in the internal memory \$1 and \$2, and stores the total in the address \$3.

$\$3 = \$2 + \$1$

Adds the value in the internal memory \$4 and 1.9.

$\$4 = \text{FADD}(\$4, 1.9)$ (Signed DW)

Combines the float values in the internal memory \$4 and \$6, and stores the total in the address \$8.

$\$8 = \text{FADD}(\$4, \$6)$ (Signed DW)

-, FSUB

Subtraction

Equation: $\text{Var1} = \text{Var2} - \text{Var3}[(\text{Signed} \mid \text{DW})]$

$\text{Var1} = \text{FSUB}(\text{Var2}, \text{Var3})$ (Signed DW)

This command subtracts Var3 from Var2, and stores the subtracted result in Var1.

Example:

Subtracts 1 from the value in the internal memory \$2.

$\$2 = \$2 - 1$

Subtracts the value in the internal memory \$1 from the value in the internal memory \$2, and stores the result in the internal memory \$3.

$\$3 = \$2 - \$1$

Subtracts 1.9 from the value in the internal memory \$4.

$\$4 = \text{FSUB}(\$4, 1.9)$ (Signed DW)

Subtracts the float value in the internal memory \$6 from the float value in the internal memory \$4, and stores the result in the internal memory \$8.

$\$8 = \text{FSUB}(\$4, \$6)$ (Signed DW)

***, FMUL**

Multiplication

Equation: $\text{Var1} = \text{Var2} * \text{Var3}[(\text{Signed} \mid \text{DW})]$

$\text{Var1} = \text{FMUL}(\text{Var2}, \text{Var3})$ (Signed DW)

This command multiplies Var2 by Var3, and stores the result in Var1.

Example:

Multiplies the value in the internal memory \$2 by 2.

$\$2 = \$2 * 2$

Multiplies the value in the internal memory \$2 by \$1, and stores the result in the address \$3.

$\$3 = \$2 * \$1$

Multiplies the value in the internal memory address \$4 by 1.5.

$\$4 = \text{FMUL}(\$4, 1.5)$ (Signed DW)

Multiplies the float value in the internal memory \$4 by \$6, and stores the result in \$8.

\$8 = FMUL(\$4, \$6) (Signed DW)

/, FDIV

Division

Equation: $\text{Var1} = \text{Var2} / \text{Var3}[(\text{Signed} | \text{DW})]$

$\text{Var1} = \text{FDIV}(\text{Var2}, \text{Var3})$ (Signed DW)

Divides Var2 by Var3, and stores the result in Var1. The value in Var3 cannot be equal to 0(zero).

Example:

Divides the value in the internal memory \$2 by 5, and stores the result in the address \$3.

\$3 = \$2 / 5

Divides the value in the internal memory \$4 by 4.3, and stores the result in the address \$6.

\$6 = FDIV(\$4, 4.3) (Signed DW)

%, FMOD

Get Remainder

Equation: $\text{Var1} = \text{Var2} \% \text{Var3}[(\text{Signed} | \text{DW})]$

$\text{Var1} = \text{FMOD}(\text{Var2}, \text{Var3})$ (Signed DW)

This command divides Var2 by Var3, and stores the remainder in Var1. The value in Var3 cannot be equal to 0(zero).

Example:

Divides the value in the internal memory \$2 by 5, and stores the remainder in the address \$3.

\$3 = \$2 % 5

Divides the value in the internal memory \$4 by 4, and stores the remainder in the address \$6.

\$6 = FMOD(\$4, 4) (Signed DW)

=

Assignment

Equation: $\text{Var1} = \text{Var2}[(\text{Signed DW} | \text{DW})]$

This operator (=) assigns data at Var2 to Var1. After the PT executes MOV command, data at Var2 do not change.

Example:

Assigns a constant number 4 to the internal memory \$0.

\$0 = 4

Assigns the values in the internal memory address \$2 to the values in the internal memory address \$4.

\$4 = \$2

ADDSUMW

Repeated addition

Equation: $\text{Var1} = \text{ADDSUMW}(\text{Var2}, \text{Var3})[(\text{DW})]$

This command adds Var2, Var2+1, Var2+2, ..., and Var2+(the value of Var3 – 1), and stores the repeated addition result in Var1.

Example:

\$2 = 1

\$3 = 2

\$4 = 3

\$5 = 3

\$0 = ADDSUMW(\$2, \$5)

Adds the values in the internal memory address \$2 to \$4, and stores the sum total in the address \$0. You can specify the number of data you add with \$5. The value of the sum total is equal to 6(\$2 + \$3 + \$4).

■ Logical Operation

There are six logical operations, which include OR, AND, XOR, NOT, Shift-left and Shift-right. Each operation has three operands. Each operand can be the internal memory or constant. The operands that store output results must be the internal memory. The unit can be Word and Double Word. For details, refer to this table and examples below.

Command	Equation	Description	Remarks
	Var1 = Var2 Var3	Logical OR operation	These commands store the calculated result as WORD and DWORD.
&&	Var1 = Var2 && Var3	Logical AND operation	
^	Var1 = Var2 ^ Var3	Logical XOR operation	
NOT	Var1 = NOT Var2	Logical NOT operation	
<<	Var1 = Var2 << Var3	Logical Shift-left operation	
>>	Var1 = Var2 >> Var3	Logical Shift-right operation	

|

Logical OR operation

Equation: Var1 = Var2 | Var3[(DW)]

This command does the logical OR operation on Var2 and Var3, and stores the result in Var1.

Example:

\$2 = F000H

\$4 = 0F00H

\$2 = \$2 | \$4

Stores FF00H in \$2.

&&

Logical AND operation

Equation: Var1 = Var2 && Var3[(DW)]

This command does the logical AND operation on Var2 and Var3, and stores the result in Var1.

Example:

\$2 = F000H

\$4 = 0F00H

\$2 = \$2 && \$4

Stores 0000H in \$2.

^

Logical XOR operation

Equation: $\text{Var1} = \text{Var2} \wedge \text{Var3}[(\text{DW})]$

This command does the logical XOR operation on Var2 and Var3, and stores the result in Var1.

Example:

\$2 = F100H

\$4 = 0F00H

\$2 = \$2 ^ \$4

Stores FE00H in \$2.

NOT

Logical NOT operation

Equation: $\text{Var1} = \text{NOT } \text{Var2} [(\text{Signed} | \text{DW})]$

This command does the logical NOT operation on Var2, and stores the result in Var1.

Example:

\$2 = F100H

\$4 = NOT \$2

Stores 0EFFH in \$4.

<<

Logical Shift-left operation

Equation: $\text{Var1} = \text{Var2} \ll \text{Var3}[(\text{DW})]$

This command shifts Var2 (WORD/DWORD) data to the left (the number of bit is Var3), and stores the result in Var1.

Example:

\$2 = F100H

\$2 = \$2 << 4

Shifts \$2 to the left by 4 bits. Var1 becomes 1000H.

>>

Logical Shift-right operation

Equation: $\text{Var1} = \text{Var2} \gg \text{Var3}[(\text{DW})]$

This command shifts Var2 (WORD/DWORD) data to the right (the number of bit is Var3), and stores the result in Var1.

Example:

\$2 = F100H

\$2 = \$2 >> 4

Shifts \$2 to the right by 4 bits, and becomes 0F10H

■ Data Transfer

There are four Data transfer commands, which include MEMCOPY, MEMSET, STRCPYB and FMOV. For details, refer to this table and examples below.

Command	Equation	Description	Remarks
MEMCOPY	MEMCOPY (Var1, Var2, Var3)	Block move	Data type for Var1 and Var2 is address.
MEMSET	MEMSET (Var1, Var2, Var3)	Fills the memory	
STRCPYB	STRCPYB (Var1, Var2, Var3)	Converts text to ASCII code	Var2 is an input string.
FMOV	Var1 = FMOV(Var2)	Transfers float data	

MEMCOPY

Copies data of the specified number of words

Equation: MEMCOPY (Var1, Var2, Var3)

This command copies data from address Var2 to address Var1 in words. You can specify the number of words you copy with Var3. If the address at the copy destination becomes more than the maximum number, an error will occur when you execute validation.

Example:

Copies the data in \$0, \$1, \$2 and \$3 to \$10, \$11, \$12 and \$13 in sequence.

\$0 = 1

\$1 = 2

\$2 = 3

\$3 = 4

MEMCOPY (\$10, \$0, 4)

After the PT executes MEMCOPY command, \$10=1, \$11=2, \$12=3, \$13=4.

MEMSET

Fills the memory with the specified data

Equation: MEMSET (Var1, Var2, Var3) [(Signed)]

This command fills the memories from the address in Var1 with data in address Var2. The number of memories is Var3. If the write destination address becomes more than the maximum number, an error occurs when you execute validation.

Example:

\$5 = 10

MEMSET (\$0, \$5, 4)

Executes MEMSET command to fill \$0, \$1, \$2, \$3 with a constant 10.

STRCPYB

Converts Text to ASCII code

Equation: STRCPYB (Var1, "Var2")

This command converts text in address Var2 to ASCII code, and stores it in Var1. The maximum length is 128 words.

Example:

STRCPYB (\$1, "AB12")

After the PT executes STRCPYB command, it stores 4241H in \$1 and 3231H in \$2.

FMOV

Transfers Float Data

Equation: $Var1 = FMOV(Var2)$ (Signed DW)

This command transfers float data from Var2 to Var1. After the PT executes this command, there is no change in data of Var2.

Example:

Transfers a constant 44.3 to the internal memory address \$0.

$\$0 = FMOV(44.3)$ (Signed DW)

■ Data Conversion

Command	Equation	Description
BCD	$Var1 = BCD(Var2)$	Converts binary data to BCD
BIN	$Var1 = BIN(Var2)$	Converts from BCD data to binary.
XWD	$Var1 = XWD(Var2)$	Converts WORD to DWORD
XBW	$Var1 = XBW(Var2, Var3)$	Converts BYTE to WORD
XWB	$Var1 = XWB(Var2, Var3)$	Converts WORD to BYTE
SWAP	$SWAP(Var1, Var2, Var3)$	Swaps BYTE data
XCHG	$XCHG(Var1, Var2, Var3)$	Exchanges data
MAX	$Var1 = MAX(Var2, Var3)$	Gets maximum value
MIN	$Var1 = MIN(Var2, Var3)$	Gets minimum value
STR2H	$Var1 = STR2H(Var2, Var3, Var4)$	Converts text data (ASCII format) to hexadecimal data
H2STR	$Var1 = H2STR(Var2, Var3)$	Converts hexadecimal data to text data (ASCII format)
FCNV	$Var1 = FCNV(Var2)$	Converts integer to float value
ICNV	$Var1 = ICNV(Var2)$	Converts float value to integer

BCD

Converts binary data to BCD value

Equation: $Var1 = BCD(Var2)$ [(DW)]

This command converts the binary data in Var2 to BCD value, and stores it in Var1.

Example:

The binary data in \$4 is 5564.

After the PT executes BCD command, it converts the binary data in \$4 to 5564H.

$\$4 = 5564$

$\$4 = BCD(\$4)$

BIN

Converts BCD data to binary data value

Equation: $Var1 = BIN(Var2)$ [(DW)]

This command converts the BCD data in Var2 to binary data value, and stores in Var1.

Example:

The BCD (hexadecimal) data in \$4 is 5564H.

After the PT executes BIN command, it converts the BCD data in \$4 to 5564.

\$4 = 5564H

\$4 = BIN(\$4)

XWD

Converts WORD to DWORD

Equation: $\text{Var1} = \text{XWD}(\text{Var2})$ [Signed]

This command converts the WORD value in Var2 to DWORD value, and stores in Var1.

Example:

The WORD value in decimal format in \$4 is -7. After the PT executes XWD command, it converts the word value in \$4 to DWORD value and stores it in \$7.

\$4 = -7 Signed

\$7 = XWD(\$4)(Signed)

XBW

Converts BYTE to WORD

Equation: $\text{Var1} = \text{XBW}(\text{Var2}, \text{Var3})$

This command converts BYTE data (the number of bytes is Var3) from Var2 to WORD value, and stores the result in Var1. It converts two bytes of Var2 to two words and stores it in Var1. It fills the high byte with 0.

Example:

Assume that the value of \$65534 is 12. Converts 12 BYTES (6 WORDS) to 12 WORDS from \$785, and stores the result in \$10 to \$21.

\$10=XBW(\$785, \$65534)

XWB

Converts WORD to BYTE

Equation: $\text{Var1} = \text{XWB}(\text{Var2}, \text{Var3})$

This command converts WORD data (the number of bytes is Var3) from low-byte of Var2 to BYTE format, and stores the result in Var1. This command discards the high-byte of Var2.

Example:

Assume that the value of \$985 is 12. This command reads 12 WORDS from low-byte of \$986, and converts these 12 WORDS to 12 BYTES (6 WORDS), and stores the result in \$65 to \$70.

\$65= XWB(\$986, \$985)

SWAP

Swaps BYTE Data

Equation: $\text{SWAP}(\text{Var1}, \text{Var2}, \text{Var3})$

This command swaps the high-byte and low-byte of Var2, Var2+1, Var2+2...Var2+Var3 (WORD), and stores the result in Var1, Var1+1, Var1+2...Var1+Var3 in sequence.

Example:

Swaps the high-byte and low-byte of \$10, \$11, ..., \$14, and stores the result in \$1, \$2, ..., \$5 in sequence.

SWAP(\$1, \$10, 5)

If \$11 = 1234H, after the PT executes SWAP command, \$2 = 3412H.

XCHG

Exchanges Data

Equation: XCHG (Var1, Var2, Var3)[(DW)]

This command exchanges the data of Var2, Var2+1, Var2+2...Var2+Var3 for the data of Var1, Var1+1, Var1+2..., Var1+Var3. After the PT executes XCHG command, it exchanges the data of Var1 for Var2.

Example:

Exchanges the data of \$10, \$11, ..., \$14 for the data of \$1, \$2, ..., \$5 in sequence.

XCHG(\$1, \$10, 5)

If \$11 = 1234H and \$2 = 5678H, after the PT executes XCHG command, \$2 = 1234H and \$1 = 5678H.

MAX

Gets Maximum Value

Equation: Var1 = MAX(Var2, Var3)[(Signed DW | DW)]

This command gets the maximum value from Var2 and Var3, and stores the result in Var1.

Example:

\$0 = 0

\$1 = 2

\$2 = 10

\$0 = MAX(\$1, \$2)

The result a \$0 = 10

MIN

Gets Minimum Value

Equation: Var1 = MIN(Var2, Var3)[(Signed DW | DW)]

This command gets the minimum value from Var2 and Var3, and stores the result in Var1.

Example:

\$0 = 0

\$1 = 2

\$2 = 10

\$0 = MIN(\$1, \$2)

The result a \$0 = 2

STR2H

Converts text data (ASCII format) to hexadecimal data.

Equation: $\text{Var1} = \text{STR2H}(\text{Var2}, \text{Var3}, \text{Var4})$

Var1: Data storage address of conversion destination. (Internal memory address)

Var2: Data storage address of conversion source. (Internal memory address)

Var3: Data size you convert

Var4: Data length

Var4==0: Data length is byte

Var4==1: Data length is word

Var4==2: Data length is double word

This command converts the text data in the address specified with Var2 by the size specified with Var3. Then it stores the result in Var1.

Example:

Converts the text data of \$100 to \$107 to hexadecimal data, and stores the result in \$0 to \$3.

Assume that the text data below are stored in \$100 to \$107 before the PT executes this command.

\$100	\$101	\$102	\$103	\$104	\$105	\$106	\$107
'1'	'2'	'3'	'4'	'5'	'6'	'7'	'8'

$\$0 = \text{STR2H}(\$100, 8, 0)$

The result $\rightarrow \$0 = 12\text{H}(\text{WORD})$

$\$1 = 34\text{H}(\text{WORD})$

$\$2 = 56\text{H}(\text{WORD})$

$\$3 = 78\text{H}(\text{WORD})$

H2STR

Converts hexadecimal data to text data (ASCII format)

Equation: $\text{Var1} = \text{H2STR}(\text{Var2}, \text{Var3})$

This command converts the hexadecimal data in the address specified with Var2 by the size specified with Var3. Then it stores the result in Var1.

Example:

$\$100 = 1234\text{H}$

$\$0 = \text{H2STR}(\$100, 1)$

The result $\rightarrow \$0 = 31\text{H}$

$\$1 = 32\text{H}$

$\$2 = 33\text{H}$

$\$2 = 34\text{H}$

FCNV

Converts integer to float value

Equation: $\text{Var1} = \text{FCNV}(\text{Var2})(\text{Signed DW})$

This command converts the integer in Var2 to float value, and stores it in Var1.

Example:

$\$2 = 100$

$\$1 = \text{FCNV}(\$2)(\text{Signed DW})$

The result $\rightarrow \$1 = 100.0$

ICNV

Converts float value to integer

Equation: Var1= ICNV (Var2)

This command converts the float value in Var2 to an integer, and stores in Var1.

Example:

\$2=FMOV(100.5) (Signed DW)

\$1 = ICNV (\$2)(Signed DW)

The result → \$1 = 100

■ **Comparison**

IF...THEN GOTO LABEL ...

Equation: IF expression THEN GOTO LABEL identifier

If the command of expression is true, the process goes to LABEL identifier to execute the program.

Comparison command table

Command	Description	Remarks
A == B	A is equal to B	A and B must be the internal memory or constant.
A != B	A is not equal to B	
A > B	A is greater than B	
A >= B	A is greater than or equal to B	
A < B	A is smaller than B	
A <= B	A is smaller than or equal to B	
A && B == 0	Executes AND command on A and B. The result is equal to 0	
A && B != 0	Executes AND command on A and B. The result is not equal to 0	
A == ON	A is ON	A is internal memory.
A == OFF	A is OFF	
IFB A == ON THEN	A is ON	A is internal memory or a PLC address.
IFB A == OFF THEN	A is OFF	
IF A == B THEN CALL C	Calls sub-macro if A is equal to B.	A is internal memory or a constant.

Example:

If \$2 is greater than or equal to 10, the process goes to LABEL 1 and continues to execute the program.

IF \$2 >= 10 THEN GOTO LABEL 1

.....

LABEL 1

.....

Equation: IFB Var1 == {ON | OFF} THEN GOTO LABEL identifier

If Var1 is ON or OFF, the process goes to LABEL identifier to continue to execute the program. Var1 is PLC address.

Example:

```
IFB $0.0 == ON THEN GOTO LABEL 1
```

IF...THEN CALL ...

Equation: IF Var1 == Var2 THEN CALL sub-macro number.

If Var1 is equal to Var2, this command calls sub-macro. Var1 and Var2 must be the internal memory or constant.

Example:

If \$2 is equal to 10, then this command calls sub-macro 1.

```
IF $2 == 10 THEN CALL 1
```

IF...ELSE...ENDIF

Equation:

```
IF expression1
    Statement1
ELSEIF expression2
    Statement2
ELSE
    Statement3
ENDIF
```

This command makes a logical decision in more than one condition. If the expression1 is true, this command executes the Statement1. If the expression1 is false, it checks if the expression2 is true or not. If the expression2 is true, it executes the Statement2. If both expression1 and expression2 are false, it executes the Statement3. For details on the expression, refer to the Comparison command table.

Example:

If \$1 is smaller than 100, executes \$1 = \$1 + 1. If \$1 is 100 or above, executes \$1 = \$1 + 10.

```
IF $1 < 100
    $1 = $1 + 1
ELSE
    $1 = $1 + 10
ENDIF
```

FCMP

Compares the data and stores the result

Equation: Var1 = FCMP(Var2, Var3)[(Signed DW)]

This command compares the size of Var2 and Var3. Then it stores the result in Var1.

	Var2 == Var3	Var2 > Var3	Var2 < Var3
Result to be stored	0	1	2

■ Flow Control

There are five types for flow control, which include GOTO, LABEL, CALL..RET, FOR...NEXT and END.

GOTO

Goes to a specific Label without condition

Equation: GOTO LABEL Var1

When the PT executed the GOTO statement, the process goes to the Label specified with Var1 and continues to execute the program.

Example:

Goes to the position of specified Label 2 without condition, and continues to execute the program.

GOTO LABEL 2

.....

LABEL 2

LABEL

GOTO statement shifts the program execution to the position of LABEL without condition

Equation: LABEL Var1

Note: You cannot use the same label more than one time in a Macro.

Example:

Goes to the position of specified Label 2, and continues to execute the program.

GOTO LABEL 2

.....

LABEL 2

.....

If you use more than one Label 2, an error will occur to tell you it is invalid.

LABEL 2

.....

CALL..RET

Calls sub-macro program

Equation: CALL Var1

Var1 is the sub-macro number. The sub-macro number can be 001 to 512. Var1 must be internal memory address or constant.

When the CALL command is executed, the process shifts to the sub-macro. If the RET command is executed in the sub-macro program, the process returns to the CALL source of the sub-macro. If there is not a RET command, after all commands in the called sub-macro are executed, the RET command is automatically executed. In the sub-macro program, you can also call other sub-macro. But to keep sufficient memory, the levels for CALL sub-macro must be less than 6 levels.

FOR...NEXT

Program Loop

Equation:

FOR Var1
Statement
NEXT

You can use this command for nested loops. FOR is the start of the loop and NEXT is the end of the loop. A maximum of five nested loops is possible. Var1 can be the internal memory or constant. When the PT executes this command, this command executes the number of times specified with Var1 Statement continuously. In the Statement, you can write a macro command that the PT executes again and again. You can change Var1 value in the Statement, but cannot change the number of times.

Example:

```
$10 = 10
$1 = 0
FOR $10
$1 = $1 + 1
$10 = 2
NEXT
```

After the operation, the result is \$1 = 10, \$10 = 2.

Note: You cannot change the loop times even when you reset the value in \$10.

END

Ends the macro

Equation:

Statements1

END

Statements2

This command ends the macro program. It executes the Statements1 and then ends the macro executing. It does not execute the Statements2. If there is END command in sub-macro, the program ends here.

Example:

```
$1 = 10
$1 = $1 + 1
END
$1 = $1 + 1
```

After the operation, the result is \$1 = 11, not \$1 = 12 as the END command ended the macro program.

■ Bit Setting

There are four BIT settings, which include BITSET, BITCLR, BITINV and BITGET.

Bit setting command table

Command	Equation	Description
BITSET	BITSET Var1	Sets Var1 bit to be ON.
BITCLR	BITCLR Var1	Sets Var1 bit to be OFF.

Command	Equation	Description
BITINV	BITINV Var1	Sets Var1 bit to be reversed.
BITGET	Var1 = BITGET Var2	Gets Var2 bit value and stores in Var1.

BITSET

Sets specified bit to be ON

Equation: BITSET Var1

This command sets Var1 bit to be ON

Example:

Sets 1 in the bit 0 in the internal memory \$0.

\$0 = FFFE_H

BITSET \$0.0

The result → \$0 = FFFF_H

BITCLR

Sets specified bit to be OFF

Equation: BITCLR Var1

This command sets Var1 bit to be OFF

Example:

Sets 0 in the bit 0 in the internal memory \$0.

\$0 = FFFF_H

BITCLR \$0.0

The result → \$0 = FFFE_H

BITINV

Sets specified bit to be reversed. ON a OFF, OFF a ON

Equation: BITINV Var1

This command sets Var1 bit to be reversed. ON a OFF, OFF a ON

Example:

Inverses the bit 0 in the internal memory \$0, and stores it.

\$0 = FFFE_H

BITINV \$0.0

The result → \$0 = FFFF_H

BITGET

Gets bit value

Equation: Var1 = BITGET Var2

This command gets Var2 bit value, and stores in Var1

Example:

Gets the 3rd bit value in \$0, and stores it to the 5th bit in \$10.

\$0 = FFFE_H

\$10 = 0

\$10.5 = BITGET \$0.3

The result → \$10 = 20_H

■ Communication

Communication command table

Command	Equation	Description
INITCOM	Var1= INITCOM (Var2)	Initial setup COM port
ADDSUM	Var1=ADDSUM(Var2, Var3)	Uses addition to calculate checksum
XORSUM	Var1 = XORSUM(Var2, Var3)	Uses XOR to calculate checksum
PUTCHARS (See note.)	Var1 = PUTCHARS(Var2, Var3, Var4)	Outputs characters by COM port
GETCHARS (See note.)	Var1 = GETCHARS(Var2, Var3, Var4)	Gets characters by COM port
SELECTCOM	SELECTCOM(Var1)	Selects COM port
CLEARCOM-BUFFER (See note.)	CLEARCOMBUFFER(Var1, Var2)	Clears COM port buffer
CHRCHKSUM	Var1 = CHRCHKSUM(Var2, Var3, Var4)	Calculates the ASCII data of string, character length and checksum.

Note There are macros that are not synchronized with any screen events, such as switching screens or pressing a switch: Project Resident Macro, Project Periodic Macro, and Screen Periodic Macro. If communications commands that access communications buffers (PUTCHARS(), GETCHARS(), or CLEARCOMBUFFER()) are placed in any of these macros, the communications buffers may be read or written at unexpected timing. This may conflict with commands in other macros, causing incorrect data to be read or causing data to be corrupted by being overwritten. When combining macros that are not synchronized with any screen events or when combining a macro that is not synchronized with a screen event with another type of macro, place any commands that access the communications buffers into one macro.

INITCOM

After you set each COM port, this command starts communication. It stores the result in Var1.

- 1: Completed normally
- 0: Failed

INITCOM

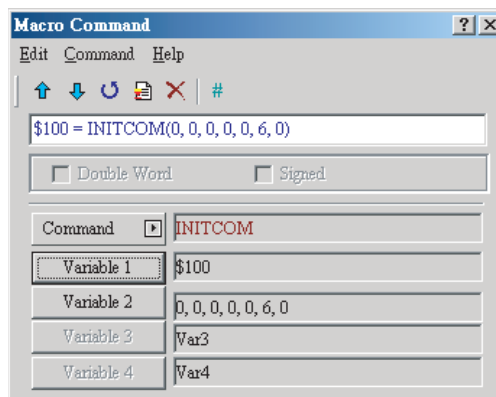

Var2 settings in INITCOM

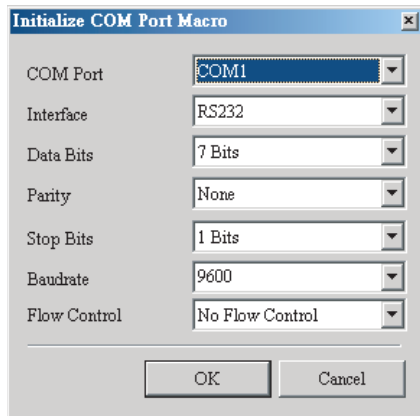

COM port



Interface



Data Bit



Parity bit



Stop bit



Baud rate

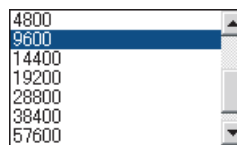

Flow control

To make sure that data transmit between computer and PT is completed, you can use Flow Control functions.

Flow control	
No Flow Control	This function disables the flow control function.
CTS/RTS	This function is a flow control for hardware. It uses handshaking signal to control receiving and sending data.
DSR/DTR	This function is also a flow control for hardware. You can use this function to connect a computer and a PT directly by a cable.
XON/XOFF	This function is a flow control for software. It creates a control code with software and adds the code to the transmission data.

ADDSUM

Adds to calculate checksum

Var1=ADDSUM(Var2, Var3)

Var1: Value after calculation

Var2: Starting address for calculation

Var3: Data length

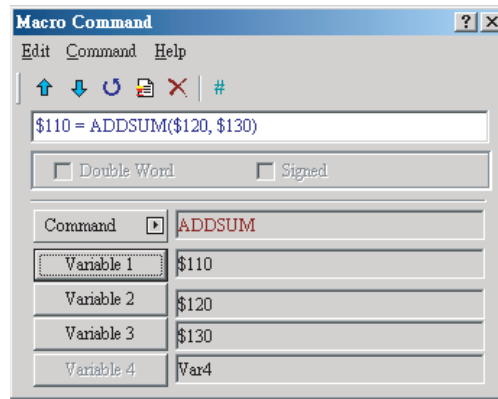

XORSUM

This command uses XOR to calculate checksum.

Var1=XORSUM (Var2, Var3)

Var1: Value after calculation

Var2: Starting address for calculation

Var3: Data length

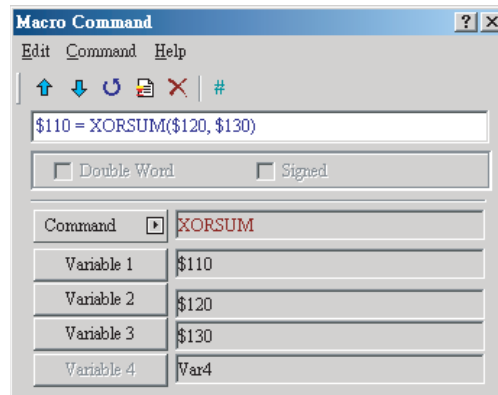

PUTCHARS

Outputs characters by COM port

Var1= PUTCHARS (Var2, Var3, Var4). The result will be stored in Var1.

Var1: Response value after communication

1: Completed normally

0: Failed

Var2: Starting address of transmission data

Var3: Data length

Var4: Allowance communication time (unit is ms)

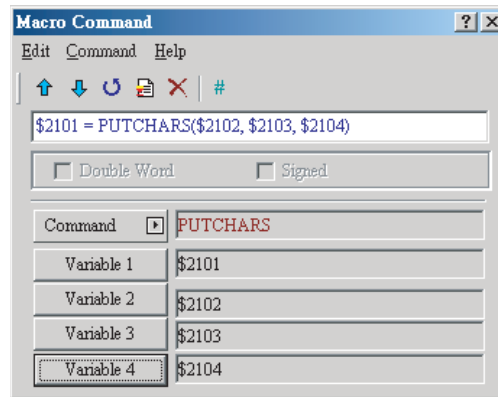

GETCHARS

Gets characters by COM port

Var1= GETCHARS (Var2, Var3, Var4). The result will be stored in Var1.

Var1: Response value after communication

1: Completed normally

0: Failed

Var2: Starting address of transmission data

Var3: Data length

Var4: Allowance communication time (unit is ms).

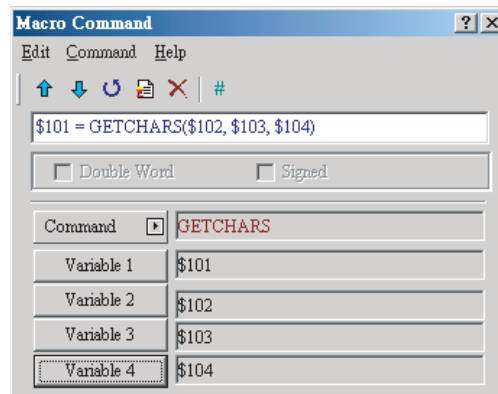

SELECTCOM

Selects COM port

If you do not connect the PLC (if you set the **Protocol** to **NULL** in **PT Menu – PT Setting**), you can use two COM ports (0:COM1, 1:COM2) at the same time.

Note After the PT executes this command, the PT executes all communication commands through the specified COM port. Other macros do not affect each other, even if the PT uses a different macro.

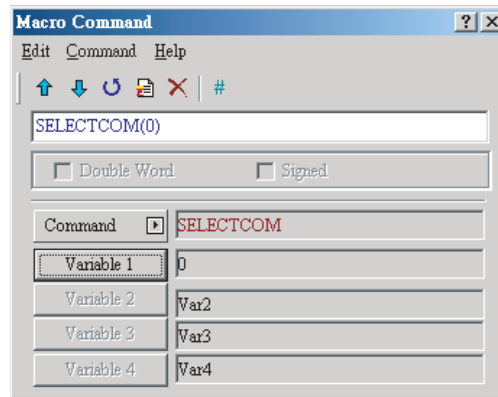

CLEARCOMBUFFER

Clears the COM port buffer

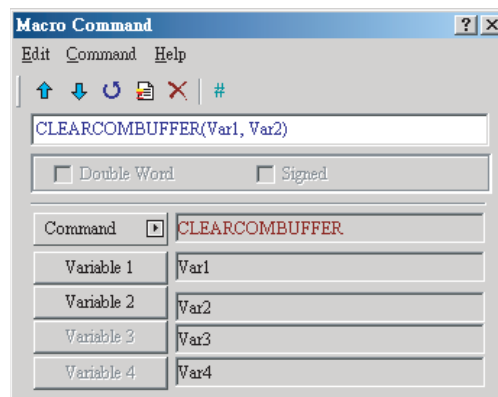

Equation: CLEARCOMBUFFER(Var1, Var2)

Var1: The number of communication ports. Constant 0(COM1) or 1(COM2).

Var2: The type of buffer area. Constant 0 (receiving buffer area) or 1 (sending buffer area)

Example:

Clears the sending buffer area of COM2

CLEARCOMBUFFER(1, 1)

CHRCHKSUM

Calculates the ASCII data of the string, character length and checksum.

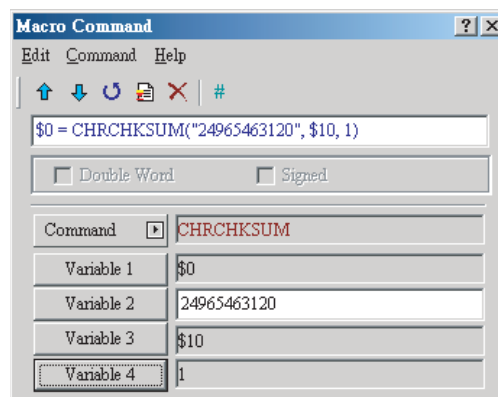

Equation: Var1 = CHRCHKSUM(Var2, Var3, Var4)

Var1: The internal memory address where the character length of ASCII data of Var2 + data length of checksum is stored.

Var2: The string of text.

Var3: The internal memory address where the ASCII data of Var2 and checksum is stored.

Var4: The data length of the checksum that stores in Var3. 1 represents byte and 2 represents word.

Operation of checksum:

Converts format of each data characters to ASCII code and adds them up. For example, when '1' is converted to ASCII code '31H' and '4' is converted to ASCII code '34H', the checksum is 31H + 34H = 65H.

Example:

Calculates the ASCII data of 14, data length and checksum.

\$0 = CHRCHKSUM("14", \$10, 2)

After the above operation, it stores 4 in \$0. 4 represents that 2 bytes (ASCII data length) + 2 bytes (data length of checksum) = 4 bytes. The checksum that is stored in \$10 is 65H.

■ Others

Command	Equation	Description
TIMETICK	Var1 = TIMETICK	Gets the time from system startup to present
GETLASSERROR	Var1 = GETLASTERROR	Gets last error value
#	#Var1	Comment
DELAY	DELAY Var1	System delay
GETSYSTEMTIME	Var1 = GETSYSTEMTIME	Gets system time
SETSYSTEMTIME	SETSYSTEMTIME(Var1)	Sets system time
GETHISTORY	Var1 = GETHISTORY (Var2, Var3, Var4, Var5, Var6)	Gets history data

TIMETICK

Gets the time from system startup to present, and saves into the specified address.

The time unit is 100ms.

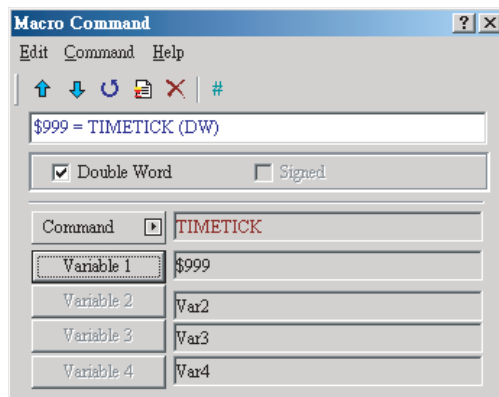

GETLASTERROR

Gets the last error value

If there is no error, the result of GETLASTERROR is 0. Even if each Macro is executed at the same time, the error message does not affect the macro. For details on error code, refer to 6-5-4 Error Messages.

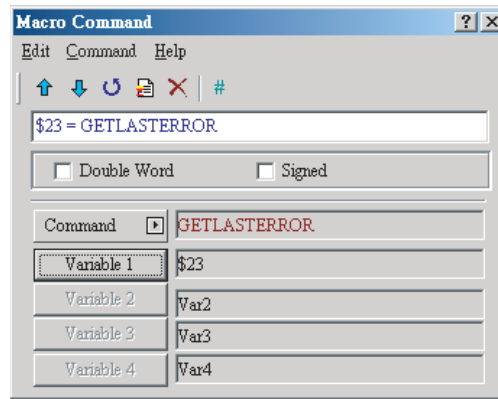

COMMENT

Inserts macro descriptions

Macro descriptions make the operations clear. This command does not have an effect on the Macro function. To change the equation to be a comment, put “#” symbol in front of the equation. The comment starts from “#” symbol and ends at the end of the sentence. To change the comment to be equation, remove the “#” symbol.

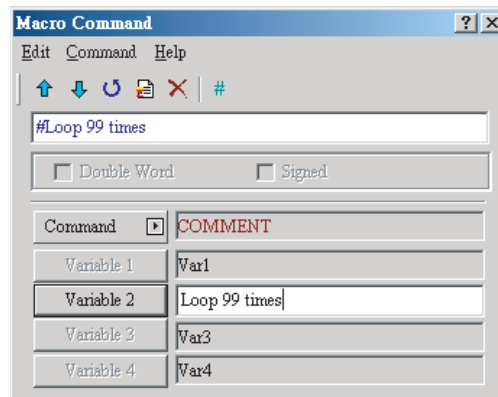

DELAY

Delays the user setting time by system

Delay can occur because of the structure of the NP-series PTs. The unit of delay time is ms.

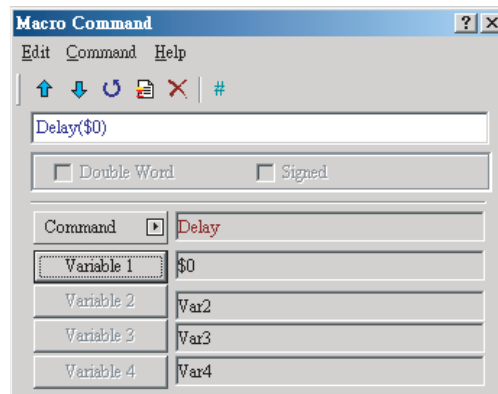

GETSYSTEMTIME

Gets system time

Equation: Var1 = GETSYSTEMTIME

Var1 is the starting address of continuous 7 Words in the internal memory address.

Var1 Year

Var1 + 1 Month

Var1 + 2 Date

Var1 + 3 Week

Var1 + 4 Hour

Var1 + 5 Minute

Var1 + 6 Second

Example:

Now the system time is 2008/01/09 Wed 09:26:25. This command gets the current system time, and stores it in \$1 to \$7.

\$1 = GETSYSTEMTIME

Gets \$1 = 2008, \$2 = 01, \$3 = 9, \$4 = 3, \$5 = 9, \$6 = 26, \$7 = 25

SETSYSTEMTIME

Sets system time

Equation: SETSYSTEMTIME(Var1)

Var1 is the starting address of continuous 7 words in the internal memory address.

Var1 Year

Var1 + 1 Month

Var1 + 2 Date

Var1 + 3 Week

Var1 + 4 Hour

Var1 + 5 Minute

Var1 + 6 Second

Example:

Sets the current system time as 2008/01/09 Wed 09:26:25.

\$1 = 2008

\$2 = 1

\$3 = 9

\$4 = 3

\$5 = 9

\$6 = 26

\$7 = 25

SETSYSTEMTIME(\$1)

GETHISTORY

Gets history data

Equation: Var1 = GETHISTORY (Var2, Var3, Var4, Var5, Var6)

Var1: Specify the internal memory address where the data length is stored.

Var2: Use the internal memory or constant to specify the logging buffer number.

- Var3: Use the internal memory address or constant to decide which number of logged data is stored. Specify the number 1, 2, 3,..., (logging points).
- Var4: Use the internal memory or constant to specify points for reading.
- Var5: Use the internal memory or host address to specify a starting address for saving data.
- Var6: Use the internal memory or constant to specify a data type to read.
- 0: Data, 1: Time, 2: Time and Data

6-5-4 Error Messages

The Output Window shows errors after validation.

■ Error Messages While You Edit

Code – 100: LABEL cannot be found

There is no LABEL that GOTO specifies.

Code – 101: Recursion occurs

This error message usually shows in sub-macro. The function of a sub-macro to call is called recursion whether the PT calls it directly or not. The sub-macro does not usually use recursion. As an alternative for it, you can use GOTO or FOR (infinite times).

Code – 102: More than 3 nested FOR is used

This error message tells you not to use more than 3 nested FOR commands to keep sufficient memory. As an alternative for it, you can use GOTO or IF.

Code – 103: Sub-macro does not exist

This error message tells you that there is no sub-macro in the program. For example, CALL 5 means CALL sub-macro 5. This error message shows when you do not edit sub-macro 5 in the program. This message shows to make sure that there are no errors. These errors include input error and absence of related sub-macro.

Code – 104: Number of NEXT is less than the number of FOR

The number of NEXT and FOR commands must be the same. This error code shows when the number of NEXT commands is less than that of FOR commands.

Code – 105: Number of FOR is less than the number of NEXT

The number of FOR and NEXT commands must be the same. This error code shows when the number of FOR commands is less than that of NEXT commands.

Code – 106: Repeated LABEL

This error message shows to tell you that one macro has the same LABEL more than one time. It shows during validation. If you use the same LABEL more than one time, the program does not operate correctly.

Code – 107: There is RET in Macro

This error message tells you that there is RET command in macro. To return program, you can use RET command in sub-macro. But in macro, you must use END.

■ PT Macro Error Messages

The user can read error messages by macro.

Code – 10: GOTO Error

This message tells you that there is GOTO error in macro.

Code – 11: Stack Overflow

This message tells you that stack in macro is full. This can occur if you use too many sub-macros or execute different macros at the same time. This message shows to keep sufficient memory.

Code – 12: CALL Empty Sub-macro

This message tells you that there is a CALL sub-macro error. The sub-macro that is called must not be an empty sub-macro. This message shows to prevent an unexpected error.

Code – 13: Data Read Error

This message tells you that there is a data read error. This can occur if there is a memory data error, but usually it occurs if there is a host data read error.

Code – 14: Data Write Error

This message tells you that there is a data write error. This can occur if there is a memory data error, but usually it occurs if there is a host data write error.

Code – 15: Divisor is 0

This error message tells you that the divisor is 0 when you do division operation.

■ PT Communication Error Messages**Communication Busy**

Error Message: Com x Station x: Communication Busy ...

Unknown Code

Error Message: Com x Station x: Receive Unknown Code ...

No Response from Controller

Error Message: Com x Station x: Controller No Response ...

PT CheckSum Error

Error Message: Com x Station x: Check Sum Error in PT Message ...

Controller CheckSum Error

Error Message: Com x Station x: Check Sum Error in Controller Message ...

Incorrect Command

Error Message: Com x Station x: Command Can Not be Executed ...

Incorrect Address

Error Message: Com x Station x: Address Fault ...

Incorrect Value

Error Message: Com x Station x: Value is Incorrect ...

Controller is Busy

Error Message: Com x Station x: Controller is Busy ...

CTS Signal Fail

Error Message: Com x Station x: CTS Signal Fail ...

No Such Resource in Controller

Error Message: Com x Station x: No Such Resource ...

No Such Service in Controller

Error Message: Com x Station x: No Such Service ...

Must Retry

Error Message: Com x Station x: Must Retry ...

PT Station Number Error

Error Message: Com x Station x: PT Station Number Error ...

Controller Station Number Error

Error Message: Com x Station x: Controller Station Number Error ...

UART Communication Error

Error Message: Com x Station x: UART Communication Error ...

Other Communication Error

Error Message: Comx Station x: Other Communication Error ...

6-6 Control Block and Status Block

6-6-1 Control Block

When you set the host address and size in Control Block, the host can control an NP-series PT. The control area consists of continuous word addresses. The length is between 0 and 8 words. The length can change if the function that you use on screen data changes. For example, for the Data Log function, a minimum of 5 words is necessary. When the size of Control Block is 0, the Control Block function is disabled. When the Control Block function is enabled, the host can control the PT. For details on settings, refer to *6-6-3 Settings*.

This table shows functions and gives explanations of each word.

Word	Address	Offset
0	Address for Designating Screen Number (SNIR)	+0
1	Control Flag Address (CFR)	+1
2	Curve Control Address (CUCR)	+2
3	Address for Sampling Data Log Buffer (HBSR)	+3
4	Address for Clearing Data Log Buffer (HBCR)	+4
5	Data Block Control Address (RECR)	+5
6	Address for Designating Data Block Group Number (RBIR)	+6
7	System Control Flag Address (SCFR)	+7

■ Address for Designating Screen Number (SNIR)

Word	Function
0	Designate Screen Number

When you write a screen number to SNIR, the NP screen changes to that number. This function allows the NP display screen to be changed from the host. Specify the numerical value storage format in signed decimal, unsigned decimal, hexadecimal, or binary.

When opening or closing a pop-up screen, write 0 to SNIR.

■ Control Flag Address (CFR)

Word	Function
0	Enable/Disable Communication
1	Turn ON/Turn OFF Backlight
2	Sound the Siren
3	Clear Alarm Buffer
4	Clear Alarm Counter
5 to 7	Reserved
8	Set User Security Level (bit 0)
9	Set User Security Level (bit 1)
10	Set User Security Level (bit 2)
11 to 15	Reserved

Enable/Disable Communication

Bit 0 controls the PT communications. When bit 0 is turned ON, the PT communication is disabled. When bit 0 turns OFF, the PT communication is enabled.

Turn ON/Turn OFF Backlight

Bit 1 controls the PT backlight. When bit 1 is turned ON, the PT backlight turns OFF. When bit 1 turns OFF, the PT backlight turns ON.

Sound the Siren

Bit 2 controls the PT siren. When bit 2 is turned ON, the siren starts. When bit 2 is turned OFF, the siren stops.

Clear Control Flag for Alarm Buffer

Bit 3 clears the alarm buffer. When bit 3 is turned ON, the alarm buffer is cleared. To control the alarm buffer again, this flag must be turned OFF and then ON.

Clear Control Flag for Alarm Counter

Bit 4 clears the alarm counter. When bit 4 is turned ON, the alarm counter is cleared. To control the alarm counter again, this flag must be turned OFF and then ON.

Set User Security Level

Bits 8 to 10 set the PT user security level. The level is from 0 to 7. MSB is Bit 10, and LSB is Bit 8. The default level is the **Starting Level** set with the **PT Setting** Dialog Box.

If the security level of an object is higher than the current security level, the user must enter a password. The security level will then change to the higher level. The user can thus use all objects with a security level that is lower than or equal to this new user security level.

If the user changes to the system menu and back to the application, the user security level goes back to the default level.

■ Curve Control Address (CUCR)

Bit	Function
0	Curve Sampling Flag 1
1	Curve Sampling Flag 2
2	Curve Sampling Flag 3
3	Curve Sampling Flag 4
4 to 7	Reserved
8	Curve Clear Flag 1
9	Curve Clear Flag 2
10	Curve Clear Flag 3
11	Curve Clear Flag 4
12 to 15	Reserved

Curve Sampling Control Flag (1-4)

Bits 0 to 3 control the curve (Broken-Line or XY Distribution) sampling.

When this control flag (Bit 0 to Bit 3) is turned ON, the PT reads continuous data from the set host address to sample once, changes the data to graph and shows it on PT screen. To control it again, this flag must be turned OFF and then ON.

Curve Clear Control Flag (1-4)

Bits 8 to 11 clear the curve (Broken-Line or XY Distribution) when this control flag (Bit 8 to Bit 11) is turned ON. To clear it again, this flag must be turned OFF and then ON.

■ Address for Sampling Data Log Buffer (HBSR)

The NP-series PT has 12 bits that control the sampling address of data log buffer. These bits not only sample on the *Sampling Cycle* specified in *Data Log Setting* Dialog Box of the NP-Designer, but also sample or clear the data log buffer through the host. For details on the settings of sampling data log buffer, refer to *Data Log Setting of 6-2-4 PT Menu*.

Bit	Function
0	Control Flag for Sampling Data Log Buffer 1
1	Control Flag for Sampling Data Log Buffer 2
2	Control Flag for Sampling Data Log Buffer 3
3	Control Flag for Sampling Data Log Buffer 4
4	Control Flag for Sampling Data Log Buffer 5
5	Control Flag for Sampling Data Log Buffer 6
6	Control Flag for Sampling Data Log Buffer 7
7	Control Flag for Sampling Data Log Buffer 8
8	Control Flag for Sampling Data Log Buffer 9
9	Control Flag for Sampling Data Log Buffer 10
10	Control Flag for Sampling Data Log Buffer 11
11	Control Flag for Sampling Data Log Buffer 12
12 to 15	Reserved

Control Flag Address for Sampling Data Log Buffer

Bits 0 to 11 control the sampling data log buffer operation of PT by the host. When this control flag (Bit 0 to Bit 11) is turned ON, the PT samples one time. To control the flag again, this flag must be turned OFF and then ON.

■ Address for Clearing Data Log Buffer (HBCR)

Bit	Function
0	Clear Flag of Data Log Buffer 1
1	Clear Flag of Data Log Buffer 2
2	Clear Flag of Data Log Buffer 3
3	Clear Flag of Data Log Buffer 4
4	Clear Flag of Data Log Buffer 5
5	Clear Flag of Data Log Buffer 6
6	Clear Flag of Data Log Buffer 7
7	Clear Flag of Data Log Buffer 8
8	Clear Flag of Data Log Buffer 9
9	Clear Flag of Data Log Buffer 10
10	Clear Flag of Data Log Buffer 11
11	Clear Flag of Data Log Buffer 12
12 to 15	Reserved

Clear Flag of Data Log Buffer

Bits 0 to 11 clear the PT data logs. When the control flag (Bit 0 to Bit 11) is turned ON, it clears the PT data logs. To control this flag again, this flag must be turned OFF and then ON.

■ Data Block Control Address (RECR)

Bit	Function
0	Control Flag for Changing Data Block Group Number
1	Control Flag for Reading Data Block (Host → PT)

Bit	Function
2	Control Flag for Writing Data Block (PT → Host)
3 to 15	Reserved

Control Flag for Changing Data Block Group Number

Bit 0 specifies the data block group number (RCPNo).

To specify it,

- 1,2,3...**
1. Write the data block group number (N) to Designated Data block Group Number Address (RBIR), and
 2. Turn ON this control flag (Bit 0).

After the above settings, the RCPNo changes to N automatically.

To control it again, this flag must be turned OFF and then ON.

Control Flag for Reading Data Block (Host → PT)

Bit 1 reads the data block from the host and stores the data block in the specified area of PT.

To read and store the data block,

- 1,2,3...**
1. Specify the data block group number (N).
 2. Turn ON this control flag (Bit 1).

To control it again, this flag must be turned OFF and then ON.

Control Flag for Writing Data Block (PT → Host)

Bit 2 writes the data block to the host.

To write it,

- 1,2,3...**
1. Specify the data block group number (N). (Refer to the Control flag for changing data block group number above)
 2. Turn ON the control flag (bit 2).

To control it again, this flag must be turned OFF and then ON.

■ **Address for Designating Data Block Group Number (RBIR)**

Word	Function
0	Designate Data Block Group Number

When the Control Flag for Changing Data Block Group Number is turned ON to write the data block group number (N) into Address for Designating Data Block Group Number (RBIR), the RCP No changes.

■ **System Control Flag Address (SCFR)**

Bit	Function
0	Multi-language Setting Value (bit 0)
1	Multi-language Setting Value (bit 1)
2	Multi-language Setting Value (bit 2)
3	Multi-language Setting Value (bit 3)
4	Multi-language Setting Value (bit 4)
5	Multi-language Setting Value (bit 5)
6	Multi-language Setting Value (bit 6)
7	Multi-language Setting Value (bit 7)
8 to 15	Reserved

■ Multi-language Setting Value

Bits 0 to 7 store the designated multi-language setting value. They also command the PT to switch to the specified language of a value that the user sets in this address. The setting range is between 0 and 255. MSB is bit 7, and LSB is bit 0.

Note: If the user set a value that is not in the multi-language setting, the multi-language state does not change. The state before the value is set remains.

6-6-2 Status Block

When you set the address in **Status Block**, the host can read the status of NP-Series PT. If the size of Control Block is 0, the **Control Block** function is disabled. When the **Control Block** function is disabled, the **Status Block** function is also disabled. When the Status Block function is enabled, the host reads the PT status. For details on settings, refer to 6-6-3 Settings.

This table shows functions and gives explanations of each word.

Word	Address	Offset
0	Status Address for General Control (GCSR)	+0
1	Status Address for Screen Number (SNSR)	+1
2	Status Address for Curve Control (CCSR)	+2
3	Status Address for Sampling Data Log Buffer (HSSR)	+3
4	Status Address for Clearing Data Log Buffer (HCSR)	+4
5	Data Block Status Address (RESR)	+5
6	Status Address for Data block Number (RBSR)	+6
7	Status Address 2 for General Control (GCSR2)	+7

■ Status Address for General Control (GCSR)

Bit	Function
0	Screen Switch Status
1 to 2	Reserved
3	Clear Status of Alarm Buffer
4	Clear Status of Alarm Counter
5 to 7	Reserved
8	User Security Level Status (bit 0)
9	User Security Level Status (bit 1)
10	User Security Level Status (bit 2)
11 to 15	Reserved

Screen Switch Status

When the PT switches the screen, bit 0 is turned ON. After the screen switch is completed, bit 0 is turned OFF.

Clear Status of Alarm Buffer

When the PT clears the alarm buffer, bit 3 is turned ON. After this function is completed, bit 3 is turned OFF.

Clear Status of Alarm Counter

When the PT clears the alarm counter, bit 4 is turned ON. After this function is completed, bit 4 is turned OFF.

User Security Level Status

Bits 8 to 10 hold the current user security level (0 to 7). MSB is bit 10, and LSB is bit 8.

User Security Level \ Bit	Bit 8	Bit 9	Bit 10
0	OFF	OFF	OFF
1	ON	OFF	OFF
2	OFF	ON	OFF
3	ON	ON	OFF
4	OFF	OFF	ON
5	ON	OFF	ON
6	OFF	ON	ON
7	ON	ON	ON

■ **Status Address for Screen Number (SNSR)**

Word	Function
0	The Last Open Screen Number

The last Open Screen Number

This address stores the last screen number you opened. When the user switches the screen, word 0 stores the last screen or pop-up screen that the users opened.

■ **Status Address of Curve Control (CCSR)**

Bit	Function
0	Sampling Status of Curve 1
1	Sampling Status of Curve 2
2	Sampling Status of Curve 3
3	Sampling Status of Curve 4
8	Clear Status of Curve 1
9	Clear Status of Curve 2
10	Clear Status of Curve 3
11	Clear Status of Curve 4
4 to 7, 12 to 15	Reserved

Curve Sampling Status Flag

When the PT samples a curve or XY distribution, the curve sampling status flag (bits 0 to 3) is turned ON. After the sampling operation is completed, the curve sampling status flag is turned OFF.

Curve Clear Status Flag

When the PT clears a curve or XY Distribution, the curve clear status flag (bits 8 to 11) is turned ON. After the clear operation is completed, the curve clear status flag is turned OFF.

■ **Status Address for Sampling Data Log Buffer (HSSR)**

Bit	Function
0	Sampling Status of Data Log Buffer 1
1	Sampling Status of Data Log Buffer 2
2	Sampling Status of Data Log Buffer 3
3	Sampling Status of Data Log Buffer 4
4	Sampling Status of Data Log Buffer 5
5	Sampling Status of Data Log Buffer 6
6	Sampling Status of Data Log Buffer 7
7	Sampling Status of Data Log Buffer 8
8	Sampling Status of Data Log Buffer 9
9	Sampling Status of Data Log Buffer 10
10	Sampling Status of Data Log Buffer 11
11	Sampling Status of Data Log Buffer 12
12 to 15	Reserved

Sampling Data Log Buffer Status Flag

When the PT samples the data log buffer, the sampling data log buffer status flag (bits 0 to 11) is turned ON. After the sampling operation is completed, the sampling data log buffer status flag is turned OFF.

■ **Status Address for Clearing Data Log Buffer (HCSR)**

Bit	Function
0	Clear Status of Data Log Buffer 1
1	Clear Status of Data Log Buffer 2
2	Clear Status of Data Log Buffer 3
3	Clear Status of Data Log Buffer 4
4	Clear Status of Data Log Buffer 5
5	Clear Status of Data Log Buffer 6
6	Clear Status of Data Log Buffer 7
7	Clear Status of Data Log Buffer 8
8	Clear Status of Data Log Buffer 9
9	Clear Status of Data Log Buffer 10
10	Clear Status of Data Log Buffer 11
11	Clear Status of Data Log Buffer 12
12 to 15	Reserved

Clear Data Log Buffer Flag

When the PT clears data log buffer, the clear data log buffer status flag (bits 0 to 11) is turned ON. After the clearing operation is completed, the clear data log buffer status flag is turned OFF.

■ **Data Block Status Address (RESR)**

Bit	Function
0	Change Status of Data Block Number
1	Data Block Read Status (Host → PT)
2	Data Block Write Status (PT → Host)
3 to 15	Reserved

Change Status of Data Block Number Flag

When the host changes the data block number, the change status of data block number flag (bit 0) is turned ON. After the PT changes the data block number and updates the RCPNo value, the change status of data block number flag is turned OFF.

Data Block Read Status Flag

When the PT reads one data block data from the host, the data block read status flag (bit 1) is turned ON. When the PT reads and saves the data block data fully, the data block read status flag is turned OFF.

Data Block Write Status Flag

When the PT sends one data block data to the host, the data block write status flag (bit 2) is turned ON. When the PT sends and writes the data block data to the host fully, the data block write status flag is turned OFF.

■ Status Address for Data Block Number (RBSR)

Word	Function
0	Current Data Block Number

When the host or PT changes the data block number address (RCPNo), the PT also updates the Status Address for Data Block Number (RBSR). To know the current data block number, this Status Address for Data Block Number (RBSR) must be monitored.

■ Status Address 2 for General Control (GCSR2)

Bit	Function
0	Multi-language Status Value (bit 0)
1	Multi-language Status Value (bit 1)
2	Multi-language Status Value (bit 2)
3	Multi-language Status Value (bit 3)
4	Multi-language Status Value (bit 4)
5	Multi-language Status Value (bit 5)
6	Multi-language Status Value (bit 6)
7	Multi-language Status Value (bit 7)
8 to 15	Reserved

Multi-language Status Value

Bits 0 to 7 read the current language that the PT shows from the multi-language status value.

Note: The PT stores the *Value* in the *Screen Data Multi-Language* Field. (*PT* Menu – *PT Setting* – *Multi-Language* Tab – *Screen Data Multi-Language* Field)

6-6-3 Settings

To control the PT and read the status, you must make these settings.

- 1,2,3...
1. Select **PT Setting** from **PT Menu**. The **PT Setting** Dialog Box shows.
 2. Select **Standard** Tab Page.
 3. Specify a starting address and size in the **Control Block** Field.
 4. Specify a starting address in the **Status Block** Field.

The screenshot shows the 'PT Setting' dialog box with the 'Standard' tab selected. The dialog is divided into several sections:

- Standard**: Project Name (HMI), Model (NP3-MQ000), Hold Data Place (SRAM), Startup Delay Time (0 s), Project Periodic Macro Delay Time (100 ms).
- Control Block**: Address (SERIALA:DM0), Size (1), Clear flag after done (unchecked).
- Status Block**: Address (SERIALA:DM10).
- Optimize Type**: Optimize Dynamic (selected), Optimize Static (unselected).
- System menu language**: English.
- Security**: Password (empty), Starting Level (0), Prompt for Level Insufficient (unchecked).

Buttons for 'OK' and 'Cancel' are located at the bottom right.

6-7 Internal Memory

■ Internal Address (R/W): \$

Word access: \$n (n: 0 to 65535)

Bit access: \$n.b (n: 0 to 65535, b: 0 to 15)

The NP-series PT has 65536 16-bit internal addresses (\$0 to \$65535).

■ Non-volatile Internal Address (R/W): \$M

Word access: \$Mn (n: 0 to 1023)

Bit access: \$Mn.b (n: 0 to 1023, b: 0 to 15)

The NP-series PT has 1024 16-bit non-volatile internal addresses (\$M0 to \$M1023).

■ Indirect Address (R/W): *\$

Word access: *\$n (n: 0 to 65535)

The indirect address is an area where an address is stored. The user must get the address from \$n, and then get the value stored in this address.

*\$n =

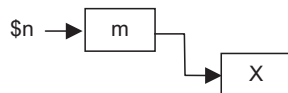

For example, if \$n = m; \$m = X; then *\$n = X. The value of m must not be more than 65535.

■ Data Block Number Address (R/W): RCPNO

You can specify the data block group. The minimum data block group number must be 1. When you edit the data block, you set the maximum group number. When you upload/download data to the PT or PLC, the PT or PLC uses the setting of data block number address to read/write the data of data block group. When you edit the data block, you set the size of each group of data block. The NP-series PT has a space of 64k words for the data block.

■ Data Block Address (R/W): RCP

The data block size is L and the data block group number is N.

Word access: RCPn (n: 0 to NxL+(L-1))

Bit access: RCPn.b (n: 0 to NxL+(L-1), b: 0 to 15)

The data block address saves the data block that you uploaded from the PT after you exit the NP-Designer.

There are two methods to read/write these addresses:

Assume that the set data block size is L and the data block group number is N:

Use one of two methods below to access data that are set with data block.

1. Use RCPNO and RCP0 to RCP(L-1)

2. Use the equation: RCP{n×L+(m-1)}

Example of how to access data:

Setting the size L to 2 and the number of groups N to 3 with the data block.

	W1	W2
1	11	22
2	33	44
3	55	66

The data block size L is 2. Thus the data for RCPNO value will be stored in the RCP0 and RCP1, which are the first two addresses from the starting data block address.

The value of RCPNO is 1

Data Block Address	RCP0	RCP1
Data	11	22

Data of the group number 1 is stored.

The value of RCPNO is updated to 3.

Data Block Address	RCP0	RCP1
Data	55	66

The value of data block address will be updated to data of the group number 3.

Data will be stored in the data block address of RCP2 or later as follows.

Data Block Address	RCP2	RCP3	RCP4	RCP5	RCP6	RCP7
Data	11	22	33	44	55	66

Data of the mth word of nth data block will be stored in $RCP\{n \times L + (m-1)\}$.

Thus data "55" (the first word of the group number 3) will be stored in $RCP\{3 \times 2 + (1-1)\} = RCP6$.

Use one of the methods below to change data "55" of the first word of group number 3.

1. Set the value of RCPNO to 3. Then change the value of RCP0.
2. Change the value of RCP6.

SECTION 7



Maintenance and Troubleshooting

This section describes the maintenance and inspection methods for preventing errors occurring, and troubleshooting measures when errors occur in the PT.

7-1	Maintenance	228
7-2	Inspection and Cleaning	231
7-3	Troubleshooting	233
7-3-1	Errors	233
7-3-2	Error Messages.	235
7-4	Requesting a Replacement PT	237

7-1 Maintenance

Perform maintenance operations to maintain the PT in optimum condition.

 WARNING	
After the NP-series PT has been installed, qualified personnel must confirm the installation, and must conduct test operations and maintenance. The qualified personnel must be qualified and authorized to secure safety at each phases of design, installation, running, maintenance, and disposal of system.	
Do not dismantle, repair, or modify the product. Doing so may lead to loss of safety functions.	

Backing up Project Data

Always create a backup of project data and store it in a safe place when the PT malfunctions and needs to be sent out for repair, or when replacing the PT.

Spare PTs

Prepare a spare PT to allow quick recovery of the system at such times as when the PT malfunctions, or the service life of the backlight has expired causing poor screen visibility.

Backlight

The backlight must be replaced when the brightness of the display backlight dims and the display becomes difficult to see. The backlight cannot be replaced by the user.

Contact your nearest OMRON representative.

Backlight Replacement Guidelines

Replace the backlight according to the following guidelines under normal conditions.

After 50,000 hours of using NP5 at room temperature and humidity, (or after approximately 40,000 hours if an NP3 is used. (when the luminous intensity is decreased by 40% per LED))

The service life of the backlight will be especially shortened if used in a low-temperature environment. Replace the backlight when the brightness dims and the display becomes difficult to see.

Precautions for Safe Use

The backlights of PTs cannot be replaced by the user. Contact your nearest OMRON representative.

Replacing the Battery

Use a lithium battery to back up data other than screen data, such as calendar, clock, and log data.

The battery service life is approximately five years at 25°C. The service life will be shortened if the battery is used at higher temperatures. After backing up the data, replace the battery periodically, according to the operating environment.

Keep a spare battery available, so that the battery can be replaced immediately when required.

Battery Models

Manufacturer	Model
OMRON	CJ1W-BAT01

Replacement Guidelines

The guidelines for replacing the battery are as follows:

- Replace when five years have lapsed since a new battery was installed in the PT.
Replace when a message of battery replacement is displayed on the PT.

Replacement Method

Perform the following procedure to replace the battery.
Prepare a new battery.

1,2,3...

1. Open the System Menu. Press the **Setting - Backup**.
2. Turn OFF the power to the PT.
3. Open the battery cover on the rear panel of the PT.
4. Remove the battery that is secured inside the PT, grasp the cable, and pull the connector out to remove it.

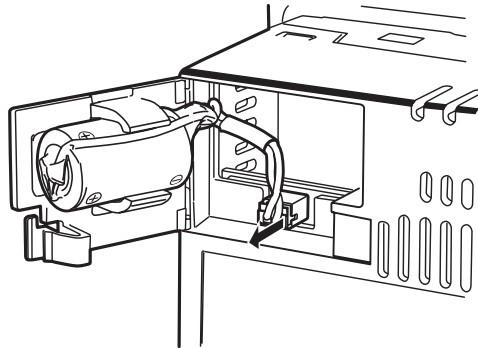

5. Connect the new battery connector, and insert the battery into the battery holder in the battery cover.
Make sure that the lead wire of the battery is placed to contact the upper side of the holder as shown in the Figure 2.

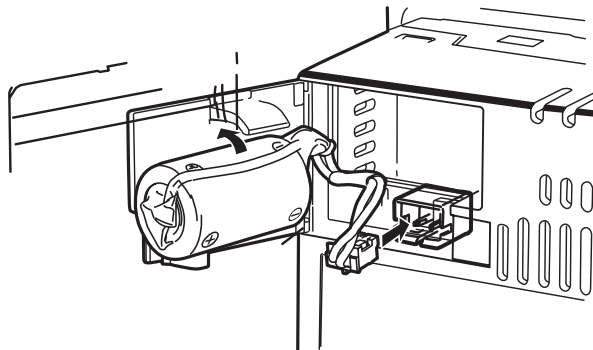

Figure 1

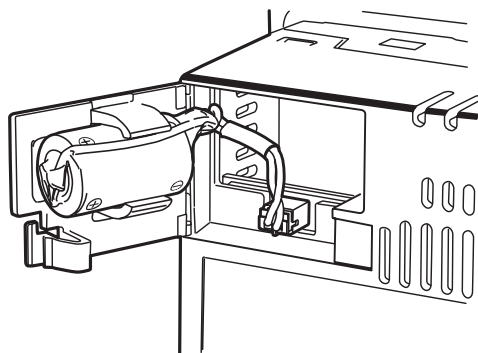

Figure 2

6. Close the battery cover, being careful not to squash the battery cable.

**Precautions
for Correct Use**

Backup data will be restored automatically after replacing the battery.

**Precautions
for Safe Use**



- Never use batteries that have been subjected to a severe shock, such as being dropped on the ground. Batteries subjected to shock may leak.
- When mounting the battery, be sure to use the correct battery and mount it correctly.
- If the battery is removed, the data stored in the PT will be deleted.
- Do not attempt to disassemble or short-circuit the battery.

**The following data will
be saved.**

- Password
- Brightness and contrast
- Refresh rate
- Buzzer
- Screen Saver Time
- Startup delay time
- Default language
- PT internal memory
- Communication parameter

7-2 Inspection and Cleaning

Clean and inspect the PT periodically to maintain it in optimum condition for use.

 WARNING	
<p>After installing the NP-series PT, qualified personnel must confirm the installation, and must conduct test operations and maintenance.</p> <p>The qualified personnel must be qualified and authorized to secure safety at each phases of design, installation, running, maintenance, and disposal of system.</p>	

Cleaning Methods

The screen visibility will be impaired if the display becomes dirty. Clean the display periodically using the following methods:

- For daily cleaning, wipe with a soft, dry cloth. Attempting to remove heavy dirt with the cloth may scratch the front panel sheet. Use a damp cloth and wipe the surface again to remove dirt.
- If dirt cannot be removed using a dry cloth, dampen the cloth sufficiently with a neutral cleaning agent solution (approximately 2%), squeeze the cloth out, and then wipe the surface.
- Materials such as rubber, vinyl, or tape that are attached to the PT will leave stains if left for a long time. If such material is attached to the PT, remove when cleaning.

Precautions for Safe Use

Never use benzene, thinner, or other volatile solvents, or chemical cloths to clean the PT.

Inspection Methods

Inspect the PT once every six to twelve months. Shorten the interval between inspections when using the PT in extreme conditions, such as under high temperatures, high humidity, or environments subject to large quantities of dust.

Inspection Items

Inspect the PT for the following items to check whether the PT is operating within the specified criteria. If the PT is outside the criteria, use measures such as improving the operating environment to conform to the standards, or tightening screws.

Inspection items	Inspection details	Criteria	Inspection means
Power supply	Power terminal voltage fluctuation	Allowable voltage range (24 VDC -10% to +15%)	Tester
Ambient environment	Ambient temperature (temperature in control panel)	0 to 50°C (Refer to <i>Appendix A Specifications.</i>)	Thermometer
	Ambient humidity (temperature in control panel)	35% to 85% RH (Refer to <i>Appendix A Specifications.</i>)	Temperature meter
	Presence of dust	No dust accumulated.	Visual inspection
	Presence of oil	No oil between front panel sheet and molding.	Visual inspection

Inspection items	Inspection details	Criteria	Inspection means
Mounting conditions	Looseness of fixed mounting bracket	Specified torque.	Phillips screwdriver
	Connection status of Connecting Cable Connectors	Fully inserted, locked, and with No looseness.	Phillips screwdriver
	Looseness of external wiring screws	No looseness.	Phillips screwdriver
	Status of external connecting cables	No breaks or other damage	Visual inspection, tester
Parts with limited service life	Backlight brightness	Sufficient brightness. Backlight life of NP5 (at room temperature of 25°C) is 50,000 hours, NP3 is 40,000 hours (when the luminous intensity is decreased by 40% per LED) as a guideline.	Visual inspection
	Battery	5 years (at room temperature of 25°C).	Replace every 5 years

Precautions for Safe Use

- Do not disassemble, repair, or modify the PT.
- Follow all local government regulations, where applicable, when disposing of the PT and used batteries.
- The Unit may not be usable in locations subject to long-term exposure to oil or water. The gasket will deteriorate after long-time use. Inspect the gasket on a regular basis. If deterioration is found, contact your OMRON representative.

7-3 Troubleshooting

This section describes countermeasures for errors.

7-3-1 Errors

If an error occurs during PT operation, find the symptoms of the error on the following table and then perform the suggested countermeasures.

Precautions for Safe Use

Check that the system is safe before turning the power ON/OFF.
Do not dismantle, repair, or modify NP-series PTs.

Errors during Data Transfer

Symptoms	Cause	Possible countermeasure
Cannot execute serial data transfer.	Not connected to NP-Designer.	Check the connection cable wiring. (Refer to 3-3 <i>Connecting the NP-Designer</i>)
	The transfer setting of NP-Designer is set to USB.	Set the Transfer Setting to PC COM Port in Option Dialog Box from Tools Menu of the NP-Designer.
	The PT is not in the transfer mode.	Set the PT to the transfer mode. (Refer to SECTION 4 <i>System Menu</i> .)
Personal computer cannot detect PT when connected via USB.	A malfunction has occurred due to external noise.	Configure the USB Hub and wire the USB cables taking measures to prevent noise.
Timeout occurs during screen transfer using USB.	The transfer setting of NP-Designer is set to PC COM port.	Set the Transfer Setting to USB in Option Dialog Box from Tools Menu of the NP-Designer.
	A malfunction has occurred due to external noise.	Configure the USB Hub and wire the USB cables taking measures to prevent noise.
<i>Open File Fail</i> was displayed on the PT.	No USB flash memory is connected to the PT even though saving data to USB flash memory was specified.	Connect USB flash memory to the PT or change the PT settings from the NP-Designer to save data to SRAM rather than USB flash memory.

Errors at PT Startup

Symptoms	Cause	Possible countermeasure
Indicators are not lit.	Power not supplied to the PT.	Check the connections and supply power correctly to the PT. (Refer to 3-1 <i>Installing the PT</i> .)
	Power supply fuse broken.	The PT must be repaired. Contact your nearest OMRON representative.
	System program corrupted. (Fatal error.)	The PT may be faulty. Contact your nearest OMRON representative.
The indicator is lit green and the screen is blank.	Backlight failure.	The backlight must be replaced. Contact your nearest OMRON representative.

Errors When Connecting the Host

Symptoms	Cause	Possible countermeasure
Cannot connect to host. (An error message is displayed.)	A malfunction has occurred due to external noise.	Wire the cable according to noise prevention measures.
	Protocol settings for the host and PT settings do not match.	Use NP-Designer to make communications settings.
	PT and host are not connected properly.	Check that the type of connection cable, the length, and the wiring meet the specifications. (Refer to <i>1-2 Communications with the Host</i>)
	For 1:N NT Links, a duplicate unit number has been used.	With an NP-series PT, only one PT can be connected to each PLC port even if the 1:N NT Link protocol is used. Two or more PTs cannot be connected. (Refer to <i>3-5 Connecting with 1:N NT Links</i>)

Errors during PT Operation

Symptoms	Cause	Possible countermeasure
RUN indicator does not light.	Power is not being supplied to the PT.	Check the connections and supply power to the PT correctly. (Refer to <i>3-1 Installing the PT.</i>)
	The fuse is broken.	The PT must be repaired. Contact your nearest OMRON representative.
The screen is blank.	The screen saver function is operating.	This is not an error. Touch the screen.
	The backlight has malfunctioned.	The backlight must be replaced. Contact your nearest OMRON representative.
The display update is slow.	Screen switching or opening and closing pop-up screens are being performed frequently.	If screens are switched, opened and closed frequently, the display update may take some time and communications may be delayed. Adjust the interval between screen switches so that the system is not overloaded.
The touch panel does not respond.	PT has malfunctioned due to external noise.	Reset the PT, and wire it according to noise prevention measures.
	The touch panel is damaged.	If there is an abnormal symptom, contact your nearest OMRON representative.
The display is dark.	The brightness setting is too low.	Increase the backlight brightness in the LCD of the System Menu. With some models of NP-series PTs, the backlight brightness cannot be adjusted. Please check the specifications.
	The backlight is faulty or its service life has expired.	The backlight must be replaced. Contact your nearest OMRON representative.
Cannot connect to a Programming Console	Host settings are incorrect.	Check the host settings. Use NT Link 1:N (normal or high-speed) and set the maximum unit number to 0.
<i>Device Not Support</i> was displayed on the PT.	The USB flash memory could not be detected.	<ul style="list-style-type: none"> • Format the USB flash memory in FAT32 format. • Check to see if the USB flash memory is damaged.

Errors During Object Operation

Symptoms	Cause	Possible countermeasure
The numerical and character string update is slow.	Communications are unstable due to external noise.	Perform noise countermeasures such as separating communications cables from power lines.
	There are too many numeric display, numeric input, string display and string input objects in the display.	Reduce the number of numeric display, numeric input, string display and string input objects in the screen where update is slow.
	For RS-422A communications, the branch is incorrect or the terminating resistance is not set properly.	Wire correctly, referring to <i>Appendix C Connecting to RS-422A/485</i> .
Some objects in the screen are not displayed.	A communications error has occurred.	Check the communications settings.
The log graph display does not match the actual log timing.	The communications address set for the event of log timing is turning ON and OFF at high speed.	Set the ON/OFF cycle of the communications address for events to a longer time.
Cannot input numerical values.	The numerical value input upper and lower limit check function is running.	Select Detail in the Property of the input object with NP-Designer and check the Minimum and Maximum values. Then correct them if necessary.
Cannot input to any object. Or the function is not executed.	A password has been set.	Input the password in the password input dialog box that is displayed.
Cannot switch to System Menu.	A function that can switch a screen to System Menu is not allocated.	Use the Function Switch or button to set a function that can switch a screen to System Menu.

7-3-2 Error Messages

If the messages listed on the following table are displayed on the computer, find the symptoms of the error below and then perform the suggested countermeasures.

Troubleshooting Screen Data Transfers between Computer (NP-Designer) and PT

This section describes possible errors during data transfer and their countermeasures.

Message	Cause	Countermeasure
Incorrect Model Name	Models of the screen and PT do not match.	Check the model with PT Setting Dialog from PT Menu of the NP-Designer.
Connection failed	Time-out occurs while connecting to the PT or transferring.	Check the following. <ul style="list-style-type: none"> • Power supply to the PT • Cable connections (If this symptom still occurs, exit the application and restart the computer and PT. Then connect them again.)

Message	Cause	Countermeasure
No Response From PT	<ul style="list-style-type: none"> • Attempted to transfer screen data using a method different from the transfer setting. • When attempted to transfer screen data through COM port, the PT was not in a transfer mode. • The SW1 slide switch on the back of the PT is turned ON. • The PT is busy. 	<ul style="list-style-type: none"> • Check the transfer setting in the Option Dialog from Tools Menu of the NP-Designer. • To transfer screen data through COM Port, the PT must be in a transfer mode. (Refer to SECTION 4 System Menu) • Turn OFF SW1 slide switch on the back of the PT before transferring screen data. • Restart the PT and transfer screen data.
Transmission aborted	Time-out occurs while connecting to the PT or transferring.	<p>Check the following.</p> <ul style="list-style-type: none"> • Power supply to the PT • Cable connections (If this symptom still occurs, exit the application and restart the computer and PT. Then connect them again.) <p>There was possibly a load on communication retries between the PT and host. (If this symptom still occurs, format the PT flash ROM and transfer the screen data again.)</p>

NP-Designer Error Messages

This section describes possible errors during screen data editing and their countermeasures.

Message	Cause	Countermeasure
The system cannot find the path specified.	The output path for a file that was output by an error check, test function, file transfer, etc., is not correct.	Check the output path in the Option Dialog from the Tools Menu of the NP-Designer, and specify it correctly.
The system cannot find the file specified. (When starting NP-Designer).	When NP-Designer was started, it automatically tried to open the project that was edited most recently, and the file was not found.	---

7-4 Requesting a Replacement PT

Always observe the following precautions when faults are detected during inspection and the PT is to be replaced.

- Create a backup of the PT project data.
Project data may be deleted when the PT is repaired by OMRON.
- Always turn OFF the power before replacing the PT.
- After replacing the PT, check to confirm that the new PT has no faults.
- When returning a faulty PT for repair, include a document with the PT that provides as many details on the fault as possible, and send to your OMRON representative.

Appendices

Appendix A	Specifications	241
Appendix B	Dimensions	245
Appendix C	Connecting to RS-422A/485	249
Appendix D	Preparing Connecting Cables	251
Appendix E	Standard Models	257
Appendix F	List of Optional Products	271

Appendix A

Specifications

General Specifications

Item	Specifications		
	NP5-SQ000B/NP5-SQ000 NP5-SQ001B/NP5-SQ001	NP5-MQ000B/NP5-MQ000 NP5-MQ001B/NP5-MQ001	NP3-MQ000B/NP3-MQ000 NP3-MQ001B/NP3-MQ001
Rated power supply voltage	24 VDC		
Allowable voltage range	21.6 to 27.6 VDC (24 VDC -10% to +15%)		
Allowable input power interruption time	No restriction.		
Power consumption	12 W max.		
Ambient operating temperature	0 to 50°C (See notes 1 and 2.)		
Storage temperature	-20 to +60°C (See note 2.)		
Ambient operating humidity	35 to 85%RH with no condensation (0 to 40°C) (See notes 2.) 35 to 50%RH with no condensation (40 to 50°C) (See notes 2.)		
Operating environment	No corrosive gases.		
Noise immunity	Conforms to IEC61000-4-4, 2 KV (power lines)		
Vibration resistance (during operation)	5 to 9 Hz with 3.1 mm amplitude and 9 to 150 Hz with 9.8 m/s ² acceleration for 30 min in each of X, Y, and Z directions		
Shock resistance (during operation)	147 m/s ² 3 times in each of X, Y, and Z directions.		
Dimensions	184.1 × 144.1 × 52.3 mm (W × H × D)		130.1 × 104.8 × 55.4 mm (W × H × D)
Panel cutout dimensions	Width 172.4 ₀ ⁺¹ × Height 132.4 ₀ ⁺¹ mm Panel thickness: 1.6 to 2.5 mm		Width 118.5 ₀ ⁺¹ × Height 92.5 ₀ ⁺¹ mm Panel thickness: 1.6 to 2.5 mm
Weight	900 g max.		500 g max.
Enclosure rating	Front panel: IP65 Oil-proof type (See note 3.)		
Battery life	5 years (at 25°C) (See note 4.)		
International standards	EC Directives UL508		

Note (1) When a STN LCD display device is used, the display quality will decline (e.g., the contrast ratio will be reduced) if the temperature exceeds 40°C. Also, when the temperature drops, the response speed is lowered due to characteristics of liquid crystals.

(2) Operate the PT within the temperature and humidity ranges shown in the following diagram.

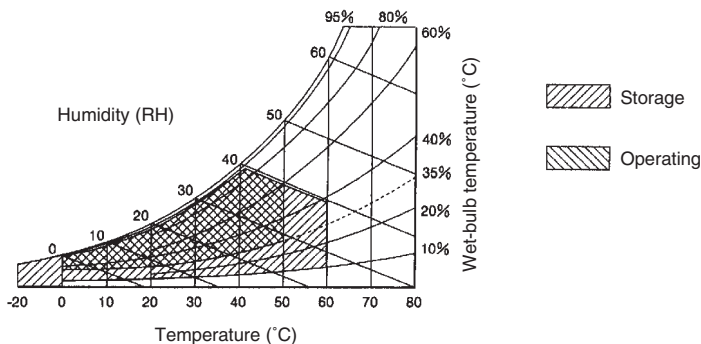

- (3) The Unit may not be usable in locations subject to long-term exposure to oil or water. The gasket will deteriorate after long-time use. Inspect the gasket on a regular basis. If deterioration is found, contact your OMRON representative.
- (4) If the battery is removed, data in the PT will be deleted.

Characteristics

Display Specifications

Item		Specifications		
		NP5-SQ000B NP5-SQ000 NP5-SQ001B NP5-SQ001	NP5-MQ000B NP5-MQ000 NP5-MQ001B NP5-MQ001	NP3-MQ000B NP3-MQ000 NP3-MQ001B NP3-MQ001
Display panel (See note 3.)	Display device	5.7FSTN LCD		3.8STN LCD
	Number of dots	320 dot horizontal × 240 dot vertical		
	Display color	256 colors	Monochrome/8 grayscale levels	
	Display area	Width 121.4 mm × height 92.6 mm (5.7 inches)		Width 78.8 mm × height 59.6 mm (3.8 inches)
	View angle	Left/right ±30°, Top 10°, Bottom 30°		Left/right ±30°, Top 10°, Bottom 30°
Backlight	Life expectancy	50,000 hours min. (See note 2.)		40,000 hours min. (See note 1.)
	Brightness adjustment	Cannot be adjusted		There are 19 levels of adjustment by operating the touch panel.
	Backlight error detection	No detection function.		
Front panel indicators		Lit: The power is turned to ON Unlit: The power is turned to OFF		

- Note**
- (1) This is the estimated time when the luminous intensity is decreased by 40% per LED at room temperature and humidity. It is not a guaranteed value.
 - (2) The life expectancy is given only as a guideline. It is not a guaranteed value. The life of the backlight will be much shorter at low temperatures.
 - (3) There may be some defective pixels in the display. This is not a fault as long as the numbers of defective light and dark pixels fall within the following standard ranges.
Number of light and dark pixels: $0.2 < (\text{minor axis} + \text{major axis}) / 2 \leq 0.55 \text{ mm}$ (within 1 per 20-mm square)

Operating Specifications

item		Specifications		
		NP5-SQ000B NP5-SQ000 NP5-SQ001B NP5-SQ001	NP5-MQ000B NP5-MQ000 NP5-MQ001B NP5-MQ001	NP3-MQ000B NP3-MQ000 NP3-MQ001B NP3-MQ001
Touch panel (Analogue type) (See notes 1 and 2.)	Method: Resistive membrane			
	Resolution: 1024 × 1024			
	Input: Pressure-sensitive			
	Service life: 1,000,000 touch operations.			

- Note**
- (1) The display is analogue resistive membrane. When two or more points are pressed on the display simultaneously, a switch between these points may be operated. Do not press two or more points at the same time.
 - (2) The specifications are the same for the function switches.

External Interface Specifications

Item	Specifications		
	NP5-SQ000B NP5-SQ000 NP5-SQ001B NP5-SQ001	NP5-MQ000B NP5-MQ000 NP5-MQ001B NP5-MQ001	NP3-MQ000B NP3-MQ000 NP3-MQ001B NP3-MQ001
USB HOST	1 port (for connecting USB memory)		
USB Slave	1 port (screen data transfer, connected to personal computer)		

Programming Device (Software for Creating Screen Data)

Item	Specifications
Name	NP-Designer
Model	NP-NPDC0-V1

Communications Specifications**Serial Communications**

Item	Specifications
COM1	Conforms to EIA RS-232C D-Sub female 9-pin connector 5VDC output (250 mA max.) through pin 6
COM2	Conforms to EIA RS-422A, RS-485. 10-pin terminal block

1:1 NT Link

Item	Specifications	
Communications standards	Conforms to EIA RS-232C	Conforms to EIA RS-422A/485
Connectors	D-Sub female 9-pin connector	10-pin terminal block
Number of Units connected	1:1	1:1
Transmission distance	Up to 15 m.	Up to 500 m.

1:N NT Links

Item	Specifications	
Communications standards	Conforms to EIA RS-232C.	Conforms to EIA RS-422A/485
Connectors	D-Sub female 9-pin connector	10-pin terminal block
Number of Units connected	1:1	1:1
Transmission distance	Up to 15 m.	Up to 500 m.

Appendix B

Dimensions

NP5-□Q000(B) (Includes Mounting Dimensions)

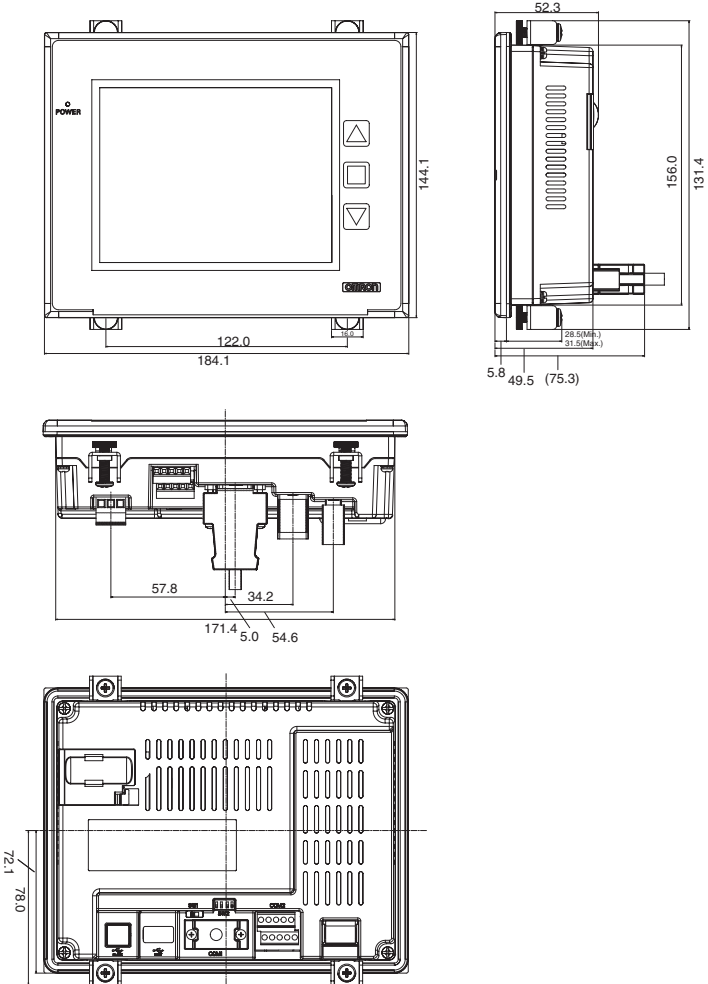

NP5-□Q001(B)

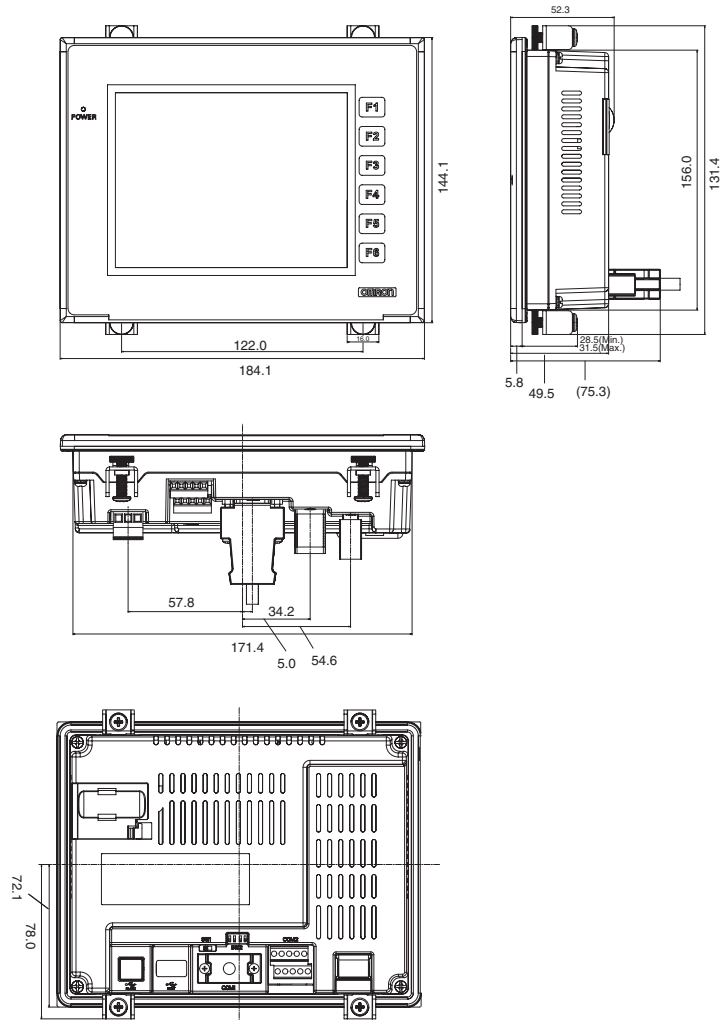

NP3-□Q00(B) (Includes Mounting Dimensions)

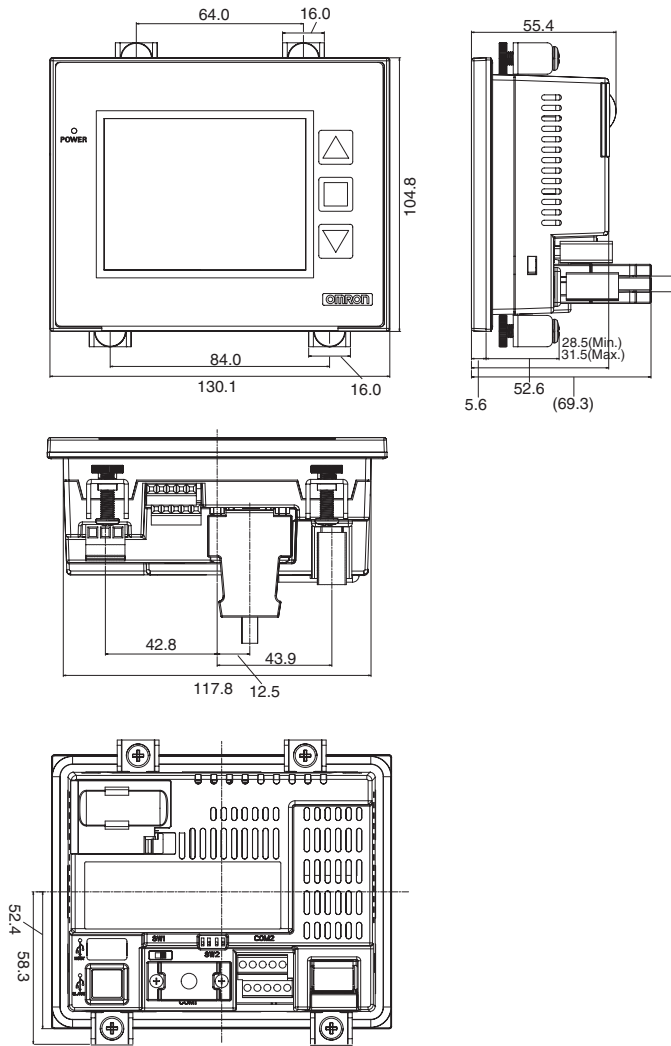

NP3-□Q001(B)

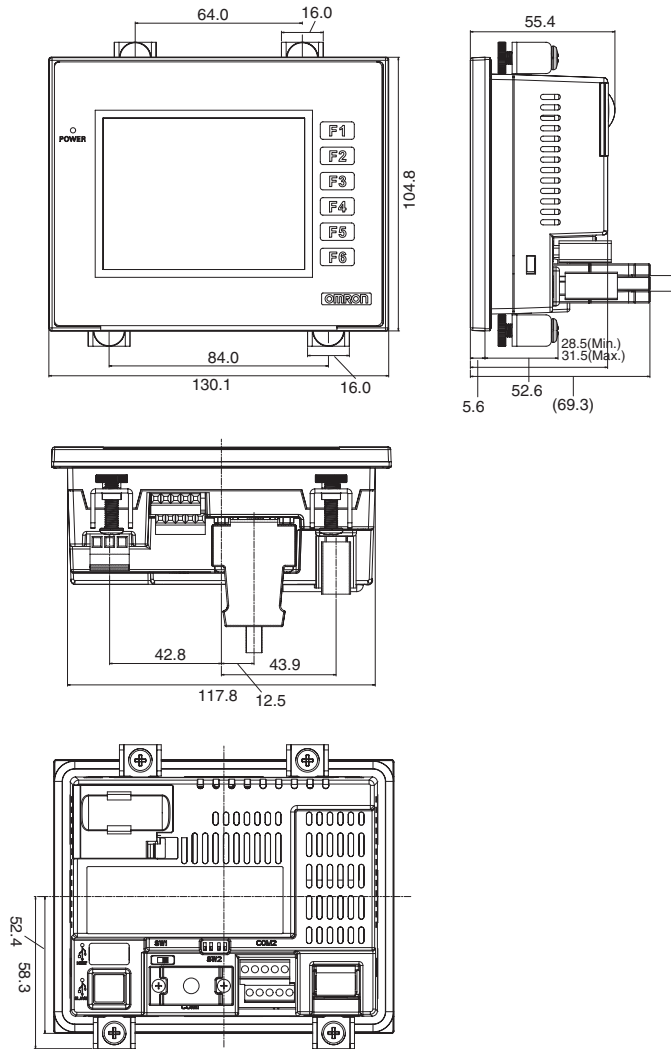

Appendix C

Connecting to RS-422A/485

Handling the Shield on RS-422A/485 Cables

Perform the following procedures to connect, process the shield, and connect to ground for communications using RS-422A or RS-485.

Connecting the Ground Wire

The PT has a functional ground terminal (FG: ⏏).

1. Ground according to Figure (a) for normal grounding.
 - Connect the ground terminal (GR) of the devices to the functional ground (FG: ⏏).
 - Make sure that each signal line is grounded at only one point and ground to 100 W max.
 - Short the LG terminal of the PLC to the ground terminal (GR).
 - Use a wire gauge of at least 2 mm² for the ground wire.
 - Refer to the manual for individual Communications Units for details on proper wiring procedures.
2. Do not ground the functional ground (FG: ⏏) of the PT if it is mounted to the same panel as devices that generate noise, such as motors or inverters, as shown in Figure (b).

Precautions for Safe Use

Ground correctly to prevent the PT from malfunctioning due to noise.

Preparing the Shield of RS-422A/485 Connectors

Always prepare RS-422A/485 cable shields properly.

Ground only one end of the shield when connecting the ground terminal (GR) of the devices to the functional ground (FG: ⏏), and grounding each signal line at only one point and to 100 W max, as shown in Figure (a).

Ground both ends of the shield when not grounding the functional ground (FG: ⏏) of the PT, as shown in Figure (b).

Precautions for Safe Use

Process the cable shields correctly to prevent the PT from malfunctioning due to noise.

Example of Recommended Wiring

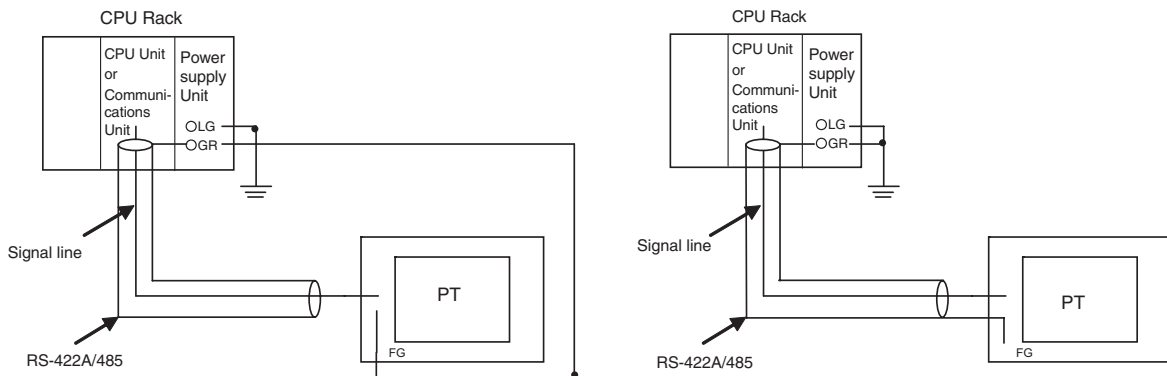

Connection Example

An example of connecting a PLC and a PT using an RS-232C/RS-422A Converter is shown below. Use the wiring example as reference for correct wiring.

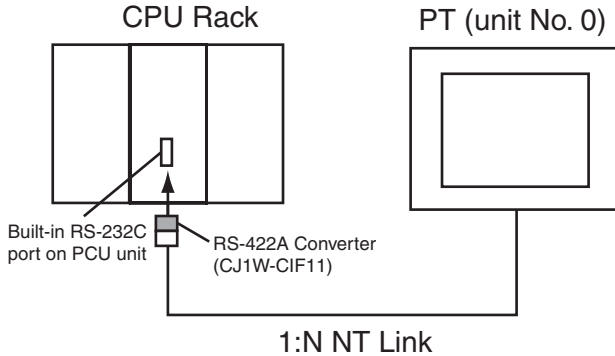

Wiring Example

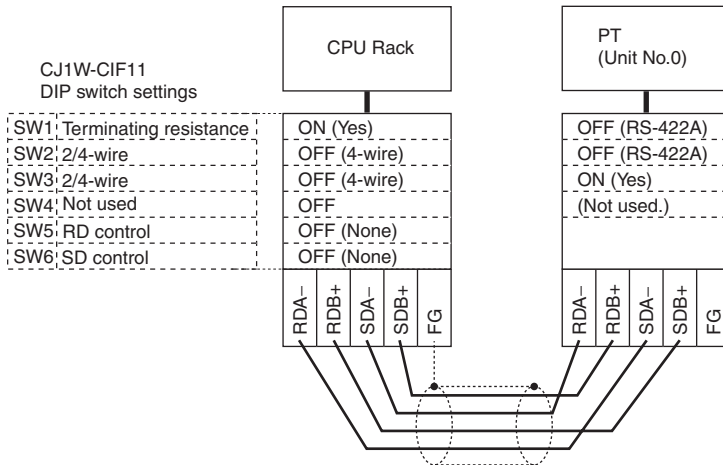

Note Refer to *Handling the Shield on RS-422A/485 Cables* for information on processing the shield wire on the RS-422A/485 cable.

Use the following connection cables.

Manufacturer	Model
Tachii Electric Wire Co., Ltd.	TKV VBS3P-03
HIRAKAWA HEWTECH CORP.	CO-HC-ESV-3P×7/0.2

Appendix D

Preparing Connecting Cables

Use the following procedure to prepare connecting cables.

Cable Preparation

1. Cut the cables to the required length.
2. Remove the vinyl cable covering using a razor blade or other tool. Use care not to damage the shield (braided mesh).
3. Cut the shield using scissors.
4. Strip back to the core of each wire using a stripper.
5. Bend back the shields.
6. Wrap the section of the shields that is bent back with aluminum foil tape.

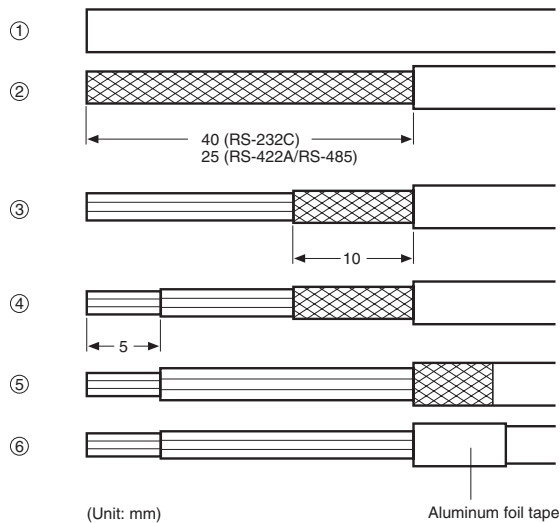

Soldering

1. Pass a heat-shrinking tube over each wire.
2. Pre-solder each wire and connector terminal.
3. Solder each of the wires to the connector terminals.

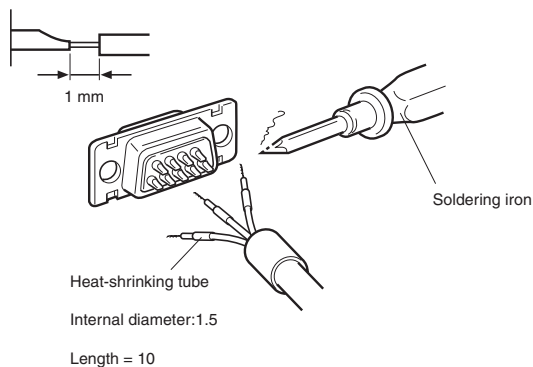

- Replace the heat-shrinking tube up to the soldered section, and shrink the tube onto the wire by applying heat using a soldering gun.

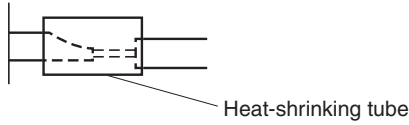

Hood Assembly

Assemble the hood as shown in the following diagram.

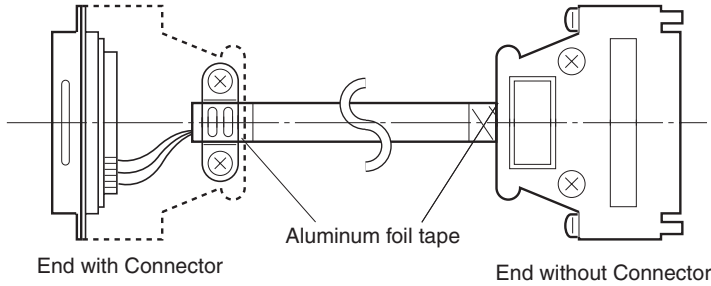

Preparing Connecting Cables for Host Connection

Refer to the following information when preparing the connecting cables for connecting the PT to the host.

Wiring Layout between PT COM1 Serial Port and Host (RS-232C)

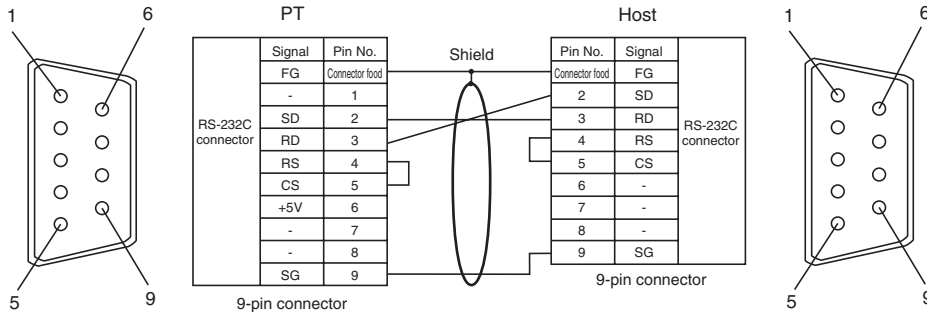

Wiring Layout between PT COM2 Serial Port and Host (RS-422A)

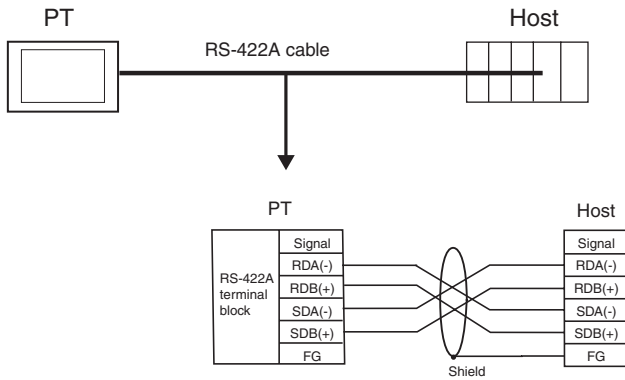

When connecting individual signals with twisted-pair cable, connect RDA and RDB, and SDA and SDB, as pairs in the twisted-pair cable. A communications error may occur if the pairs are not combined correctly.

Wiring Layout between PT Serial Port COM2 and Host (RS-485)

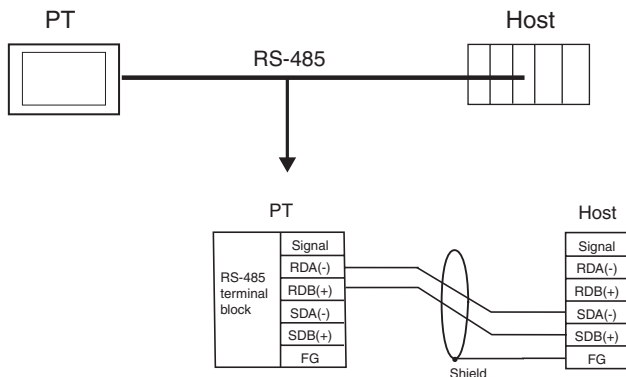

Wiring Layout to CS1G/H Serial Communications Boards, C200HX/HG/HE(-Z) Communications Boards, CQM1H Serial Communications Boards, and CVM1/CV Series Host Link Units

Applicable Units:

- CS1G-CPU42(-V1), CS1G-CPU43(-V1), CS1G-CPU44(-V1),
- CS1G-CPU45(-V1), CS1H-CPU63(-V1), CS1H-CPU64(-V1),
- CS1H-CPU65(-V1), CS1H-CPU66(-V1), CS1H-CPU67(-V1),
- C200HE-CPU32(-Z), C200HE-CPU42(-Z), C200HG-CPU33(-Z),
- C200HG-CPU43(-Z), C200HG-CPU53(-Z), C200HG-CPU63(-Z),
- C200HX-CPU34(-Z), C200HX-CPU44(-Z), C200HX-CPU54(-Z),
- C200HX-CPU64(-Z), C200HX-CPU65-Z, C200HX-CPU85-Z,
- CQM1H-CPU51, CQM1H-CPU61, CV500-LK201(COM port 2)

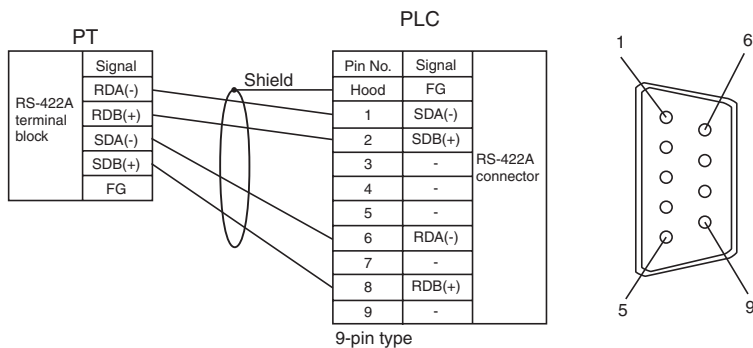

For details on processing shielded cable, refer to *Handling the Shield on RS-422A/485 Cables*.

Wiring Layout to CVM1/CV-series CPU Units

Applicable Units:

- CV500-CPU01-V1, CV1000-CPU01-V1, CV2000-CPU01-V1,
- CVM1-CPU01-V□, CVM1-CPU11-V□, CVM1-CPU21-V□

CVM1/CV Series CPU Units without the -V□ suffix cannot be connected by any communications method.

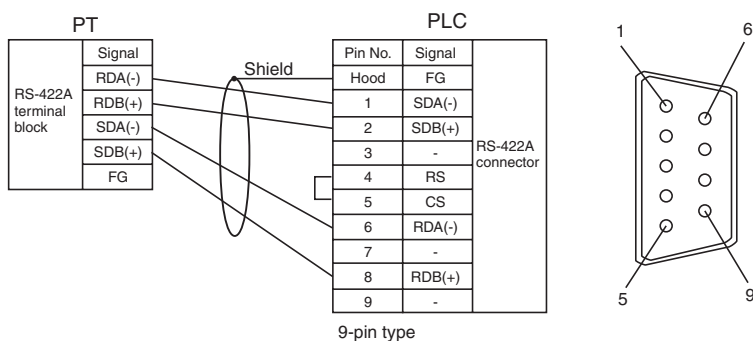

For details on processing shielded cable, refer to *Handling the Shield on RS-422A/485 Cables*.

Wiring Layout to EJ1 Modular Temperature Controller

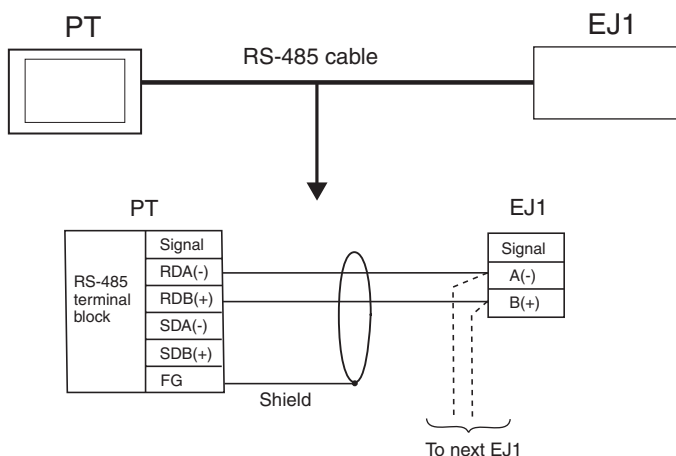

For details on processing shielded cable, refer to *Handling the Shield on RS-422A/485 Cables*.

Preparing Cables for Computer Connection

Refer to the following information when preparing the NP-Designer connecting cables.

Wire the RS-232C connector to the DOS computer according to the type, as follows:

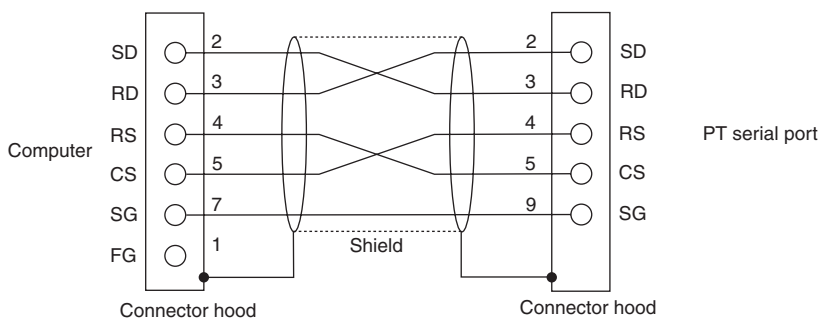

Use the following products to assemble the connecting cable.

Name	Model	Details
Connector	XM2D-2501	25-pin type Manufactured by OMRON (computer side)
	XM2A-0901	9-pin type Manufactured by OMRON (PT side)

Name	Model	Details
Connector hood	XM2S-2511	25-pin type Manufactured by OMRON (computer side)
	XM2S-0911	9-pin type, mm screws Manufactured by OMRON (PT side)
Cable	AWG28 × 5P IFVV-SB	Multiconductor shielded cable Manufactured by Fujikura Densen.
	CO-MA-VV-SB 5P × 28AWG	Multiconductor shielded cable Manufactured by Hitachi Densen.

9-pin Connector

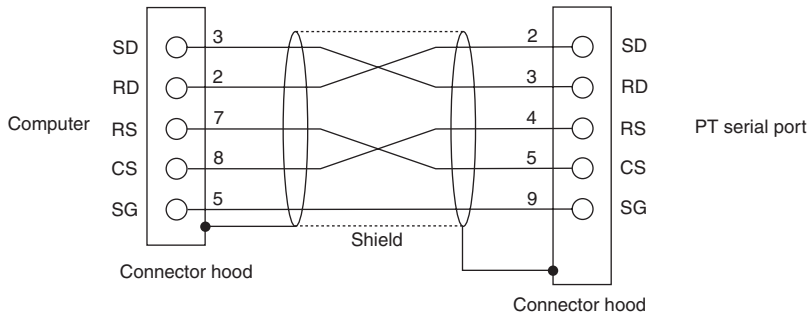

Use the following products to assemble the connecting cable.

Name	Model	Details
Connector	XM2D-0901	9-pin type Manufactured by OMRON (computer side)
	XM2A-0901	9-pin type Manufactured by OMRON (PT side)
Connector hood (See note.)	XM2S-0911	9-pin type, mm screws Manufactured by OMRON.
	XM2S-0913	9-pin type, inch screws Manufactured by OMRON.
Cable	AWG28 × 5P IFVV-SB	Multiconductor shielded cable Manufactured by Fujikura Densen.
	CO-MA-VV-SB 5P × 28AWG	Multiconductor shielded cable Manufactured by Hitachi Densen.

Note Use a connector hood for the computer that conforms to the standards for the screws of the computer connector.

Appendix E

Standard Models

Programmable Terminals (PTs)

Model	LCD				Case
	Type	Size	Color	Number of dots	Color
NP5-SQ000B	FSTN	5.7 inch	256 colors	320 × 240	Black
NP5-SQ000	FSTN	5.7 inch	256 colors	320 × 240	Silver
NP5-SQ001B	FSTN	5.7 inch	256 colors	320 × 240	Black
NP5-SQ001	FSTN	5.7 inch	256 colors	320 × 240	Silver
NP5-MQ000B	FSTN	5.7 inch	Monochrome	320 × 240	Black
NP5-MQ000	FSTN	5.7 inch	Monochrome	320 × 240	Silver
NP5-MQ001B	FSTN	5.7 inch	Monochrome	320 × 240	Black
NP5-MQ001	FSTN	5.7 inch	Monochrome	320 × 240	Silver
NP3-MQ000B	STN	3.8 inch	Monochrome	320 × 240	Black
NP3-MQ000	STN	3.8 inch	Monochrome	320 × 240	Silver
NP3-MQ001B	STN	3.8 inch	Monochrome	320 × 240	Black
NP3-MQ001	STN	3.8 inch	Monochrome	320 × 240	Silver

Serial Communications Units

Model	Specifications	Applicable PLC
CS1W-SCU21	<ul style="list-style-type: none"> • RS-232C (2 ports) • Base-mounting type 	CS-series CS1G/H and CS1G/H-H
CS1W-SCU41	<ul style="list-style-type: none"> • RS-232C (1 port) • RS-422A (1 port) • Base-mounting type 	CS-series CS1G/H and CS1G/H-H
CJ1W-SCU41	<ul style="list-style-type: none"> • RS-232C (1 port) • RS-422A (1 port) • Building-block type 	CJ-series CJ1G/H-H and CJ1M

CPU Units That Connect to PTs in 1:1 NT Links

PLC Series	Specifications
C200HE/HG/HX Series	With RS-232C connector (switching/9-pin type)
CQM1(H) Series	With RS-232C connector (9-pin type)
CPM1A Series	Connects to RS-232C cable using RS-232C Adapter CPM1-CIF01.
CPM2A Series	With RS-232C connector (9-pin type)
CPM2C Series	Connects to RS-232C connector branched using CPM2C-CN111 with converting cable.
CVM1/CV Series	With RS-232C connector (switching/9-pin type)

CPU Units That Connect in 1:1 NT Links via RS-232C to PT Serial Ports

PLC Series	CPU Units with built-in 1:1 NT Link functionality	CPU Units that connect via optional Communications Boards
C Series	C200HE-CPU42 (-Z)	C200HE-CPU32 (-Z) (See note 1.) C200HE-CPU42 (-Z) (See note 1.)

PLC Series	CPU Units with built-in 1:1 NT Link functionality	CPU Units that connect via optional Communications Boards
C Series	C200HG-CPU43(-Z) C200HG-CPU63(-Z)	C200HG-CPU33(-Z) (See note 1.) C200HG-CPU43(-Z) (See note 1.) C200HG-CPU53(-Z) (See note 1.) C200HG-CPU63(-Z) (See note 1.)
	C200HX-CPU44(-Z) C200HX-CPU64(-Z) C200HX-CPU65-Z C200HX-CPU85-Z	C200HX-CPU34(-Z) (See note 1.) C200HX-CPU44(-Z) (See note 1.) C200HX-CPU54(-Z) (See note 1.) C200HX-CPU64(-Z) (See note 1.) C200HX-CPU65-Z C200HX-CPU85-Z
	CQM1-CPU41-V1 CQM1-CPU42-V1 CQM1-CPU43-V1 CQM1-CPU44-V1 CQM1-CPU45-EV1	---
	CPM1A-10CD□-□ (-V1) CPM1A-20CD□-□ (-V1) CPM1A-30CD□-□ (-V1) CPM1A-40CD□-□ (-V1)	---
	CPM2A-30CD□□-□ CPM2A-40CD□□-□ CPM2A-60CD□□-□	---
	CPM2C-10□□□□□□-□ (See note 4.) CPM2C-20□□□□□□-□ (See note 4.)	---
	CQM1H-CPU21 (See note 2.) CQM1H-CPU51 (See note 2.) CQM1H-CPU61 (See note 2.)	---
CV Series (See note 3.)	CV500-CPU01-V1 CV1000-CPU01-V1 CV2000-CPU01-V1	---
CVM1 Series (See note 3.)	CVM1-CPU01-V2 CVM1-CPU11-V2 CVM1-CPU21-V2	---

- Note**
- (1) A C200HW-COM02/COM04/COM05/COM06-V1 Communications Board is required.
 - (2) A CQM1H-SCB41 Serial Communications Board is required.
 - (3) Connection is not possible to CVM1/CV-series PLC CPU Units without “-V1” in the model number.
 - (4) A CS1W-CN118 Conversion Cable or XW2Z-200T-2 Cable with connector must be used for the connection.

Precautions for Correct Use

CS-series CPU Units cannot connect to 1:1 NT Links, but a 1:1 connection can be made using 1:N NT Links (normal or high-speed). Refer to *3-5 Connecting with 1:N NT Links* and *3-6 High-speed 1:N NT Links* for details.

CPU Units That Connect in 1:1 NT Links via RS-422A/485 to PT Serial Ports

PLC Series	CPU Units with built-in 1:1 NT Link functionality
C Series	C200HE-CPU32 (-Z) (See note 1.) C200HE-CPU42 (-Z) (See note 1.)
	C200HG-CPU33 (-Z) (See note 1.) C200HG-CPU43 (-Z) (See note 1.) C200HG-CPU53 (-Z) (See note 1.) C200HG-CPU63 (-Z) (See note 1.)
	C200HX-CPU34 (-Z) (See note 1.) C200HX-CPU44 (-Z) (See note 1.) C200HX-CPU54 (-Z) (See note 1.) C200HX-CPU64 (-Z) (See note 1.) C200HX-CPU65-Z (See note 1.) C200HX-CPU85-Z (See note 1.)
	CQM1H-CPU51 (See note 2.) CQM1H-CPU61 (See note 2.)
	CV Series (See note 3.)
CVM1 Series (See note 3 and 4.)	CVM1-CPU01-V2 CVM1-CPU11-V2 CVM1-CPU21-V2

- Note**
- (1) A C200HW-COM03-V1 or C200HW-COM06-V1 Communications Board is required.
 - (2) A C200HW-COM03-V1 or C200HW-COM06-V1 Communications Board is required.
 - (3) Connection is not possible to CVM1/CV-series PLC CPU Units without “-V1” in the model number.
 - (4) Connect using RS-422A

CPU Units That Connect to PTs in Standard 1:N NT Links

Model	Specifications
CP Series	Connecting to RS-232C cable using RS-232C Option Board (CP1W-CIF01). Connecting RS-422A/485 Option Board (CP1W-CIF11).
C200HE/HG/HX Series	With RS-232C connector (switching/9-pin type)
CQM1H Series	With RS-232C connector (9-pin type)
CS Series	With RS-232C connector (9-pin type)
CJ Series	With RS-232C connector (9-pin type)

CPU Units That Connect in 1:N NT Links via RS-232C to PT Serial Ports

PLC Series	Connecting with built-in ports	Connecting via optional Communications Boards
CP Series	---	CP1L-L14D/L20D/M30D/M40D (See note 1.) CP1H-X/XA/Y
CS Series	CS1G-CPU42(-V1) CS1G-CPU43(-V1) CS1G-CPU44(-V1) CS1G-CPU45(-V1) CS1H-CPU63(-V1) CS1H-CPU64(-V1) CS1H-CPU65(-V1) CS1H-CPU66(-V1) CS1H-CPU67(-V1) CS1G-CPU42H CS1G-CPU43H CS1G-CPU44H CS1G-CPU45H CS1H-CPU63H CS1H-CPU64H CS1H-CPU65H CS1H-CPU66H CS1H-CPU67H CS1D-CPU65H CS1D-CPU67H	Same as at left. (See note 2.)
CJ Series	CJ1H-CPU65H (See note 2.) CJ1H-CPU66H (See note 2.) CJ1G-CPU42H (See note 2.) CJ1G-CPU43H (See note 2.) CJ1G-CPU44H (See note 2.) CJ1G-CPU45H (See note 2.) CJ1M-CPU11 CJ1M-CPU12 CJ1M-CPU13 CJ1M-CPU21 CJ1M-CPU22 CJ1M-CPU23	Same as at left. (See note 3.)
C Series	C200HE-CPU42(-Z)	C200HE-CPU32(-Z) (See note 4.) C200HE-CPU42(-Z) (See note 4.)
	C200HG-CPU43(-Z) C200HG-CPU63(-Z)	C200HG-CPU33(-Z) (See note 4.) C200HG-CPU43(-Z) (See note 4.) C200HG-CPU53(-Z) (See note 4.) C200HG-CPU63(-Z) (See note 4.)
	C200HX-CPU44(-Z) C200HX-CPU64(-Z) C200HX-CPU65-Z C200HX-CPU85-Z	C200HX-CPU34(-Z) (See note 4.) C200HX-CPU44(-Z) (See note 4.) C200HX-CPU54(-Z) (See note 4.) C200HX-CPU64(-Z) (See note 4.) C200HX-CPU65-Z (See note 4.) C200HX-CPU85-Z (See note 4.)
	---	CQM1H-CPU21 (See note 5.) CQM1H-CPU51 (See note 5.) CQM1H-CPU61 (See note 5.)

- Note**
- (1) CP1W-CIF01 RS-232C option board is required.
 - (2) A CS1W-SCB21/SCB41 Serial Communications Board or a CS1W-SCU21 Serial Communications Unit is required.
 - (3) A CJ1W -SCU41 Serial Communications Unit is required.
 - (4) A C200HW-COM02/COM04/COM05/COM06(-V1) Communications Board is required.
 - (5) A CQM1H-SCB41 Serial Communications Board is required.

CPU Units That Connect in 1:N NT Links via RS-442A/485 to PT Serial Ports

PLC Series	Unit	Serial Communications Board or Unit required for connection
CP Series	CP1L-L14D CP1L-L20D CP1L-M30D CP1L-M40D CP1H-X CP1H-XA CP1H-Y	CP1W-CIF11 RS-422A/485 Option Board
CS Series	CS1G-CPU42(-V1) CS1G-CPU43(-V1) CS1G-CPU44(-V1) CS1G-CPU45(-V1) CS1H-CPU63(-V1) CS1H-CPU64(-V1) CS1H-CPU65(-V1) CS1H-CPU66(-V1) CS1H-CPU67(-V1) CS1G-CPU42H CS1G-CPU43H CS1G-CPU44H CS1G-CPU45H CS1H-CPU63H CS1H-CPU64H CS1H-CPU65H CS1H-CPU66H CS1H-CPU67H CS1D-CPU65H CS1D-CPU67H	CS1W-SCB41 Serial Communications Board
CJ Series	CJ1G-CPU42H CJ1G-CPU43H CJ1G-CPU44H CJ1G-CPU45H CJ1M-CPU11 CJ1M-CPU12 CJ1M-CPU13 CJ1M-CPU21 CJ1M-CPU22 CJ1M-CPU23 CJ1H-CPU65H CJ1H-CPU66H	CJ1W-SCU41 Serial Communications Unit
C Series	C200HE-CPU32(-Z) C200HE-CPU42(-Z)	C200HW-COM03/COM06(-V1) Communications Board
	C200HG-CPU33(-Z) C200HG-CPU43(-Z) C200HG-CPU53(-Z) C200HG-CPU63(-Z)	
	C200HX-CPU34(-Z) C200HX-CPU44(-Z) C200HX-CPU54(-Z) C200HX-CPU64(-Z) C200HX-CPU65-Z C200HX-CPU85-Z	
	CQM1H-CPU21 CQM1H-CPU51 CQM1H-CPU61	

Reference Both the normal 1:N NT Links and high-speed NT Links are supported for CS-series PLC CPU Units with “-V1” in the model number. If a Serial Communications Unit or Board with Lot.991220 or later is used, these connections are also supported by CPU Units without “-V1.” Refer to *3-6 High-speed 1:N NT Links* for de-tails.

CPU Units That Connect to PTs in High-speed 1:N NT Links

Model	Specifications
CP Series	Connecting to RS-232C cable using a CP1W-CIF01RS-232C Option Board Connecting RS-422A/485 Option Board (CP1W-CIF11).
CS Series (See note.)	With RS-232C connector (9-pin type)
CJ Series	With RS-232C connector (9-pin type)

Note Connection is not possible for CPU Units without “-V1” in the model number.

CPU Units That Connect in 1:N NT Links via RS-232C to PT Serial Ports

PLC Series	Connecting with built-in ports	Connecting via optional Communications Boards
CP Series	---	CP1L-L14D/L20D/M30D/ M40D (See note 1.) CP1H-X/XA/Y
CS Series	CS1G-CPU42-V1 (See note 2.) CS1G-CPU43-V1 (See note 2.) CS1G-CPU44-V1 (See note 2.) CS1G-CPU45-V1 (See note 2.) CS1H-CPU63-V1 (See note 2.) CS1H-CPU64-V1 (See note 2.) CS1H-CPU65-V1 (See note 2.) CS1H-CPU66-V1 (See note 2.) CS1H-CPU67-V1 (See note 2.) CS1G-CPU42H CS1G-CPU43H CS1G-CPU44H CS1G-CPU45H CS1H-CPU63H CS1H-CPU64H CS1H-CPU65H CS1H-CPU66H CS1H-CPU67H CS1D-CPU65H CS1D-CPU67H	Same as at left. (See note 3.)
CJ Series	CJ1G-CPU42H CJ1G-CPU43H CJ1G-CPU44H CJ1G-CPU45H CJ1M-CPU11 CJ1M-CPU12 CJ1M-CPU13 CJ1M-CPU21 CJ1M-CPU22 CJ1M-CPU23 CJ1H-CPU65H CJ1H-CPU66H	Same as at left. (See note 4.)

- Note**
- (1) CP1W-CIF01 RS-232C option board is required.
 - (2) CS-series PLC CPU Units without “-V1” in the model number do not support high-speed NT Links.
 - (3) A CS1W-SCB21/SCB41 Serial Communications Board or a CS1W-SCU21 Serial Communications Unit is required.
 - (4) A CJ1W-SCU41 Serial Communications Board is required.

CPU Units That Connect in 1:N NT Links via RS-442A/485 to PT Serial Ports

PLC Series	Unit	Serial Communications Board or Unit required for connection
CP Series	CP1L-L14D CP1L-L20D CP1L-M30D CP1L-M40D CP1H-X CP1H-XA CP1H-Y	CP1W-CIF01 RS-232C Option Board
CS Series	CS1G-CPU42(-V1) CS1G-CPU43(-V1) CS1G-CPU44(-V1) CS1G-CPU45(-V1) CS1H-CPU63(-V1) CS1H-CPU64(-V1) CS1H-CPU65(-V1) CS1H-CPU66(-V1) CS1H-CPU67(-V1) CS1G-CPU42H CS1G-CPU43H CS1G-CPU44H CS1G-CPU45H CS1H-CPU63H CS1H-CPU64H CS1H-CPU65H CS1H-CPU66H CS1H-CPU67H CS1D-CPU65H CS1D-CPU67H	CS1W-SCB41 Serial Communications Board
CJ Series	CJ1G-CPU42H CJ1G-CPU43H CJ1G-CPU44H CJ1G-CPU45H CJ1M-CPU11 CJ1M-CPU12 CJ1M-CPU13 CJ1M-CPU21 CJ1M-CPU22 CJ1M-CPU23 CJ1H-CPU65H CJ1H-CPU66H	CJ1W-SCU41 Serial Communications Unit

CPU Units That Connect to PTs in Host Links

PLC Series	Specifications
C200HE/HG/HX Series	With RS-232C connector (switching/9-pin type)
CQM1(H) Series	With RS-232C connector (9-pin type)
CPM1A Series	Connects to RS-232C cable using RS-232C Adapter CPM1-CIF01.
CPM2A Series	With RS-232C connector (9-pin type)
CPM2C Series	Connects to RS-232C connector branched using CPM2C-CN111 with converting cable.
CVM1/CV Series	With RS-232C connector (switching/9-pin type)
CS Series	With RS-232C connector (9-pin type)
CJ Series	With RS-232C connector (9-pin type)

CPU Units That Connect in Host Links via RS-232C to PT Serial Ports

PLC Series	CPU Units with Built-in Host Link Function	CPU Units Connectable with Host Link Units or Expansion Communications Board	Host Link Unit/ Communications Board
CP Series	CP1L-L14D/L20D/M30D/ M40D CP1H-X/XA/Y	---	CP1W-CIF01
C Series	---	C1000H-CPU01-EV1 C2000H-CPU01-EV1	C120-LK201-EV1
	---	C200HE-CPU11-E C200HE-CPU32-E C200HE-CPU42-E C200HE-CPU11-ZE C200HE-CPU32-ZE C200HE-CPU42-ZE C200HG-CPU33-E C200HG-CPU43-E C200HG-CPU53-E C200HG-CPU63-E C200HG-CPU33-ZE C200HG-CPU43-ZE C200HG-CPU53-ZE C200HG-CPU63-ZE C200HX-CPU34-E C200HX-CPU44-E C200HX-CPU54-E C200HX-CPU64-E C200HX-CPU34-ZE C200HX-CPU44-ZE C200HX-CPU54-ZE C200HX-CPU64-ZE C200HX-CPU65-ZE C200HX-CPU85-ZE	C200H-LK201-EV1

PLC Series	CPU Units with Built-in Host Link Function	CPU Units Connectable with Host Link Units or Expansion Communications Board	Host Link Unit/ Communications Board
C Series	C200HE-CPU42-E C200HE-CPU42-ZE	C200HE-CPU32-E C200HE-CPU42-E C200HE-CPU32-ZE C200HE-CPU42-ZE	C200HW-COM02-EV1 C200HW-COM04-EV1 C200HW-COM05-EV1 C200HW-COM06-EV1
	C200HG-CPU43-E C200HG-CPU63-E C200HG-CPU43-ZE C200HG-CPU63-ZE	C200HG-CPU33-E C200HG-CPU43-E C200HG-CPU53-E C200HG-CPU63-E C200HG-CPU33-ZE C200HG-CPU43-ZE C200HG-CPU53-ZE C200HG-CPU63-ZE	
	C200HX-CPU44-E C200HX-CPU64-E C200HX-CPU44-ZE C200HX-CPU64-ZE C200HX-CPU65-ZE C200HX-CPU85-ZE	C200HX-CPU34-E C200HX-CPU44-E C200HX-CPU54-E C200HX-CPU64-E C200HX-CPU34-ZE C200HX-CPU44-ZE C200HX-CPU54-ZE C200HX-CPU64-ZE C200HX-CPU65-ZE C200HX-CPU85-ZE	
	---	C1000H-CPU01-EV1 C2000H-CPU01-EV1	C500-LK201-EV1
	---	C1000H-CPU01-EV1 C1000HF-CPUA1-EV1 C2000H-CPU01-EV1	C500-LK203
	CPM1-10CDR-□ CPM1-20CDR-□ +CPM1-CIF01	---	---
	CPM1A-10CD□-□ CPM1A-20CD□-□ CPM1A-30CD□-□ CPM1A-40CD□-□ +CPM1-CIF01	---	---
	CPM2A-30CD□□-□ CPM2A-40CD□□-□ CPM2A-60CD□□-□ +CPM1- CIF01 (Peripheral port connection)	---	---
	CPM2C-10□□□□□□-□ CPM2C-20□□□□□□-□ (See note1.)	---	---
	CQM1-CPU21-E CQM1-CPU41-EV1 CQM1-CPU42-EV1 CQM1-CPU43-EV1 CQM1-CPU44-EV1	---	---
CQM1H-CPU11 CQM1H-CPU21 CQM1H-CPU51 CQM1H-CPU61 (See note 2.)	CQM1H-CPU51 CQM1H-CPU61	CQM1H-SCB41	
CV Series (See note 3.)	CV500-CPU01-EV1 CV1000-CPU01-EV1 CV2000-CPU01-EV1	CV500-CPU01-EV1 CV1000-CPU01-EV1 CV2000-CPU01-EV1	CV500-LK201

PLC Series	CPU Units with Built-in Host Link Function	CPU Units Connectable with Host Link Units or Expansion Communications Board	Host Link Unit/ Communications Board
CVM1 Series (See note 3.)	CVM1-CPU01-EV2 CVM1-CPU11-EV2 CVM1-CPU21-EV2	CVM1-CPU01-EV2 CVM1-CPU11-EV2 CVM1-CPU21-EV2	CV500-LK201
CS Series	CS1G-CPU42-EV1 CS1G-CPU43-EV1 CS1G-CPU44-EV1 CS1G-CPU45-EV1 CS1H-CPU63-EV1 CS1H-CPU64-EV1 CS1H-CPU65-EV1 CS1H-CPU66-EV1 CS1H-CPU67-EV1	CS1G-CPU42-EV1 CS1G-CPU43-EV1 CS1G-CPU44-EV1 CS1G-CPU45-EV1 CS1H-CPU63-EV1 CS1H-CPU64-EV1 CS1H-CPU65-EV1 CS1H-CPU66-EV1 CS1H-CPU67-EV1	CS1W-SCU21-V1 CS1W-SCB21-V1 CS1W-SCB41-V1
	CS1G-CPU42H CS1G-CPU43H CS1G-CPU44H CS1G-CPU45H CS1H-CPU63H CS1H-CPU64H CS1H-CPU65H CS1H-CPU66H CS1H-CPU67H	CS1G-CPU42H CS1G-CPU43H CS1G-CPU44H CS1G-CPU45H CS1H-CPU63H CS1H-CPU64H CS1H-CPU65H CS1H-CPU66H CS1H-CPU67H	
CJ Series	CJ1G-CPU44 CJ1G-CPU45	CJ1G-CPU44 CJ1G-CPU45	CJ1W-SCU21-V1 CJ1W-SCU41-V1
	CJ1G-CPU42H CJ1G-CPU43H CJ1G-CPU44H CJ1G-CPU45H CJ1H-CPU65H CJ1H-CPU66H CJ1H-CPU67H	CJ1G-CPU42H CJ1G-CPU43H CJ1G-CPU44H CJ1G-CPU45H CJ1H-CPU65H CJ1H-CPU66H CJ1H-CPU67H	
	CJ1M-CPU11 CJ1M-CPU12 CJ1M-CPU13 CJ1M-CPU21 CJ1M-CPU22 CJ1M-CPU23	CJ1M-CPU11 CJ1M-CPU12 CJ1M-CPU13 CJ1M-CPU21 CJ1M-CPU22 CJ1M-CPU23	
SRM1	SRM1-C02-V2	---	---

- Note**
- (1) Use a CPM2C-CN111 or CS1W-CN114/118 Connecting Cable, CPM1-CIF01 RS-232C Adapter, or CPM1-CIF11 RS-422A Adapter to connect.
 - (2) The CQM1H-CPU11 does not have a built-in RS-232C port, so connect to the peripheral port to the PT with a CS1W-CN118 Connecting Cable.
 - (3) CPU Units of CVM1/CV-series PLCs without the suffix -EV□ cannot be connected.

CPU Units That Connect in Host Link via RS-422A/485 to PT Serial Ports

PLC Series	CPU Units with Built-in Host Link Function	CPU Units Connectable with Host Link Units or Expansion Communications Board	Host Link Unit/ Communications Board
CP Series	CP1L-L14D CP1L-L20D CP1L-M30D CP1L-M40D CP1H-X CP1H-XA CP1H-Y	---	CP1W-CIF11
C Series	---	C1000H-CPU01-EV1 C2000H-CPU01-EV1	C120-LK201-EV1
	---	C200HE-CPU11-E C200HE-CPU32-E C200HE-CPU42-E C200HE-CPU11-ZE C200HE-CPU32-ZE C200HE-CPU42-ZE C200HG-CPU33-E C200HG-CPU43-E C200HG-CPU53-E C200HG-CPU63-E C200HG-CPU33-ZE C200HG-CPU43-ZE C200HG-CPU53-ZE C200HG-CPU63-ZE C200HX-CPU34-E C200HX-CPU44-E C200HX-CPU54-E C200HX-CPU64-E C200HX- CPU34-ZE C200HX- CPU44-ZE C200HX- CPU54-ZE C200HX- CPU64-ZE C200HX- CPU65-ZE C200HX- CPU85-ZE	C200H-LK202-EV1
	---	C200HE-CPU32-E C200HE-CPU42-E C200HE-CPU32-ZE C200HE-CPU42-ZE	C200HW-COM03-EV1 C200HW-COM06-EV1
	---	C200HG-CPU33-E C200HG-CPU43-E C200HG-CPU53-E C200HG-CPU63-E C200HG-CPU33-ZE C200HG-CPU43-ZE C200HG-CPU53-ZE C200HG-CPU63-ZE	
	---	C200HX-CPU34-E C200HX-CPU44-E C200HX-CPU54-E C200HX-CPU64-E C200HX- CPU34-ZE C200HX- CPU44-ZE C200HX- CPU54-ZE C200HX- CPU64-ZE C200HX- CPU65-ZE C200HX- CPU85-ZE	

PLC Series	CPU Units with Built-in Host Link Function	CPU Units Connectable with Host Link Units or Expansion Communications Board	Host Link Unit/ Communications Board
C Series	---	C1000H-CPU01-EV1 C2000H-CPU01-EV1	C500-LK201-EV1
	---	C1000H-CPU01-EV1 C1000HF-CPUA1-EV1 C2000H-CPU01-EV1	C500-LK203
	CPM1-10/20CDR-□ +CPM1-CIF11	---	---
	CPM1A-10/20/30/40CD□-□ +CPM1-CIF11	---	---
	CPM2A-30/40/60CD□□-□ +CPM1-CIF11 (Peripheral port connection)	---	---
	CPM2C-10/20□□□□□□-□ (See note 1.)	---	---
CV Series (See note 2.)	CV500-CPU01-EV1	CV500-CPU01-EV1	CV500-LK201
	CV1000-CPU01-EV1	CV1000-CPU01-EV1	
	CV2000-CPU01-EV1	CV2000-CPU01-EV1	
CVM1 Series (See note 2.)	CVM1-CPU01-EV2 CVM1-CPU11-EV2 CVM1-CPU21-EV2	CVM1-CPU01-EV2 CVM1-CPU11-EV2 CVM1-CPU21-EV2	CV500-LK201
CS Series	---	CS1G-CPU42-EV1 CS1G-CPU43-EV1 CS1G-CPU44-EV1 CS1G-CPU45-EV1 CS1H-CPU63-EV1 CS1H-CPU64-EV1 CS1H-CPU65-EV1 CS1H-CPU66-EV1 CS1H-CPU67-EV1	CS1W-SCB41-V1
	---	CS1G-CPU42H CS1G-CPU43H CS1G-CPU44H CS1G-CPU45H CS1H-CPU63H CS1H-CPU64H CS1H-CPU65H CS1H-CPU66H CS1H-CPU67H	
CJ Series	---	CJ1G-CPU44 CJ1G-CPU45	CJ1W-SCU41-V1
	---	CJ1G-CPU42H CJ1G-CPU43H CJ1G-CPU44H CJ1G-CPU45H CJ1H-CPU65H CJ1H-CPU66H CJ1H-CPU67H	
	---	CJ1M-CPU11 CJ1M-CPU12 CJ1M-CPU13 CJ1M-CPU21 CJ1M-CPU22 CJ1M-CPU23	
SRM1	SRM1-C02-V2 +CPM1-CIF11	---	---

- Note** (1) Use a CPM2C-CN111 or CS1W-CN114/118 Connecting Cable, CPM1-CIF01 RS-232C Adapter, or CPM1-CIF11 RS-422A Adapter to connect.
- (2) CPU Units of CVM1/CV-series PLCs without the suffix -EV□ cannot be connected.

Software Related to NP-series PTs

Name	Model	Details
NP-Designer	NP-NPDC0-V1	For Windows 2000 (Service Pack 4) or XP (Service Pack 2). The NP-Designer contains a transfer program and standard system program for NP-series PTs.

Connecting Cables and Connectors

Cable with Connector (PT-to-PLC)

Model	Cable length	Applicable Units	Communications method	Specifications
XW2Z-200T	2 m	Units with 9-pin connector.	NT Link (RS-232C only)	9-pin-to-9-pin
XW2Z-500T	5 m			
XW2Z-200T-2	2 m	CPM2C peripheral port	NT Link (RS-232C only)	9-pin-to-CPM2C peripheral port
XW2Z-500T-2	5 m			

Cable with Connector (PT-to-Personal Computer)

Model	Cable length	Applicable computer	Specifications
XW2Z-S002	2 m	DOS computers	Female 9-pin-to-male 9-pin

RS-232C Connecting Cable

Model	Specifications
AWG28 × 5P IFVV-SB	Multiconductor shielded cable Manufactured by Fujikura Densen.
CO-MA-VV-SB 5P × 28AWG	Multiconductor shielded cable Manufactured by Hitachi Densen.

Applicable Connectors for RS-232C

Name	Model	Specifications	Provided with
Connector	XM2A-2501	25-pin type (male), Manufactured by OMRON.	CV500-LK201 C200H-LK201-V1
	XM2D-2501	25-pin type (female), Manufactured by OMRON. (for DOS computers)	
	XM2A-0901	9-pin type (male), Manufactured by OMRON.	CS/CJ Series C Series CQM1, C200HX/HG/HE(-Z) CVM1/CV Series CPU unit CV500-LK201
	XM2D-0901	9-pin type (female), Manufactured by OMRON. (for DOS computers)	
	DB-25P	25-pin type (male), Manufactured by JAE.	

Name	Model	Specifications	Provided with
Connector hood	XM2S-2511	25-pin type, mm screws, Manufactured by OMRON.	CV500-LK201 C200H-LK201-V1
	XM2S-2513	25-pin type, inch screws, Manufactured by OMRON.	
	XM2S-0911	9-pin type, mm screws, Manufactured by OMRON.	C Series CQM1, C200HX/HG/HE(-Z) CVM1/CV Series CPU unit CV500-LK201
	XM2S-0911-E	9-pin type, mm screws, Manufactured by OMRON.	CS/CJ Series
	XM2S-0913	9-pin type, inch screws, Manufactured by OMRON.	
	DB-C2-J9	25-pin type, Manufactured by JAE.	

RS-422A/485 Connecting Cable

Manufacturer	Model
Tachii Electric Wire Co., Ltd.	TKV VBS3P-03
HIRAKAWA HEWTECH CORP.	CO-HC-ESV-3P×7/0.2

Cables for CS1-series PLC Peripheral Port

Model	Specifications
CS1W-CN118	Manufactured by OMRON (CS1-series peripheral port-to-D-Sub female 9-pin connector)

Appendix F

List of Optional Products

Replacement Battery

This is a lithium battery for backing up the contents of the memory.

Manufacturer	Model
OMRON	CJ1W-BAT01

USB Flash Memory

FAT32 formatted USB flash memory can only be connected.

Manufacturer	Model
OMRON	ZF-MEM1G

Protective Sheet

The NP3-KBA04 Protective Sheet keeps the display panel of the NP-series PT free from smudges and scratches. Protective Sheets have a matt finish to reduce glare from reflected light.

Manufacturer	Model	Remark
OMRON	NT30-KBA04	For NP5
OMRON	NP3-KBA04	For NP3

Specifications

Material: Polyester film

Chemical Resistance

Resistance	Resistant to boric acid, Hexane, Kerosene, Engine oil, Diesel oil, Lubricants, Glycerin, Silicone grease.
Non-resistance	Not resistant to ammonia solution, Sulfurous acid gas, Caustic potash, Sodium hydroxide, Phenol, Propylene, Nitrobenzene.

Revision History

A manual revision code appears as a suffix to the catalog number on the cover of the manual.

Cat. No. V096-E1-03



Revision code

The following table outlines the changes made to the manual during each revision. Page numbers refer to the previous version.

Revision code	Date	Revised content
01	July 2008	Original production
02	January 2009	Revised to correct mistakes.
03	April 2009	Revised to correct mistakes.

Revision History

Terms and Conditions of Sale

1. **Offer; Acceptance.** These terms and conditions (these "Terms") are deemed part of all quotes, agreements, purchase orders, acknowledgments, price lists, catalogs, manuals, brochures and other documents, whether electronic or in writing, relating to the sale of products or services (collectively, the "Products") by Omron Electronics LLC and its subsidiary companies ("Omron"). Omron objects to any terms or conditions proposed in Buyer's purchase order or other documents which are inconsistent with, or in addition to, these Terms.
2. **Prices; Payment Terms.** All prices stated are current, subject to change without notice by Omron. Omron reserves the right to increase or decrease prices on any unshipped portions of outstanding orders. Payments for Products are due net 30 days unless otherwise stated in the invoice.
3. **Discounts.** Cash discounts, if any, will apply only on the net amount of invoices sent to Buyer after deducting transportation charges, taxes and duties, and will be allowed only if (i) the invoice is paid according to Omron's payment terms and (ii) Buyer has no past due amounts.
4. **Interest.** Omron, at its option, may charge Buyer 1-1/2% interest per month or the maximum legal rate, whichever is less, on any balance not paid within the stated terms.
5. **Orders.** Omron will accept no order less than \$200 net billing.
6. **Governmental Approvals.** Buyer shall be responsible for, and shall bear all costs involved in, obtaining any government approvals required for the importation or sale of the Products.
7. **Taxes.** All taxes, duties and other governmental charges (other than general real property and income taxes), including any interest or penalties thereon, imposed directly or indirectly on Omron or required to be collected directly or indirectly by Omron for the manufacture, production, sale, delivery, importation, consumption or use of the Products sold hereunder (including customs duties and sales, excise, use, turnover and license taxes) shall be charged to and remitted by Buyer to Omron.
8. **Financial.** If the financial position of Buyer at any time becomes unsatisfactory to Omron, Omron reserves the right to stop shipments or require satisfactory security or payment in advance. If Buyer fails to make payment or otherwise comply with these Terms or any related agreement, Omron may (without liability and in addition to other remedies) cancel any unshipped portion of Products sold hereunder and stop any Products in transit until Buyer pays all amounts, including amounts payable hereunder, whether or not then due, which are owing to it by Buyer. Buyer shall in any event remain liable for all unpaid accounts.
9. **Cancellation; Etc.** Orders are not subject to rescheduling or cancellation unless Buyer indemnifies Omron against all related costs or expenses.
10. **Force Majeure.** Omron shall not be liable for any delay or failure in delivery resulting from causes beyond its control, including earthquakes, fires, floods, strikes or other labor disputes, shortage of labor or materials, accidents to machinery, acts of sabotage, riots, delay in or lack of transportation or the requirements of any government authority.
11. **Shipping; Delivery.** Unless otherwise expressly agreed in writing by Omron:
 - a. Shipments shall be by a carrier selected by Omron; Omron will not drop ship except in "break down" situations.
 - b. Such carrier shall act as the agent of Buyer and delivery to such carrier shall constitute delivery to Buyer;
 - c. All sales and shipments of Products shall be FOB shipping point (unless otherwise stated in writing by Omron), at which point title and risk of loss shall pass from Omron to Buyer; provided that Omron shall retain a security interest in the Products until the full purchase price is paid;
 - d. Delivery and shipping dates are estimates only; and
 - e. Omron will package Products as it deems proper for protection against normal handling and extra charges apply to special conditions.
12. **Claims.** Any claim by Buyer against Omron for shortage or damage to the Products occurring before delivery to the carrier must be presented in writing to Omron within 30 days of receipt of shipment and include the original transportation bill signed by the carrier noting that the carrier received the Products from Omron in the condition claimed.
13. **Warranties.** (a) **Exclusive Warranty.** Omron's exclusive warranty is that the Products will be free from defects in materials and workmanship for a period of twelve months from the date of sale by Omron (or such other period expressed in writing by Omron). Omron disclaims all other warranties, express or implied. (b) **Limitations.** OMRON MAKES NO WARRANTY OR REPRESENTATION, EXPRESS OR IMPLIED, ABOUT NON-INFRINGEMENT, MERCHANTABILITY OR FITNESS FOR A PARTICULAR PURPOSE OF THE PRODUCTS. BUYER ACKNOWLEDGES THAT IT ALONE HAS DETERMINED THAT THE PRODUCTS WILL SUITABLY MEET THE REQUIREMENTS OF THEIR INTENDED USE. Omron further disclaims all warranties and responsibility of any type for claims or expenses based on infringement by the Products or otherwise of any intellectual property right. (c) **Buyer Remedy.** Omron's sole obligation hereunder shall be, at Omron's election, to (i) replace (in the form originally shipped with Buyer responsible for labor charges for removal or replacement thereof) the non-complying Product, (ii) repair the non-complying Product, or (iii) repay or credit Buyer an amount equal to the purchase price of the non-complying Product; provided that in no event shall Omron be responsible for warranty, repair, indemnity or any other claims or expenses regarding the Products unless Omron's analysis confirms that the Products were properly handled, stored, installed and maintained and not subject to contamination, abuse, misuse or inappropriate modification. Return of any Products by Buyer must be approved in writing by Omron before shipment. Omron Companies shall not be liable for the suitability or unsuitability or the results from the use of Products in combination with any electrical or electronic components, circuits, system assemblies or any other materials or substances or environments. Any advice, recommendations or information given orally or in writing, are not to be construed as an amendment or addition to the above warranty. See <http://www.omron247.com> or contact your Omron representative for published information.
14. **Limitation on Liability; Etc.** OMRON COMPANIES SHALL NOT BE LIABLE FOR SPECIAL, INDIRECT, INCIDENTAL, OR CONSEQUENTIAL DAMAGES, LOSS OF PROFITS OR PRODUCTION OR COMMERCIAL LOSS IN ANY WAY CONNECTED WITH THE PRODUCTS, WHETHER SUCH CLAIM IS BASED IN CONTRACT, WARRANTY, NEGLIGENCE OR STRICT LIABILITY. Further, in no event shall liability of Omron Companies exceed the individual price of the Product on which liability is asserted.
15. **Indemnities.** Buyer shall indemnify and hold harmless Omron Companies and their employees from and against all liabilities, losses, claims, costs and expenses (including attorney's fees and expenses) related to any claim, investigation, litigation or proceeding (whether or not Omron is a party) which arises or is alleged to arise from Buyer's acts or omissions under these Terms or in any way with respect to the Products. Without limiting the foregoing, Buyer (at its own expense) shall indemnify and hold harmless Omron and defend or settle any action brought against such Companies to the extent based on a claim that any Product made to Buyer specifications infringed intellectual property rights of another party.
16. **Property; Confidentiality.** Any intellectual property in the Products is the exclusive property of Omron Companies and Buyer shall not attempt to duplicate it in any way without the written permission of Omron. Notwithstanding any charges to Buyer for engineering or tooling, all engineering and tooling shall remain the exclusive property of Omron. All information and materials supplied by Omron to Buyer relating to the Products are confidential and proprietary, and Buyer shall limit distribution thereof to its trusted employees and strictly prevent disclosure to any third party.
17. **Export Controls.** Buyer shall comply with all applicable laws, regulations and licenses regarding (i) export of products or information; (ii) sale of products to "forbidden" or other proscribed persons; and (iii) disclosure to non-citizens of regulated technology or information.
18. **Miscellaneous.** (a) **Waiver.** No failure or delay by Omron in exercising any right and no course of dealing between Buyer and Omron shall operate as a waiver of rights by Omron. (b) **Assignment.** Buyer may not assign its rights hereunder without Omron's written consent. (c) **Law.** These Terms are governed by the law of the jurisdiction of the home office of the Omron company from which Buyer is purchasing the Products (without regard to conflict of law principles). (d) **Amendment.** These Terms constitute the entire agreement between Buyer and Omron relating to the Products, and no provision may be changed or waived unless in writing signed by the parties. (e) **Severability.** If any provision hereof is rendered ineffective or invalid, such provision shall not invalidate any other provision. (f) **Setoff.** Buyer shall have no right to set off any amounts against the amount owing in respect of this invoice. (g) **Definitions.** As used herein, "including" means "including without limitation"; and "Omron Companies" (or similar words) mean Omron Corporation and any direct or indirect subsidiary or affiliate thereof.

Certain Precautions on Specifications and Use

1. **Suitability of Use.** Omron Companies shall not be responsible for conformity with any standards, codes or regulations which apply to the combination of the Product in the Buyer's application or use of the Product. At Buyer's request, Omron will provide applicable third party certification documents identifying ratings and limitations of use which apply to the Product. This information by itself is not sufficient for a complete determination of the suitability of the Product in combination with the end product, machine, system, or other application or use. Buyer shall be solely responsible for determining appropriateness of the particular Product with respect to Buyer's application, product or system. Buyer shall take application responsibility in all cases but the following is a non-exhaustive list of applications for which particular attention must be given:
 - (i) Outdoor use, uses involving potential chemical contamination or electrical interference, or conditions or uses not described in this document.
 - (ii) Use in consumer products or any use in significant quantities.
 - (iii) Energy control systems, combustion systems, railroad systems, aviation systems, medical equipment, amusement machines, vehicles, safety equipment, and installations subject to separate industry or government regulations.
 - (iv) Systems, machines and equipment that could present a risk to life or property. Please know and observe all prohibitions of use applicable to this Product.

NEVER USE THE PRODUCT FOR AN APPLICATION INVOLVING SERIOUS RISK TO LIFE OR PROPERTY OR IN LARGE QUANTITIES WITHOUT ENSURING THAT THE SYSTEM AS A WHOLE HAS BEEN DESIGNED TO ADDRESS THE RISKS, AND THAT THE OMRON'S PRODUCT IS PROPERLY RATED AND INSTALLED FOR THE INTENDED USE WITHIN THE OVERALL EQUIPMENT OR SYSTEM.
2. **Programmable Products.** Omron Companies shall not be responsible for the user's programming of a programmable Product, or any consequence thereof.
3. **Performance Data.** Data presented in Omron Company websites, catalogs and other materials is provided as a guide for the user in determining suitability and does not constitute a warranty. It may represent the result of Omron's test conditions, and the user must correlate it to actual application requirements. Actual performance is subject to the Omron's Warranty and Limitations of Liability.
4. **Change in Specifications.** Product specifications and accessories may be changed at any time based on improvements and other reasons. It is our practice to change part numbers when published ratings or features are changed, or when significant construction changes are made. However, some specifications of the Product may be changed without any notice. When in doubt, special part numbers may be assigned to fix or establish key specifications for your application. Please consult with your Omron's representative at any time to confirm actual specifications of purchased Product.
5. **Errors and Omissions.** Information presented by Omron Companies has been checked and is believed to be accurate; however, no responsibility is assumed for clerical, typographical or proofreading errors or omissions.

OMRON

Automation...simple...powerful.

OMRON ELECTRONICS LLC • THE AMERICAS HEADQUARTERS

Schaumburg, IL USA • 847.843.7900 • 800.556.6766 • www.omron247.com

OMRON CANADA, INC. • HEAD OFFICE

Toronto, ON, Canada • 416.286.6465 • 866.986.6766 • www.omron.ca

OMRON ELETRÔNICA DO BRASIL LTDA • HEAD OFFICE

São Paulo, SP, Brasil • 55.11.2101.6300 • www.omron.com.br

OMRON ELECTRONICS MEXICO SA DE CV • HEAD OFFICE

Apodaca, N.L. • 52.811.156.99.10 • mela@omron.com

OMRON ARGENTINA • SALES OFFICE

Cono Sur • 54.11.4787.1129

OMRON CHILE • SALES OFFICE

Santiago 56.2206.4592

OTHER OMRON LATIN AMERICA SALES

56.2206.4592