

**Warranty  
Registration:**

register online today for a  
chance to win a FREE Tripp Lite  
product—[www.tripplite.com/warranty](http://www.tripplite.com/warranty)



# KVM Extender USB

## Quick Start Guide



1111 W. 35th Street, Chicago, IL 60609 USA  
[www.tripplite.com/support](http://www.tripplite.com/support)

Copyright ©2012 Tripp Lite. All rights reserved.

# 1. Introduction

The KVM Extender USB system from Minicom is an advanced KVM extender that performs the following functions:

- Extends KVM control over a computer up to a distance of 150m / 500ft
- Gives 2 users at 2 workstations control of 1 computer
- A 2-port KVM switch at the remote workstation
- Full USB keyboard and mouse control

# 2. System components

The KVM Extender USB system consists of:

- Transmitter
- Receiver
- 2 x VGA+USB cable
- 1 Power adapter for the Receiver
- 1 Screwdriver
- 8 non-stick rubber stops

# 3. The KVM Extender USB units

The figures below illustrate the Transmitter unit.

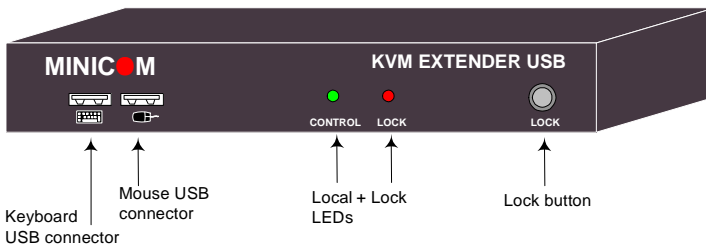
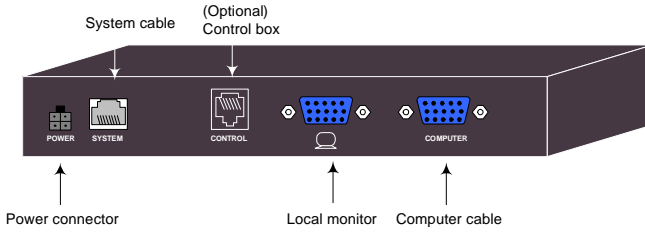

Figure 1 Transmitter front panel

## 3.1 Transmitter Button / LEDs

Button / LED	Function
Lock button	Press to keep control of the connected computer at the Transmitter position
Control LED	Blinks when Transmitter position has control of the Transmitter position computer
Lock LED	Blinks after either Transmitter or Receiver position presses the Lock button for control



**Figure 2 Transmitter back panel**

The figures below illustrate the Receiver unit. The Receiver can be up to 150m / 500ft away from the Transmitter.

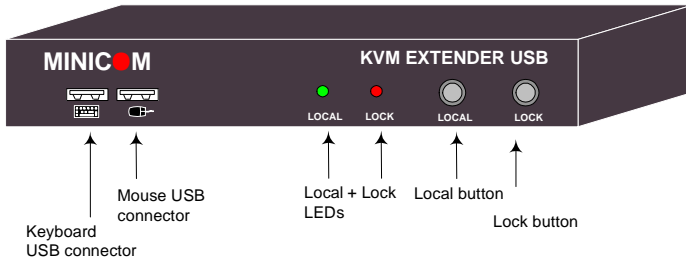

**Figure 3 Receiver front panel**

### 3.2 Receiver Buttons / LEDs

Button / LED	Function
Lock button	Press to lock control of the Transmitter computer at the Receiver position
Local button	Press to toggle control between the local Receiver computer and the remote Transmitter computer (see also section 8.1 on page 6)
Lock LED	Blinks after either Transmitter or Receiver position presses the Lock button
Local LED	Blinks when Receiver position has control of the Receiver position computer

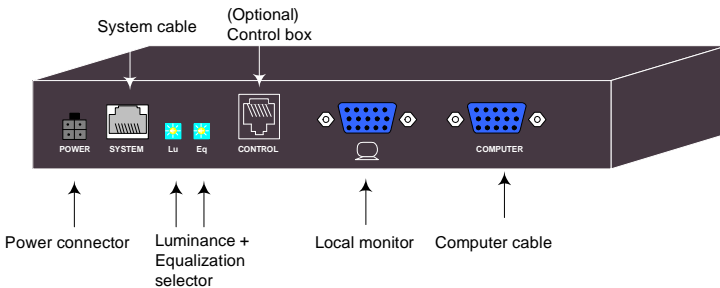

**Figure 4 Receiver back panel**

## 4. Pre-installation instructions

Place cables away from fluorescent lights, air conditioners, and machines that are likely to generate electrical noise.

## 5. Connecting the System

When using the system as an extender, extending KVM control from the computer up to a distance of 150m/500ft, connect the system as in Figure 5. The connections are explained below.

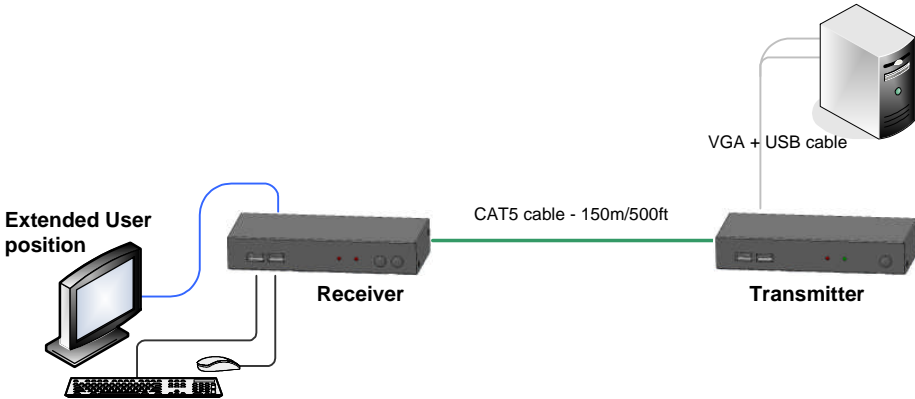

Figure 5 KVM Extender USB as an extender

### 5.1 Connecting the Transmitter

Connect a VGA + USB cable - illustrated below - to the Transmitter and a computer. Connect the HD15 connector to the Transmitter Computer port and connect the VGA and USB connectors to the local computer Monitor and USB ports.



Figure 6 VGA + USB cable

### 5.2 Connecting a KVM workstation to the Receiver

Connect a KVM workstation to the Receiver. Connect a keyboard and mouse to the Receiver Keyboard and Mouse USB ports. Connect a monitor to the Receiver Monitor port.

### 5.3 Connecting the System cable

Connect the System cable CAT5/6/7 FTP cable to the System ports of the Transmitter and Receiver.

### 5.4 Connecting to the power supply

The Transmitter receives its power from the connected computer and does not generally need an external power supply. However, when the Transmitter is connected to a KVM switch it may need an external power supply. Use a Minicom Power adapter 12VDC 1A, ordered separately p/n 5PSA70020.

Connect the Receiver to the power supply with the Power adapter and cord provided.

## 6. Extender system with optional computer at Receiver position

You can connect a computer to the Receiver position. The Receiver position can then either control the local computer or the Transmitter position computer.

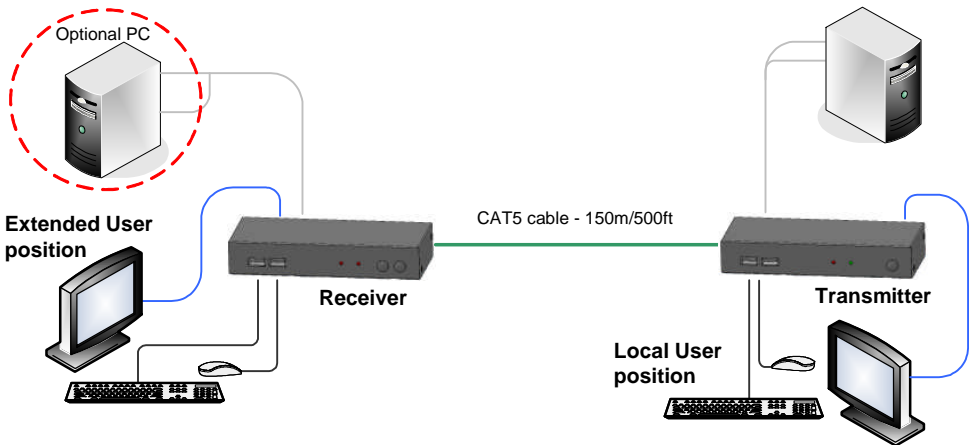

Figure 7 Extender system with optional computer at Receiver position

The connections are the same as outlined above, with the addition of a computer connected to the Receiver as follows:

### 6.1 Connecting a computer to the Receiver

Connect a VGA + USB cable to the Receiver and a computer. Connect the HD15 connector to the Receiver Computer port and connect the VGA and USB connectors to the computer Monitor and USB ports.

## 7. Extender + KVM switch system with optional computer at Receiver position

You can connect a KVM switch to the Receiver position. The Receiver position can then either control the local computer or any computer connected to the KVM switch at the Transmitter position computer.

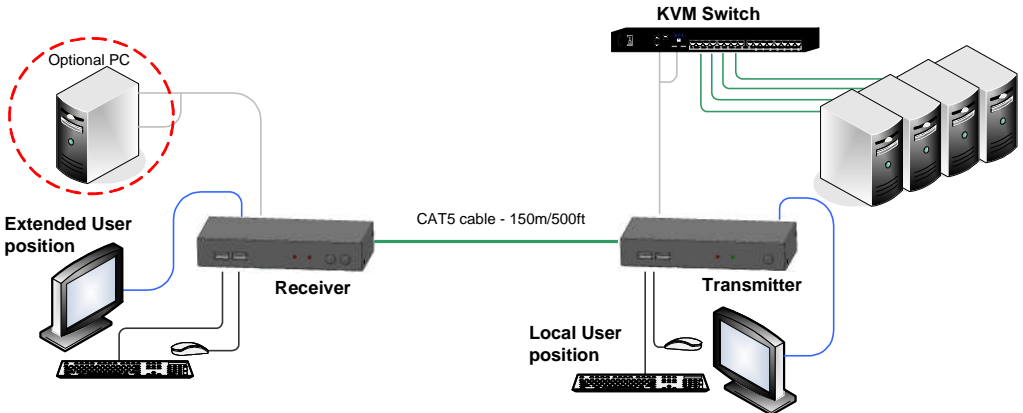

Figure 8 Extender + KVM switch with optional computer at Receiver position

The connections are the same as outlined above, with the addition of a KVM switch connected to the Transmitter as follows:

Connect a VGA + USB cable to the Transmitter and the KVM switch. Connect the HD15 connector to the Transmitter Computer port and connect the VGA and USB connectors to the KVM switch Monitor and USB ports.

## 8. Operating the KVM Extender USB system

The system works on a first come first served basis – press the keyboard or move the mouse at either the Transmitter (where relevant) or Receiver position to take control of the Transmitter position computer.

**Transmitter position:** Press the Lock button to keep/gain control of the computer at the Transmitter position. The Lock LED at the Transmitter position illuminates and blinks at the Receiver position. The Control LED at the Transmitter position illuminates.

**Receiver position:** Press the Lock button to keep control of the Transmitter computer at the Receiver position. The Lock LED at the Receiver position illuminates and blinks at the Transmitter position.

Press the Local button to gain control of the Receiver computer position. The Local LED blinks.

**Note!** You can only gain control by pressing the Lock button if the Lock LED is currently not blinking.

Re-pressing the Lock button at either position releases control and the Lock LEDs turn off.

## 8.1 Keyboard hotkeys

To toggle between the Transmitter and the Receiver position, press: **Caps Lock** twice, release, then press **C**.

To turn the beeper sound on/off, press: **Caps Lock** twice, release, then press **B**.

## 8.2 Adjusting the picture

At the Receiver, you can adjust the picture quality using a small screwdriver to turn the Luminance and Equalization Picture adjusters located on the Receiver's rear panel.

# 9. Safety

The device must only be opened by an authorized Minicom technician. Disconnect device from AC mains before service operation!

## 9.1 User guide feedback

Your feedback is very important to help us improve our documentation. Please email any comments to: [ug.comments@minicom.com](mailto:ug.comments@minicom.com)

Please include the following information: Guide name, part number and version number (as appears on the front cover).

## 9.2 WEEE compliance

WEEE Information for Minicom Customers and Recyclers

Under the Waste Electrical and Electronic Equipment (WEEE) Directive and implementing regulations, when customers buy new electrical and electronic equipment from Minicom they are entitled to:

- Send old equipment for recycling on a one-for-one, like-for-like basis (this varies depending on the country)
- Send the new equipment back for recycling when this ultimately becomes waste

Instructions to both customers and recyclers/treatment facilities wishing to obtain disassembly information are provided in our website [www.minicom.com](http://www.minicom.com).

## 10. Technical specifications

System cable	CAT5/6/7 FTP 2x4x24 AWG Solid Wire cable
Maximum distance	150m/500ft
Mouse support	USB mouse
Operating systems	All major operating systems
Management	Push button or external control unit
Screen resolution	Up to 1600X1200 @ 75Hz
Operating temperature	0°C to 40°C/32°F to 104°F
Storage temperature	-40°C to 40°C/-40°F to 104°F
Warranty	3 Years limited

	Transmitter	Receiver
Cables & connectors	HDD15F (VGA + USB cable) – for computer or KVM switch	HDD15F (VGA + USB cable) - for optional local computer
	USB X 2: for Keyboard + Mouse	USB X 2: for Keyboard + Mouse
	HDD15 : for monitor	HDD15 : for monitor
	RJ45 - System	RJ45 - System
	RJ11 - External control unit	RJ11 - External control unit
Dimensions	85 x 113 x 25mm/ 3.3 x 4.4 x 0.98 inches	85 x 49 x 25mm/ 3.3 x 4.4 x 0.98 inches
Shipping weight	1,750g/3.9lb	
Power supply	From computer or external power adapter 12VDC 1A	External power adapter 12VDC 1A

